

**Product number CA13270_LAURA-SS-WAS**

| | | | |
|-----------------|------------------|-------------|--------------------|
| Family | Laura | FWHM | Asymmetric degrees |
| Type | Assembly | Efficiency | 92 % |
| LED | LUXEON Rebel | cd/lm | 13.300 |
| Color | White | Gerber File | Available |
| Diameter | 21.6 x 21.6 mm | | |
| Height | 12.9 mm | | |
| Style | Square | | |
| Optic Material | PMMA | | |
| Holder Material | - | | |
| Fastening | ["tape"] | | |
| Status | Production ready | | |

**Product number CA13272_LAURA-O-WAS**

| | | | |
|-----------------|------------------|-------------|--------------------|
| Family | Laura | FWHM | Asymmetric degrees |
| Type | Assembly | Efficiency | (simulated) 87 % |
| LED | LUXEON Rebel | cd/lm | 3.100 |
| Color | White | Gerber File | Available |
| Diameter | 21.6 x 21.6 mm | | |
| Height | 12.9 mm | | |
| Style | Square | | |
| Optic Material | PMMA | | |
| Holder Material | - | | |
| Fastening | ["tape"] | | |
| Status | Production ready | | |

**Product number CA13307_LAURA-O-WAS-PIN**

| | | | |
|-----------------|------------------|-------------|--------------------|
| Family | Laura | FWHM | Asymmetric degrees |
| Type | Assembly | Efficiency | 87 % |
| LED | LUXEON Rebel | cd/lm | 3.100 |
| Color | White | Gerber File | Available |
| Diameter | 21.6 x 21.6 mm | | |
| Height | 13.1 mm | | |
| Style | Square | | |
| Optic Material | PMMA | | |
| Holder Material | - | | |
| Fastening | ["pin", "tape"] | | |
| Status | Production ready | | |

**Product number CP13308_LAURA-O-WAS-PG**

| | | | |
|-----------------|------------------|-------------|--------------------|
| Family | Laura | FWHM | Asymmetric degrees |
| Type | Assembly | Efficiency | 87 % |
| LED | LUXEON Rebel | cd/lm | 3.100 |
| Color | White | Gerber File | Available |
| Diameter | 21.6 x 21.6 mm | | |
| Height | 12.9 mm | | |
| Style | Square | | |
| Optic Material | PMMA,PC | | |
| Holder Material | - | | |
| Fastening | ["glue", "pin"] | | |
| Status | Production ready | | |

**Product number CP13311_LAURA-SS-WAS-PG**

| | | | |
|-----------------|------------------|-------------|--------------------|
| Family | Laura | FWHM | Asymmetric degrees |
| Type | Assembly | Efficiency | 92 % |
| LED | LUXEON Rebel | cd/lm | 13.300 |
| Color | White | Gerber File | Available |
| Diameter | 21.6 x 21.6 mm | | |
| Height | 12.9 mm | | |
| Style | Square | | |
| Optic Material | PC,PMMA | | |
| Holder Material | - | | |
| Fastening | ["glue", "pin"] | | |
| Status | Production ready | | |

**Product number CA13312_LAURA-SS-WAS-PIN**

| | | | |
|-----------------|------------------|-------------|--------------------|
| Family | Laura | FWHM | Asymmetric degrees |
| Type | Assembly | Efficiency | 92 % |
| LED | LUXEON Rebel | cd/lm | 13.300 |
| Color | White | Gerber File | Available |
| Diameter | 21.6 x 21.6 mm | | |
| Height | 13.1 mm | | |
| Style | Square | | |
| Optic Material | PMMA | | |
| Holder Material | - | | |
| Fastening | ["tape", "pin"] | | |
| Status | Production ready | | |

**Product number CX11352_LAURA-RS**

| | | | |
|-----------------|------------------|-------------|-----------|
| Family | Laura | FWHM | 7 degrees |
| Type | Pack | Efficiency | 93 % |
| LED | LUXEON Rebel | cd/lm | 34.000 |
| Color | White | Gerber File | Available |
| Diameter | 21.6 x 21.6 mm | | |
| Height | 12.9 mm | | |
| Style | Square | | |
| Optic Material | PMMA | | |
| Holder Material | - | | |
| Fastening | ["tape"] | | |
| Status | Production ready | | |

**Product number CA11959_LAURA-RS-PIN**

| | | | |
|-----------------|------------------|-------------|-----------|
| Family | Laura | FWHM | 7 degrees |
| Type | Assembly | Efficiency | 93 % |
| LED | LUXEON Rebel | cd/lm | 34.000 |
| Color | White | Gerber File | Available |
| Diameter | 21.6 x 21.6 mm | | |
| Height | 13.1 mm | | |
| Style | Square | | |
| Optic Material | PMMA | | |
| Holder Material | - | | |
| Fastening | ["tape", "pin"] | | |
| Status | Production ready | | |

**Product number CP12631_LAURA-RS-PG**

| | | | |
|-----------------|------------------|-------------|-----------|
| Family | Laura | FWHM | 7 degrees |
| Type | Assembly | Efficiency | 93 % |
| LED | LUXEON Rebel | cd/lm | 34.000 |
| Color | White | Gerber File | Available |
| Diameter | 21.6 x 21.6 mm | | |
| Height | 13.1 mm | | |
| Style | Square | | |
| Optic Material | PC,PMMA | | |
| Holder Material | - | | |
| Fastening | ["glue", "pin"] | | |
| Status | Production ready | | |

**Product number CX11645_LAURA-SS**

| | | | |
|-----------------|------------------|-------------|------------|
| Family | Laura | FWHM | 10 degrees |
| Type | Pack | Efficiency | 93 % |
| LED | LUXEON Rebel | cd/lm | 14.200 |
| Color | White | Gerber File | Available |
| Diameter | 21.6 x 21.6 mm | | |
| Height | 12.9 mm | | |
| Style | Square | | |
| Optic Material | PMMA | | |
| Holder Material | - | | |
| Fastening | ["tape"] | | |
| Status | Production ready | | |

**Product number CA12011_LAURA-SS-PIN**

| | | | |
|-----------------|------------------|-------------|------------|
| Family | Laura | FWHM | 11 degrees |
| Type | Assembly | Efficiency | 92 % |
| LED | LUXEON Rebel | cd/lm | 16.000 |
| Color | White | Gerber File | Available |
| Diameter | 21.6 x 21.6 mm | | |
| Height | 13.1 mm | | |
| Style | Square | | |
| Optic Material | PMMA | | |
| Holder Material | - | | |
| Fastening | ["tape", "pin"] | | |
| Status | Production ready | | |

**Product number CP12634_LAURA-SS-PG**

| | | | |
|-----------------|------------------|-------------|------------|
| Family | Laura | FWHM | 11 degrees |
| Type | Assembly | Efficiency | 92 % |
| LED | LUXEON Rebel | cd/lm | 16.000 |
| Color | White | Gerber File | Available |
| Diameter | 21.6 x 21.6 mm | | |
| Height | 13.1 mm | | |
| Style | Square | | |
| Optic Material | PMMA,PC | | |
| Holder Material | - | | |
| Fastening | ["glue", "pin"] | | |
| Status | Production ready | | |

**Product number CX11359_LAURA-D**

| | | | |
|-----------------|------------------|-------------|------------|
| Family | Laura | FWHM | 15 degrees |
| Type | Pack | Efficiency | 90 % |
| LED | LUXEON Rebel | cd/lm | 5.000 |
| Color | White | Gerber File | Available |
| Diameter | 21.6 x 21.6 mm | | |
| Height | 12.9 mm | | |
| Style | Square | | |
| Optic Material | PMMA | | |
| Holder Material | - | | |
| Fastening | ["tape"] | | |
| Status | Production ready | | |

**Product number CA11960_LAURA-D-PIN**

| | | | |
|-----------------|------------------|-------------|------------|
| Family | Laura | FWHM | 15 degrees |
| Type | Assembly | Efficiency | 90 % |
| LED | LUXEON Rebel | cd/lm | 5.000 |
| Color | White | Gerber File | Available |
| Diameter | 21.6 x 21.6 mm | | |
| Height | 13.1 mm | | |
| Style | Square | | |
| Optic Material | PMMA | | |
| Holder Material | - | | |
| Fastening | ["tape", "pin"] | | |
| Status | Production ready | | |

**Product number CP12632_LAURA-D-PG**

| | | | |
|-----------------|------------------|-------------|------------|
| Family | Laura | FWHM | 15 degrees |
| Type | Assembly | Efficiency | 90 % |
| LED | LUXEON Rebel | cd/lm | 5.000 |
| Color | White | Gerber File | Available |
| Diameter | 21.6 x 21.6 mm | | |
| Height | 13.1 mm | | |
| Style | Square | | |
| Optic Material | PC,PMMA | | |
| Holder Material | - | | |
| Fastening | ["glue", "pin"] | | |
| Status | Production ready | | |

**Product number CX11354_LAURA-M**

| | | | |
|-----------------|------------------|-------------|------------|
| Family | Laura | FWHM | 27 degrees |
| Type | Pack | Efficiency | 88 % |
| LED | LUXEON Rebel | cd/lm | 2.900 |
| Color | White | Gerber File | Available |
| Diameter | 21.6 x 21.6 mm | | |
| Height | 12.9 mm | | |
| Style | Square | | |
| Optic Material | PMMA | | |
| Holder Material | - | | |
| Fastening | ["tape"] | | |
| Status | Production ready | | |

**Product number CA11837_LAURA-M-PIN**

| | | | |
|-----------------|------------------|-------------|------------|
| Family | Laura | FWHM | 27 degrees |
| Type | Assembly | Efficiency | 88 % |
| LED | LUXEON Rebel | cd/lm | 2.900 |
| Color | White | Gerber File | Available |
| Diameter | 21.6 x 21.6 mm | | |
| Height | 13.1 mm | | |
| Style | Square | | |
| Optic Material | PMMA | | |
| Holder Material | - | | |
| Fastening | ["pin", "tape"] | | |
| Status | Production ready | | |

**Product number CP12633_LAURA-M-PG**

| | | | |
|-----------------|------------------|-------------|------------|
| Family | Laura | FWHM | 27 degrees |
| Type | Assembly | Efficiency | 88 % |
| LED | LUXEON Rebel | cd/lm | 2.900 |
| Color | White | Gerber File | Available |
| Diameter | 21.6 x 21.6 mm | | |
| Height | 13.1 mm | | |
| Style | Square | | |
| Optic Material | PMMA,PC | | |
| Holder Material | - | | |
| Fastening | ["pin", "glue"] | | |
| Status | Production ready | | |

**Product number CX12568_LAURA-W**

| | | | |
|-----------------|------------------|-------------|------------|
| Family | Laura | FWHM | 39 degrees |
| Type | Pack | Efficiency | 88 % |
| LED | LUXEON Rebel | cd/lm | 1.900 |
| Color | White | Gerber File | Available |
| Diameter | 21.6 x 21.6 mm | | |
| Height | 12.9 mm | | |
| Style | Square | | |
| Optic Material | PMMA | | |
| Holder Material | - | | |
| Fastening | ["tape"] | | |
| Status | Production ready | | |

**Product number CX11364_LAURA-O**

| | | | |
|-----------------|------------------|-------------|---------------|
| Family | Laura | FWHM | 41+12 degrees |
| Type | Pack | Efficiency | 90 % |
| LED | LUXEON Rebel | cd/lm | 5.000 |
| Color | White | Gerber File | Available |
| Diameter | 21.6 x 21.6 mm | | |
| Height | 12.9 mm | | |
| Style | Square | | |
| Optic Material | PMMA | | |
| Holder Material | - | | |
| Fastening | ["tape"] | | |
| Status | Production ready | | |

**Product number CA12012_LAURA-O-PIN**

| | | | |
|-----------------|------------------|-------------|---------------|
| Family | Laura | FWHM | 41+12 degrees |
| Type | Assembly | Efficiency | 90 % |
| LED | LUXEON Rebel | cd/lm | 5.000 |
| Color | White | Gerber File | Available |
| Diameter | 21.6 x 21.6 mm | | |
| Height | 13.1 mm | | |
| Style | Square | | |
| Optic Material | PMMA | | |
| Holder Material | - | | |
| Fastening | ["tape", "pin"] | | |
| Status | Production ready | | |

**Product number CP12635_LAURA-O-PG**

| | | | |
|-----------------|------------------|-------------|---------------|
| Family | Laura | FWHM | 41+12 degrees |
| Type | Assembly | Efficiency | 90 % |
| LED | LUXEON Rebel | cd/lm | 5.000 |
| Color | White | Gerber File | Available |
| Diameter | 21.6 x 21.6 mm | | |
| Height | 13.1 mm | | |
| Style | Square | | |
| Optic Material | PMMA,PC | | |
| Holder Material | - | | |
| Fastening | ["glue", "pin"] | | |
| Status | Production ready | | |

**Product number CA12344_LAURA-W-PIN**

| | | | |
|-----------------|------------------|-------------|------------|
| Family | Laura | FWHM | 44 degrees |
| Type | Assembly | Efficiency | 88 % |
| LED | LUXEON Rebel | cd/lm | 1.800 |
| Color | White | Gerber File | Available |
| Diameter | 21.6 x 21.6 mm | | |
| Height | 13.1 mm | | |
| Style | Square | | |
| Optic Material | PMMA | | |
| Holder Material | - | | |
| Fastening | ["tape", "pin"] | | |
| Status | Production ready | | |

**Product number CP12636_LAURA-W-PG**

| | | | |
|-----------------|------------------|-------------|------------|
| Family | Laura | FWHM | 44 degrees |
| Type | Assembly | Efficiency | 88 % |
| LED | LUXEON Rebel | cd/lm | 1.800 |
| Color | White | Gerber File | Available |
| Diameter | 21.6 x 21.6 mm | | |
| Height | 13.1 mm | | |
| Style | Square | | |
| Optic Material | PMMA,PC | | |
| Holder Material | - | | |
| Fastening | ["glue", "pin"] | | |
| Status | Production ready | | |

**Product number CA12325_LAURA-WW-PIN**

| | | | |
|-----------------|------------------|-------------|------------|
| Family | Laura | FWHM | 56 degrees |
| Type | Assembly | Efficiency | - |
| LED | LUXEON Rebel | cd/lm | 1.000 |
| Color | White | Gerber File | Available |
| Diameter | 21.6 x 21.6 mm | | |
| Height | 13.1 mm | | |
| Style | Square | | |
| Optic Material | PMMA | | |
| Holder Material | - | | |
| Fastening | ["tape", "pin"] | | |
| Status | Production ready | | |

**Product number CP12637_LAURA-WW-PG**

| | | | |
|-----------------|------------------|-------------|------------|
| Family | Laura | FWHM | 56 degrees |
| Type | Assembly | Efficiency | - |
| LED | LUXEON Rebel | cd/lm | 1.000 |
| Color | White | Gerber File | Available |
| Diameter | 21.6 x 21.6 mm | | |
| Height | 13.1 mm | | |
| Style | Square | | |
| Optic Material | PC,PMMA | | |
| Holder Material | - | | |
| Fastening | ["glue", "pin"] | | |
| Status | Production ready | | |

**Product number CX11768_LAURA-WW**

| | | | |
|-----------------|------------------|-------------|------------|
| Family | Laura | FWHM | 66 degrees |
| Type | Pack | Efficiency | 93 % |
| LED | LUXEON Rebel | cd/lm | 0.690 |
| Color | White | Gerber File | Available |
| Diameter | 21.6 x 21.6 mm | | |
| Height | 12.9 mm | | |
| Style | Square | | |
| Optic Material | PMMA | | |
| Holder Material | - | | |
| Fastening | ["tape"] | | |
| Status | Production ready | | |

**Product number CX11524_LAURA-R-W**

| | | | |
|-----------------|------------------|-------------|------------|
| Family | Laura | FWHM | 68 degrees |
| Type | RefPack | Efficiency | 81 % |
| LED | LUXEON Rebel | cd/lm | - |
| Color | White | Gerber File | Available |
| Diameter | 21.6 x 21.6 mm | | |
| Height | 12.9 mm | | |
| Style | Square | | |
| Optic Material | - | | |
| Holder Material | - | | |
| Fastening | ["tape"] | | |
| Status | Production ready | | |



Product number CX12983_LAURA-R-XW

| | | | |
|-----------------|------------------|-------------|------------|
| Family | Laura | FWHM | 71 degrees |
| Type | RefPack | Efficiency | 87 % |
| LED | LUXEON Rebel | cd/lm | 0.670 |
| Color | White | Gerber File | Available |
| Diameter | 21.6 x 21.6 mm | | |
| Height | 12.9 mm | | |
| Style | Square | | |
| Optic Material | - | | |
| Holder Material | - | | |
| Fastening | ["tape"] | | |
| Status | Production ready | | |

NOTE: The typical divergence will be changed by different color, chip size and chip position tolerance. The typical total divergence is the full angle measured where the luminous intensity is half of the peak value.



PRODUCT DATASHEET

Laura series

last update 12/5/2016

GENERAL INFORMATION

- Product series especially designed & optimized for LUXEON Rebel series of LEDs.
- Special care taken to make light distribution as uniform as possible.
- Lens material optical grade PMMA with high UV and temperature resistance. Allows use of high current and temperature conditions.

Please find more information about used material from below:

http://ledil.fi/sites/default/files/Documents/Technical/Material/PMMA%20N%20UL94_Yellow%20Card.pdf

<http://ledil.fi/sites/default/files/Documents/Technical/Material/PMMA%20N%20PLEXIGLAS-Datasheet.pdf>

Relative intensity of CX11645_LAURA-SS-RE

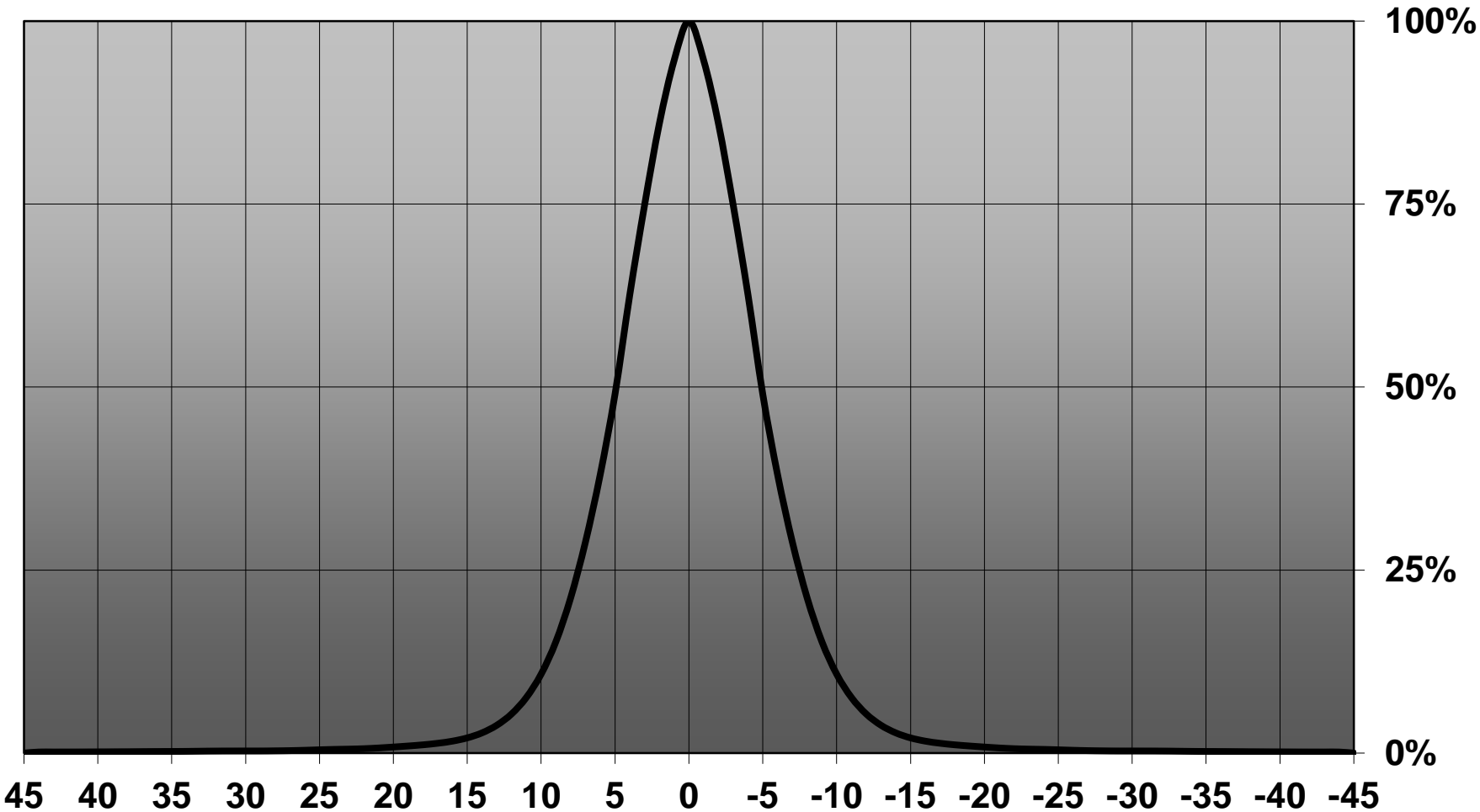

D

C

B

A

4

4

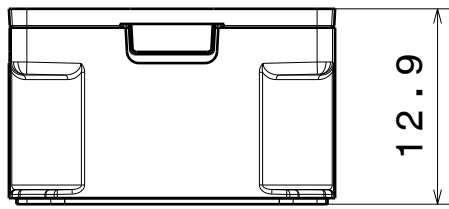

Front View

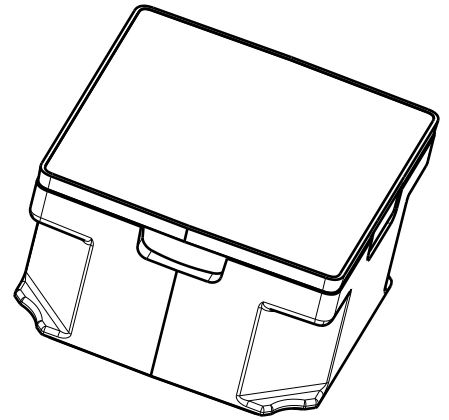

Isometric view

Oval Beam Direction

3

3

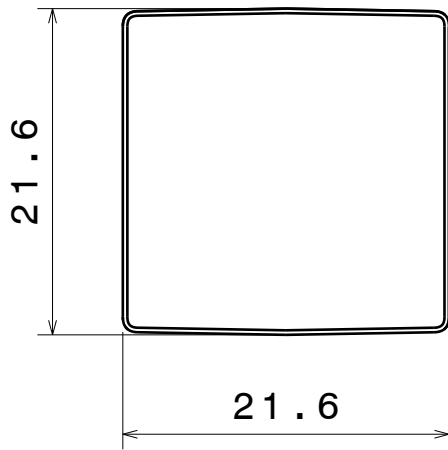

Top view

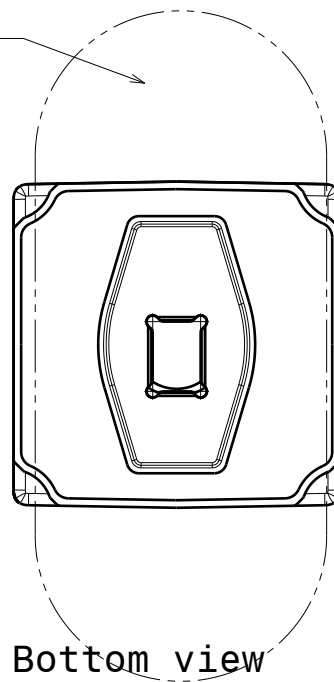

Bottom view

2

2

This drawing is our property.
It can't be reproduced
or communicated without
our written agreement.



Ledil Oy
Salorankatu 10
FIN 24240 SALO
Finland

DRAWING TITLE Mechanical Drawing

DRAWN BY
ks

DATE
08.11.2012

LAURA-RE

CHECKED BY
as

DATE
-

SIZE
A4

PART NUMBER

REV
001

DESIGNED BY
-

DATE
-

SCALE 2:1

WEIGHT

SHEET 1/1

1

1

D

A

Luminaire: Ledil Oy CA13270_LAURA-SS-WAS_(Rebel) Efficiency=92%
Lamps: 1 x Luxeon Rebel 80lm @ 250mA

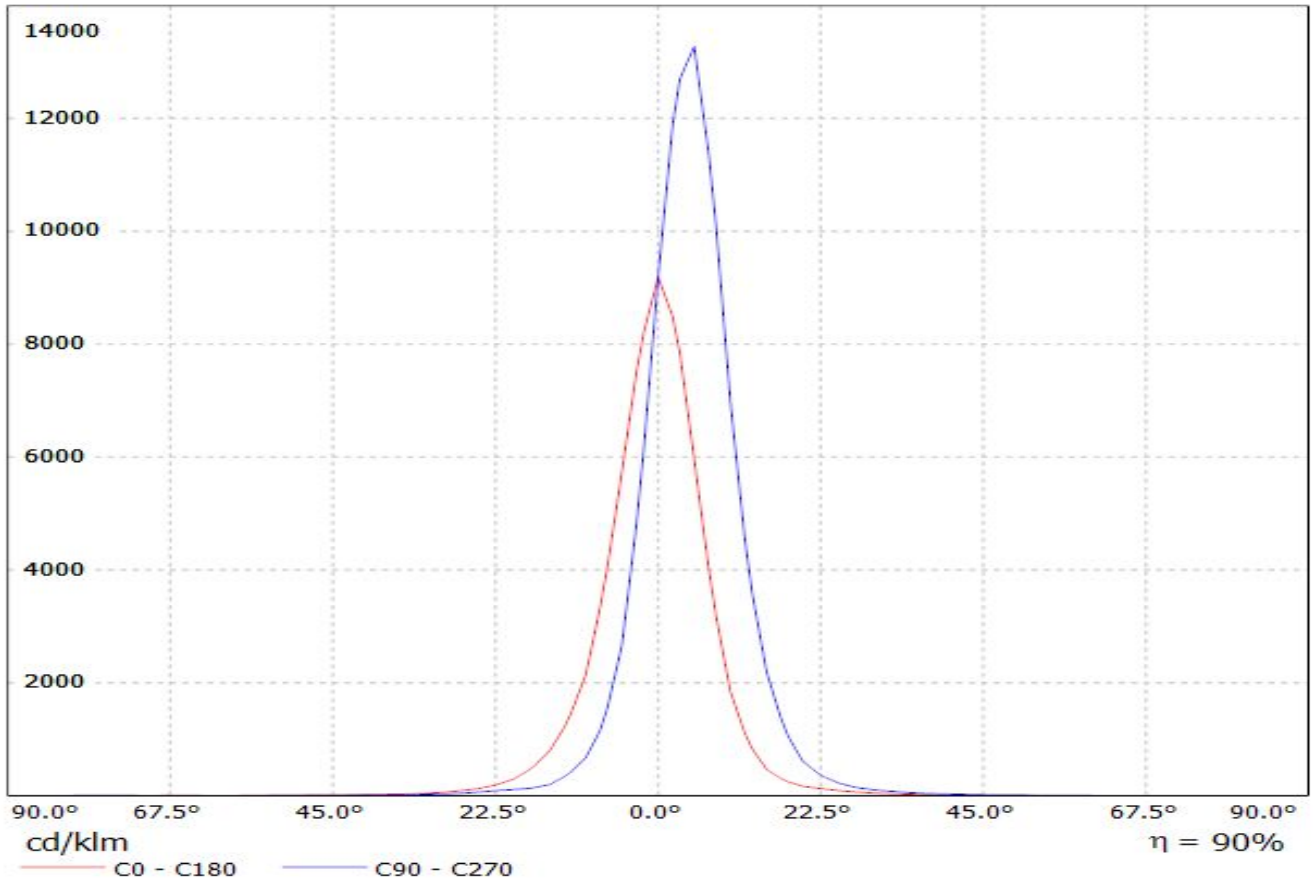

Luminaire: Ledil Oy CA13272_LAURA-O-WAS_(Rebel) Efficiency=87%
Lamps: 1 x Luxeon Rebel 80lm @ 250mA

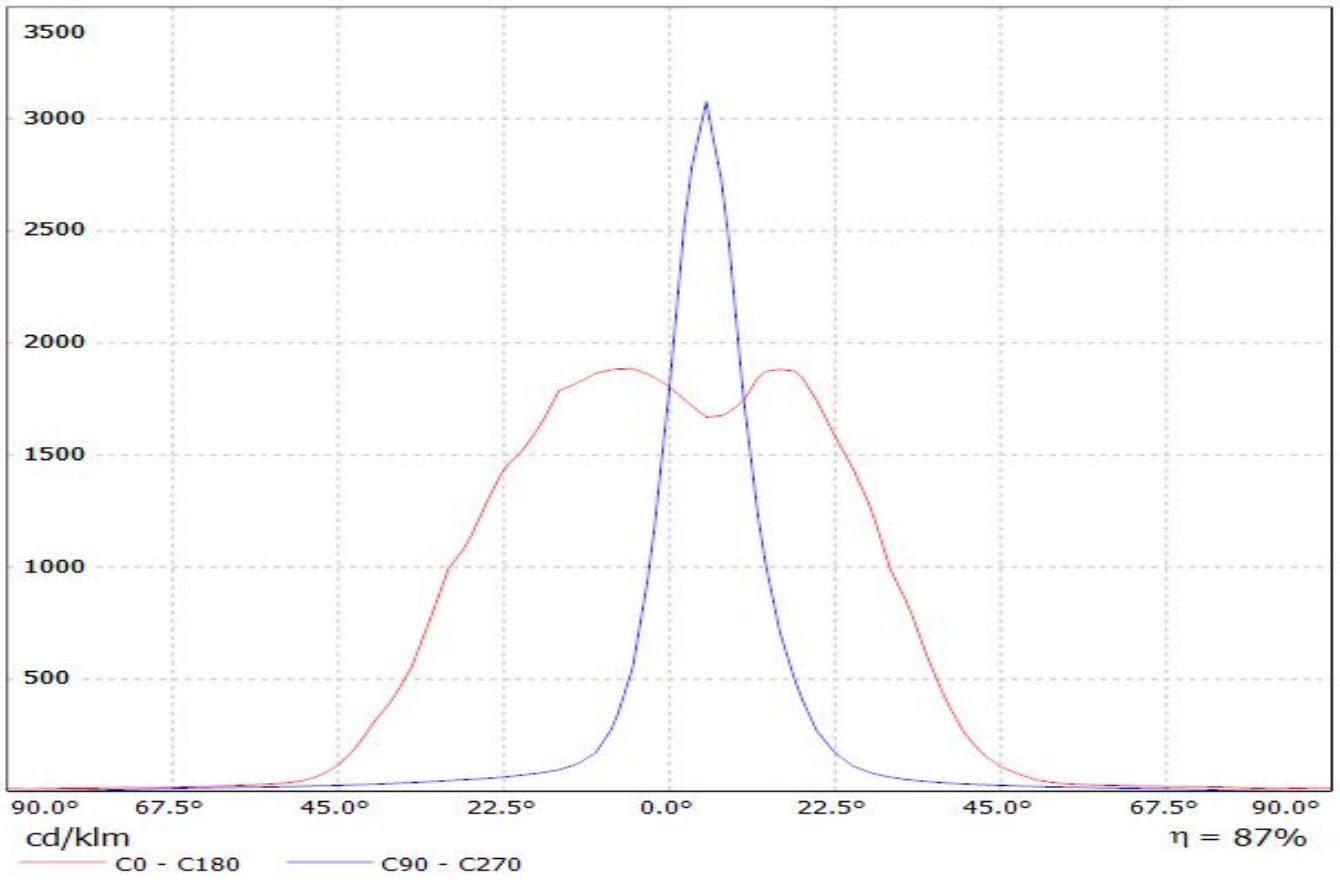

Luminaire: Ledil Oy CP13308_LAURA-O-WAS (Luxeon Rebel 80lm @ 250mA) Efficiency=87%
Lamps: 1 x Luxeon Rebel 80lm @ 250mA

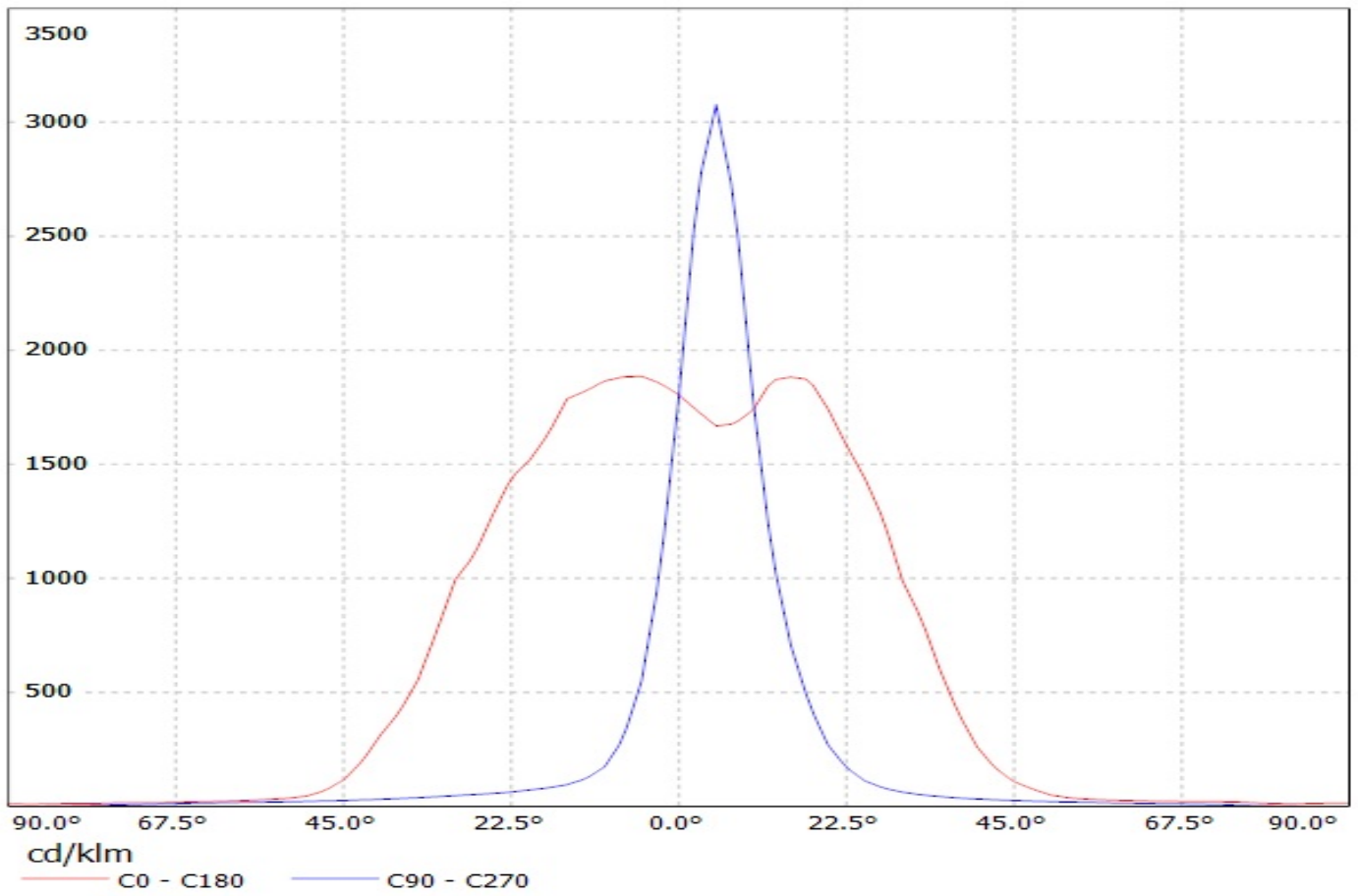

Luminaire: Ledil Oy CP13308_LAURA-O-WAS (Luxeon Rebel 80lm @ 250mA) Efficiency=87%
Lamps: 1 x Luxeon Rebel 80lm @ 250mA

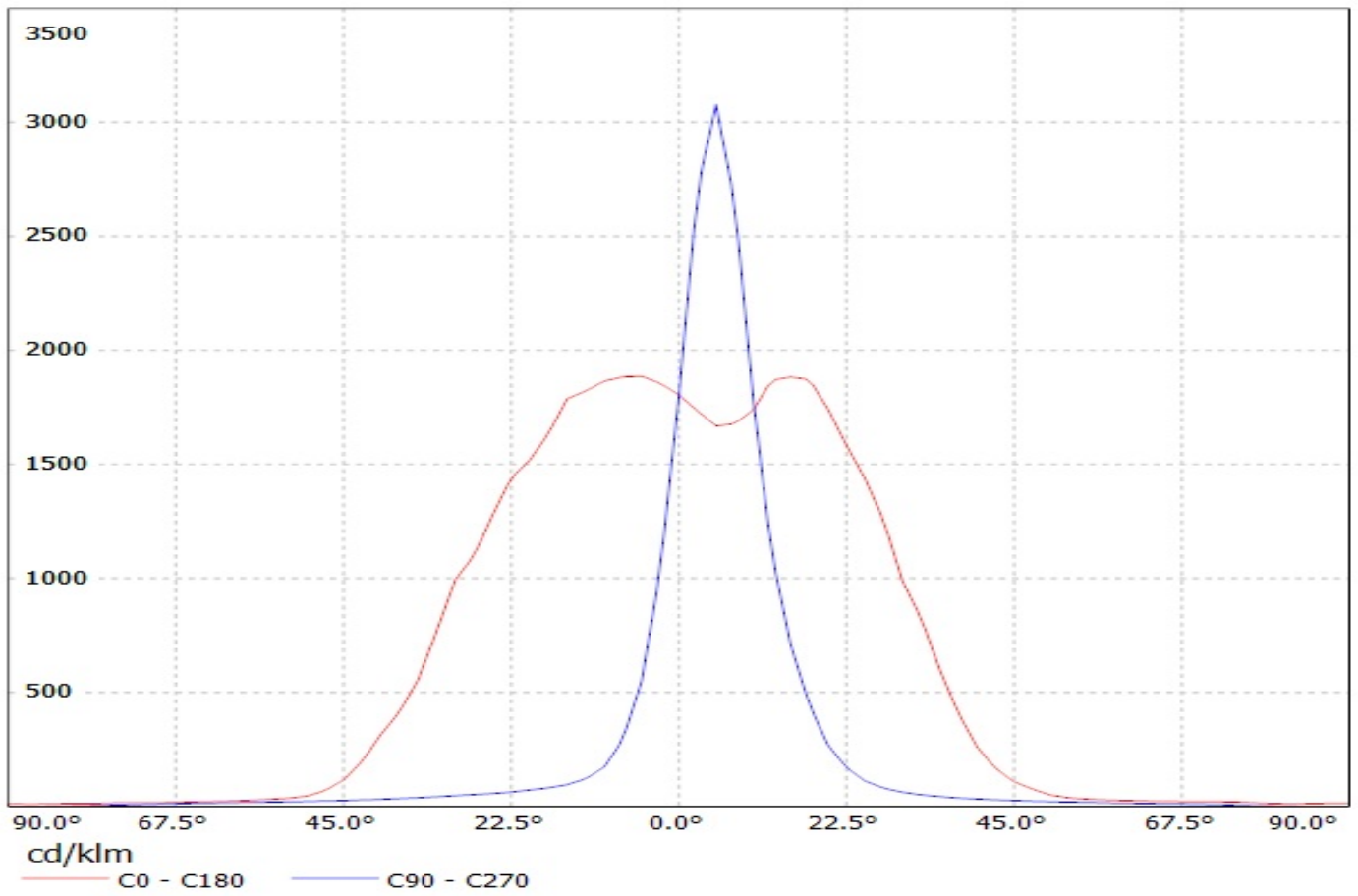

Luminaire: Ledil Oy CP13311_LAURA-SS-WAS (Luxeon Rebel 80lm @ 250mA) Efficiency=92%
Lamps: 1 x Luxeon Rebel 80lm @ 250mA

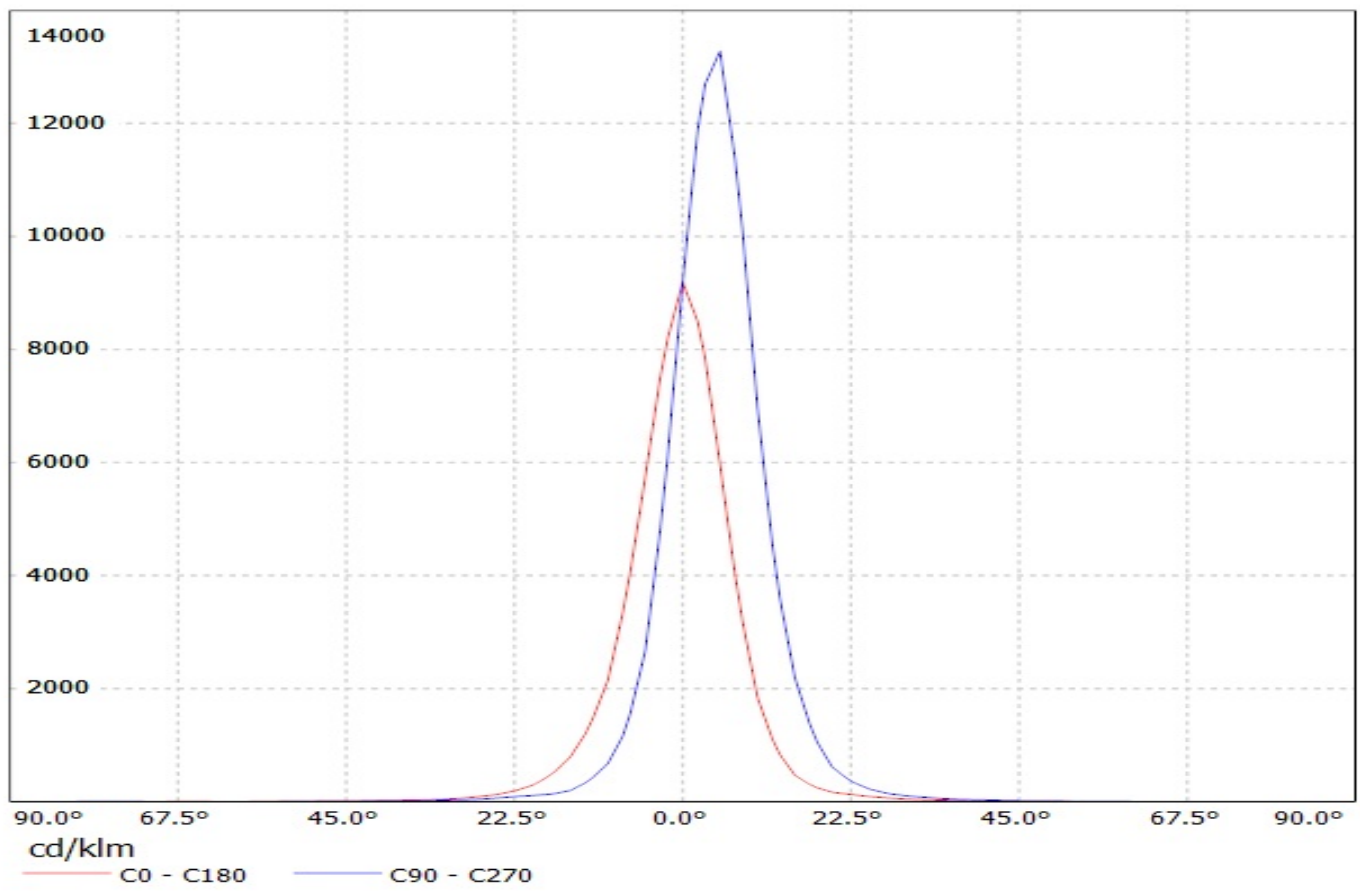

Luminaire: Ledil Oy CP13311_LAURA-SS-WAS (Luxeon Rebel 80lm @ 250mA) Efficiency=92%
Lamps: 1 x Luxeon Rebel 80lm @ 250mA

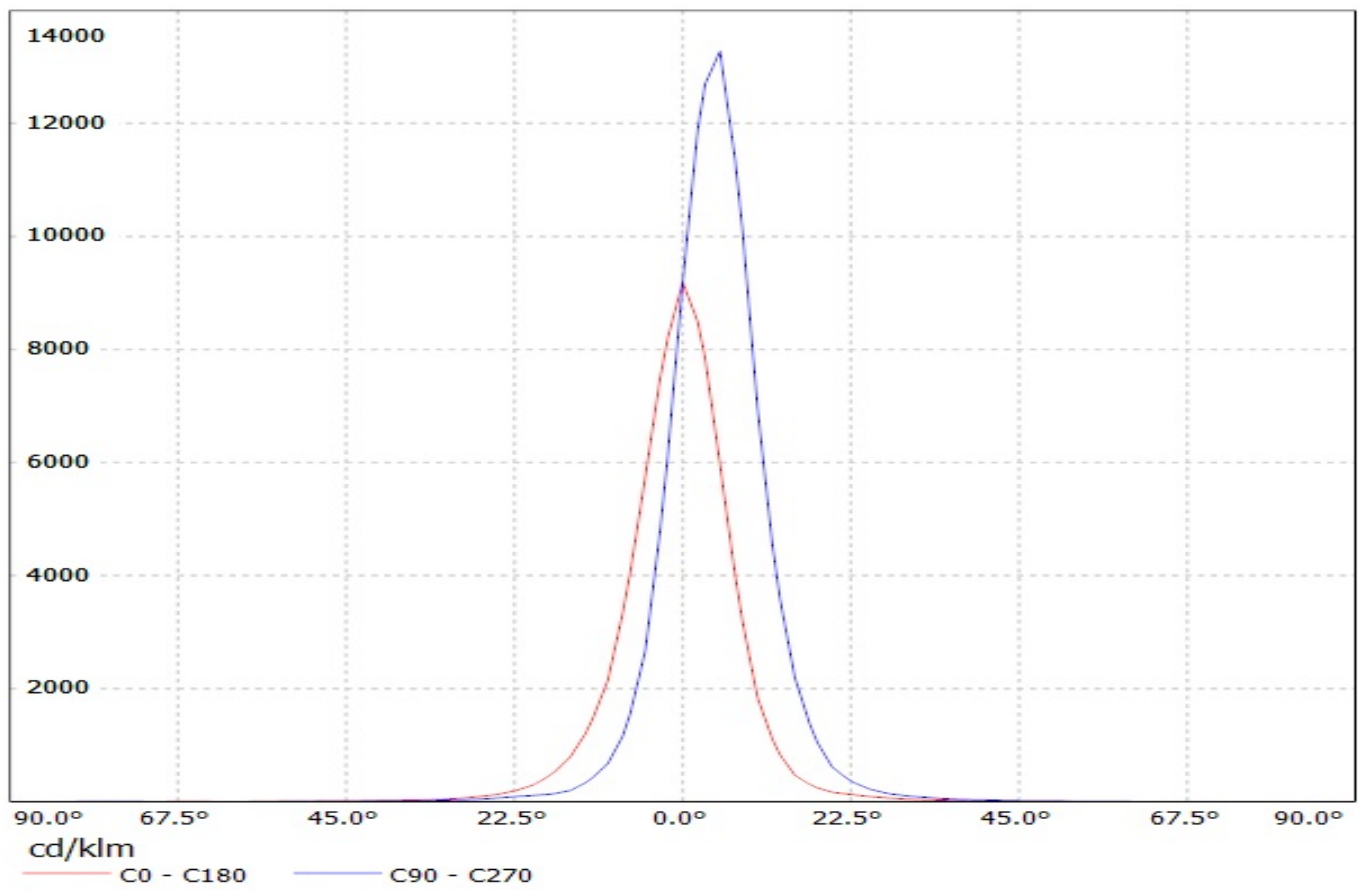

Luminaire: Ledil Oy CX11352_LAURA-RS-WHT CX11352_LAURA-RS-WHT (Luxeon Rebel) Efficiency=93%
Lamps: 1 x Luxeon Rebel (white) 87lm

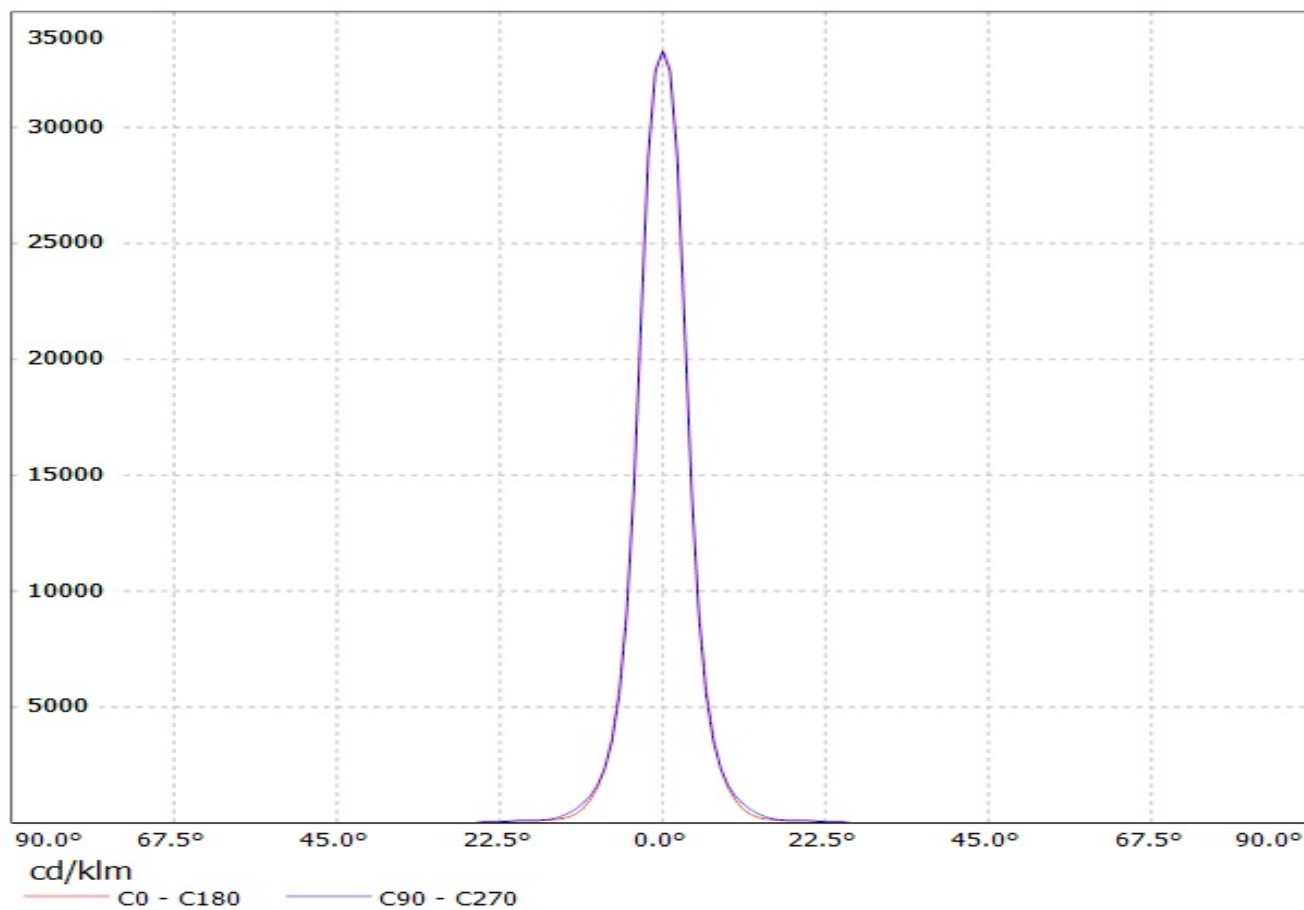

Luminaire: Ledil Oy CX12568_Laura-W (Luxeon Rebel 82lm @ 250mA) Efficiency=88%
Lamps: 1 x Luxeon Rebel 82lm @ 250mA

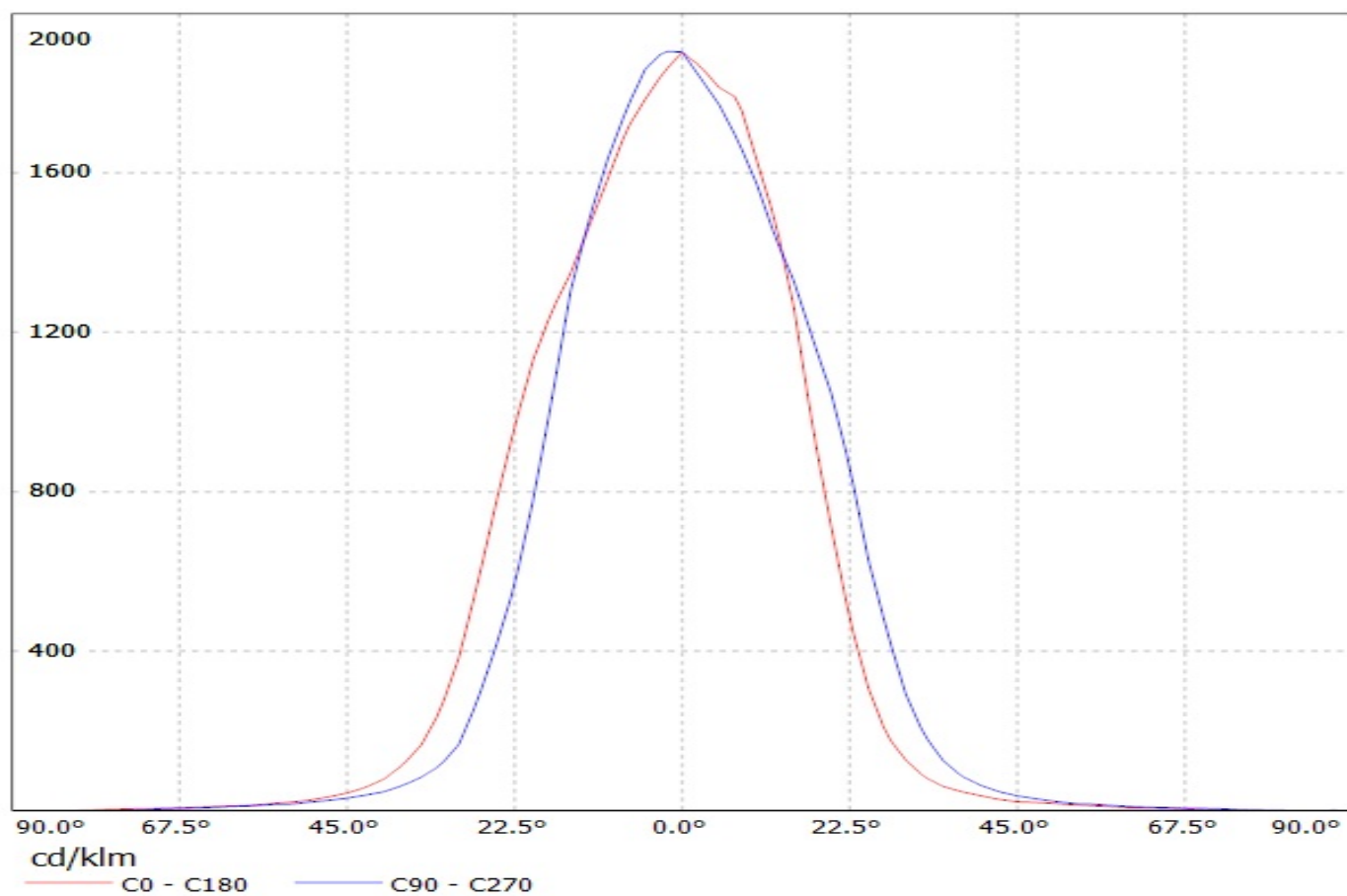

Luminaire: LEDiL CX11364 LAURA-O Eff.90%
Lamps: 1 x Luxeon Rebel (80lm@250mA)

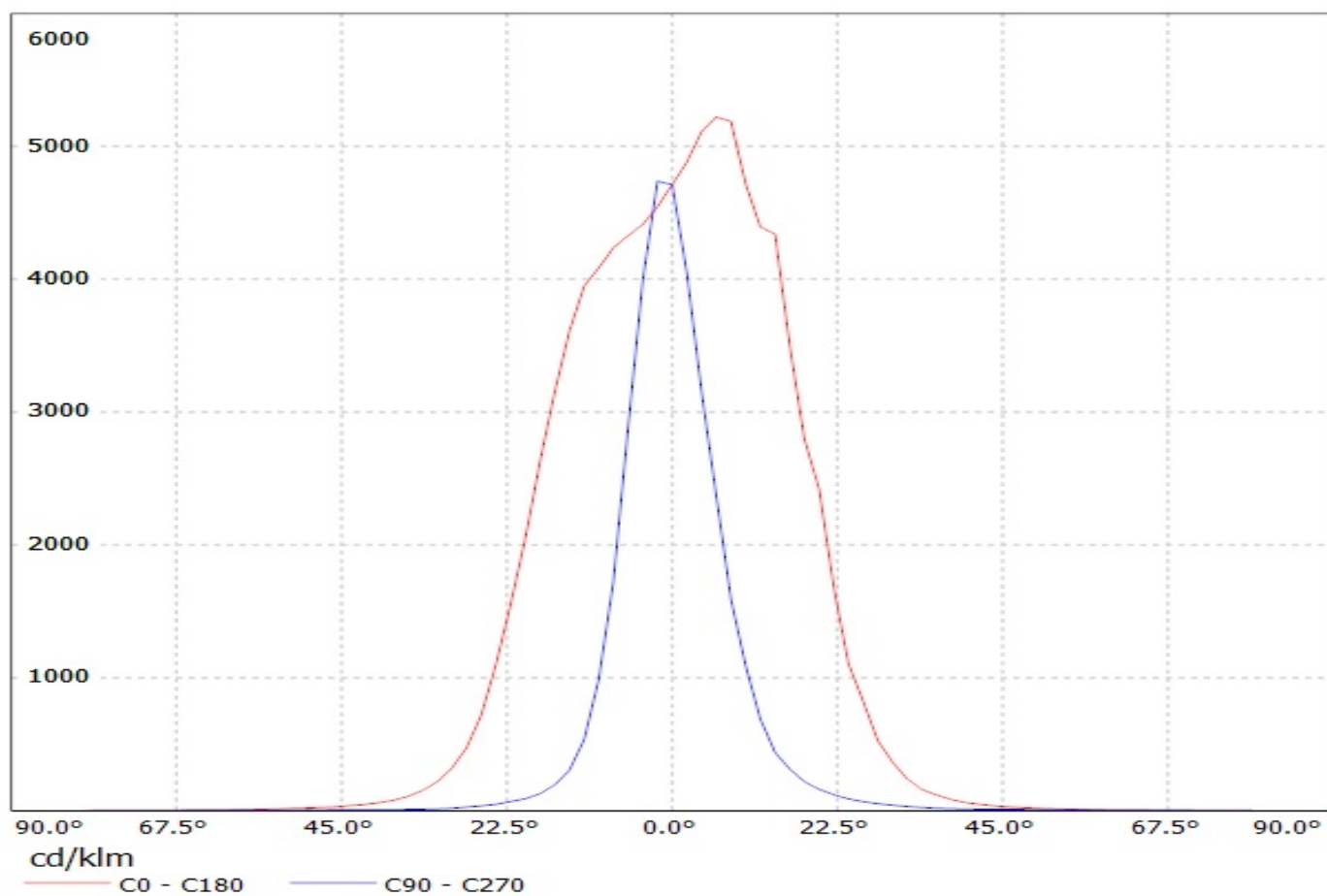

Luminaire: LEDiL OY CX11768_LAURA-WW

Lamps: 1 x Luxeon Rebel LXM8-PW30 61lm@250mA U: 2.86V P: 0.7W

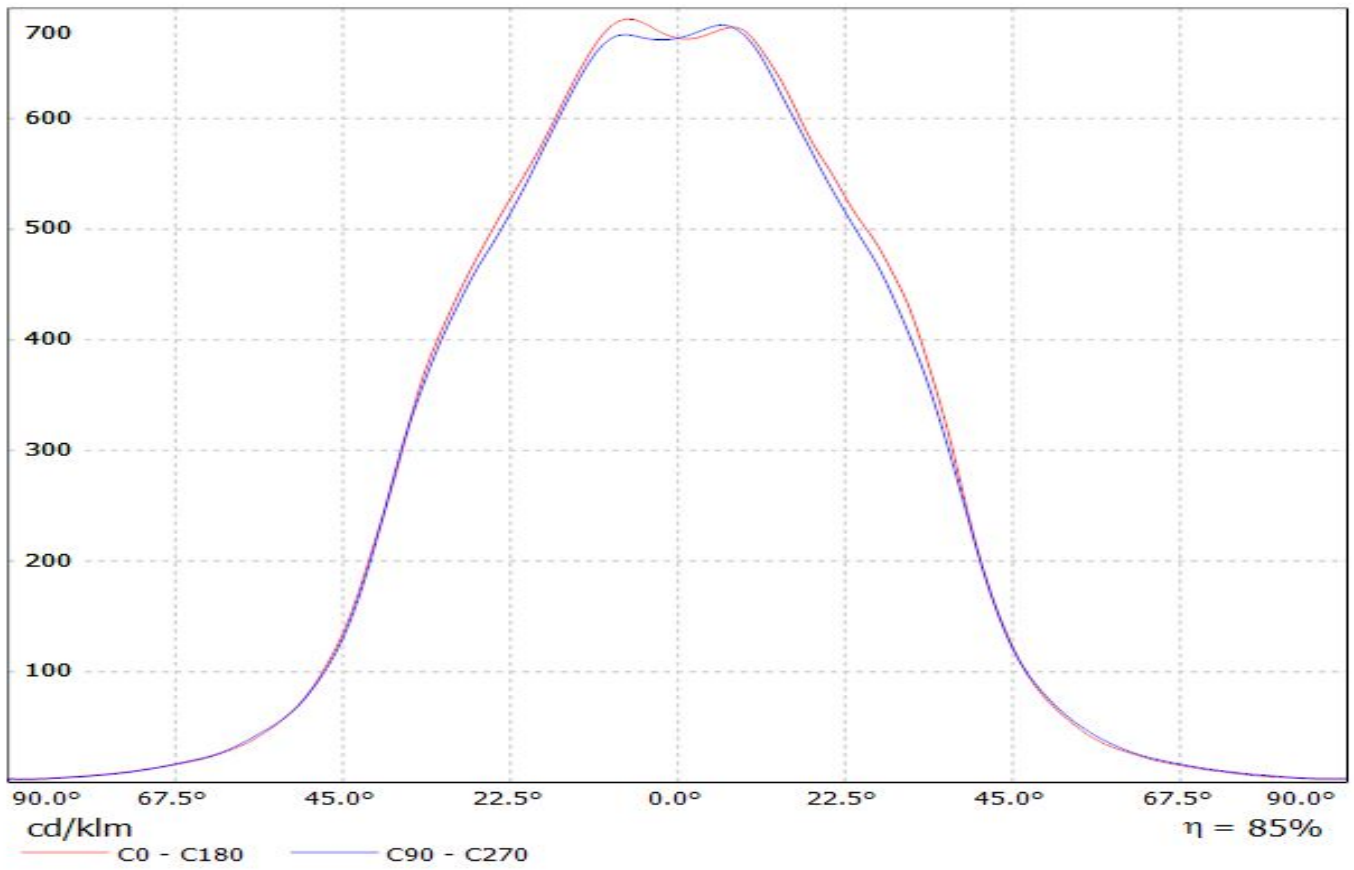

Luminaire: Ledil Oy CA13270_LAURA-SS-WAS_(Rebel) Efficiency=92%

Lamps: 1 x Luxeon Rebel 80lm @ 250mA

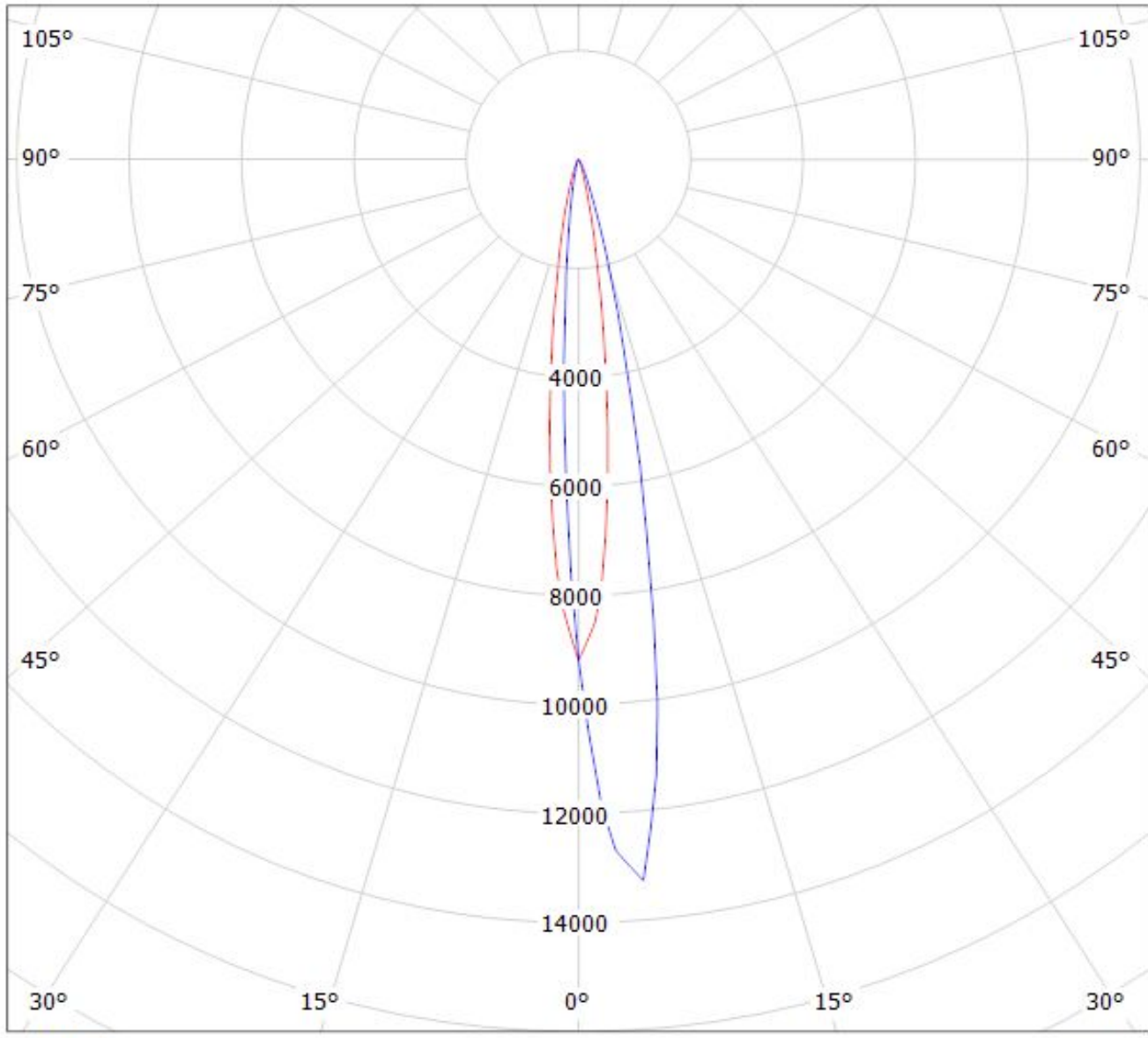

cd/klm

— C0 - C180 — C90 - C270

$\eta = 90\%$

Luminaire: Ledil Oy CA13272_LAURA-O-WAS_(Rebel) Efficiency=87%
Lamps: 1 x Luxeon Rebel 80lm @ 250mA

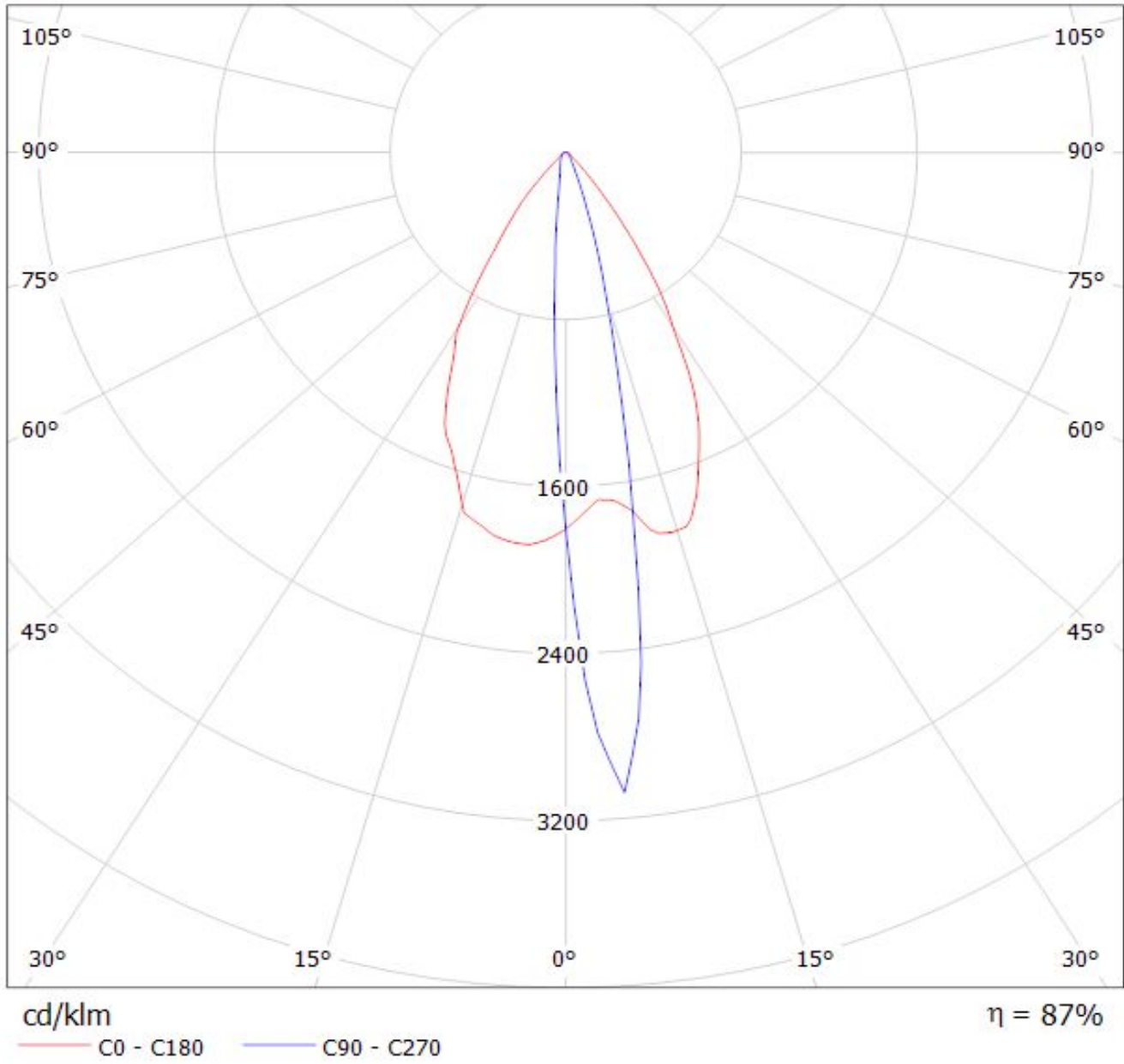

Luminaire: Ledil Oy CP13308_LAURA-O-WAS (Luxeon Rebel 80lm @ 250mA) Efficiency=87%
Lamps: 1 x Luxeon Rebel 80lm @ 250mA

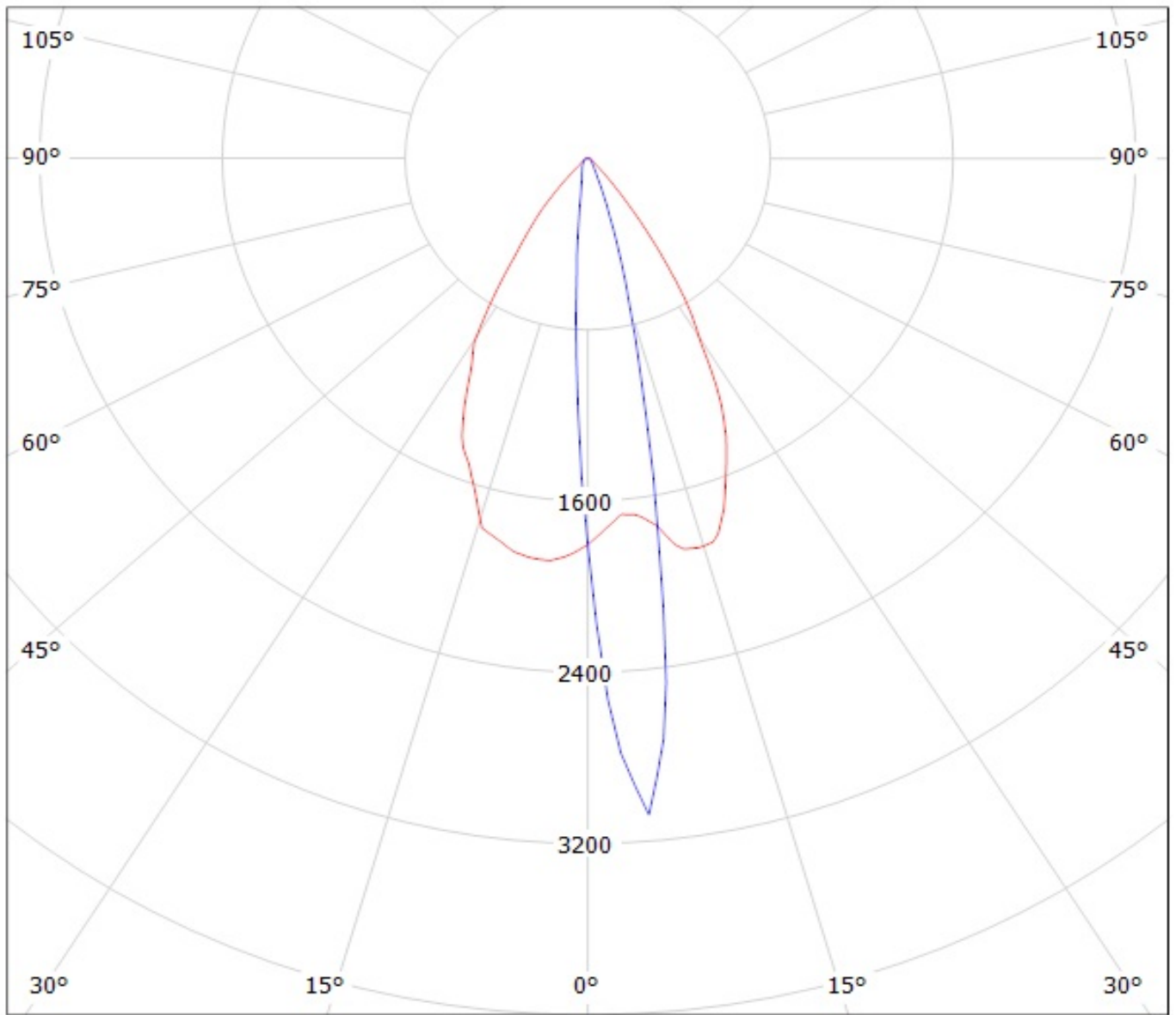

cd/klm
— C0 - C180 — C90 - C270

Luminaire: Ledil Oy CP13308_LAURA-O-WAS (Luxeon Rebel 80lm @ 250mA) Efficiency=87%
Lamps: 1 x Luxeon Rebel 80lm @ 250mA

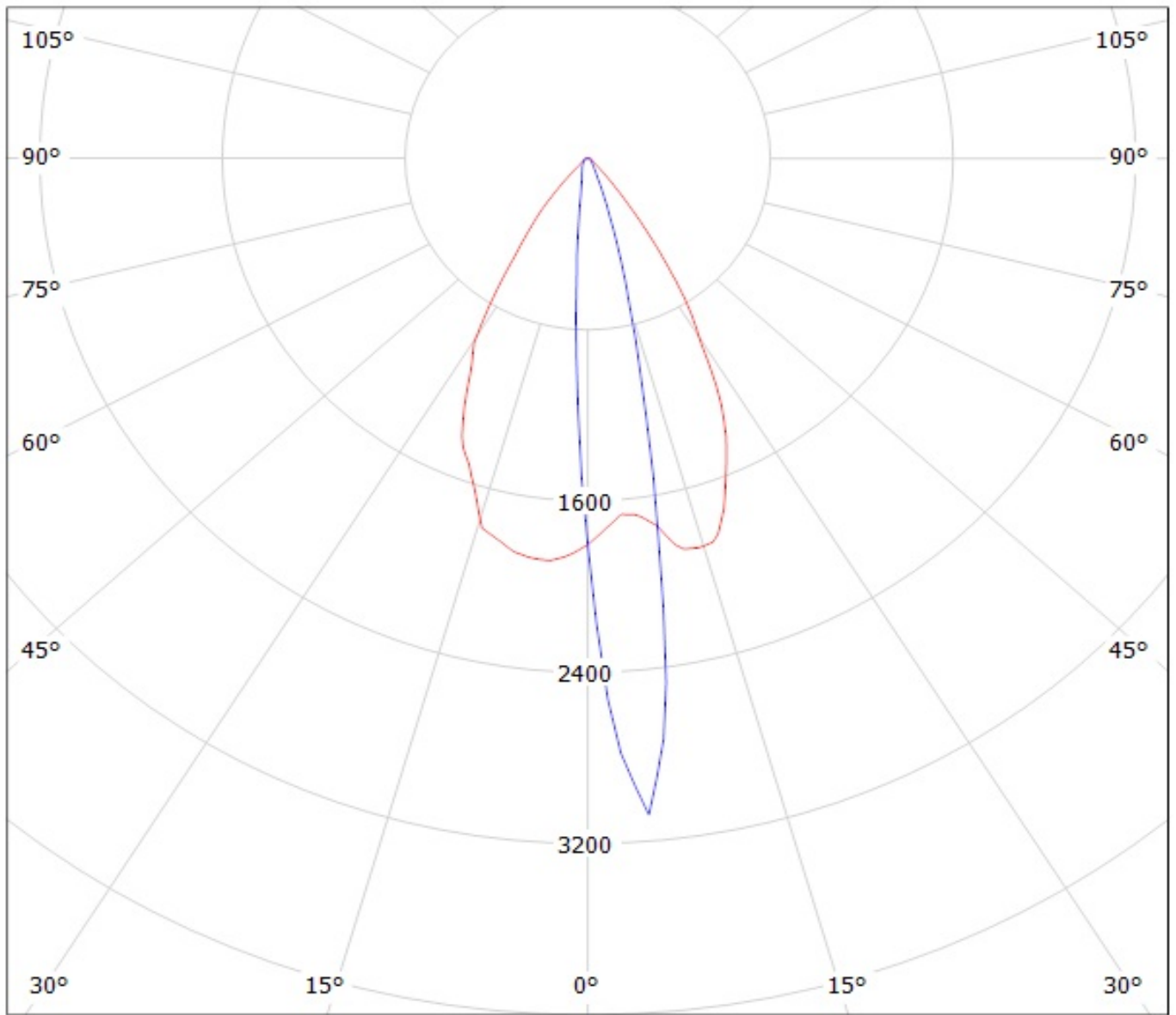

cd/klm
— C0 - C180 — C90 - C270

Luminaire: Ledil Oy CP13311_LAURA-SS-WAS (Luxeon Rebel 80lm @ 250mA) Efficiency=92%
Lamps: 1 x Luxeon Rebel 80lm @ 250mA

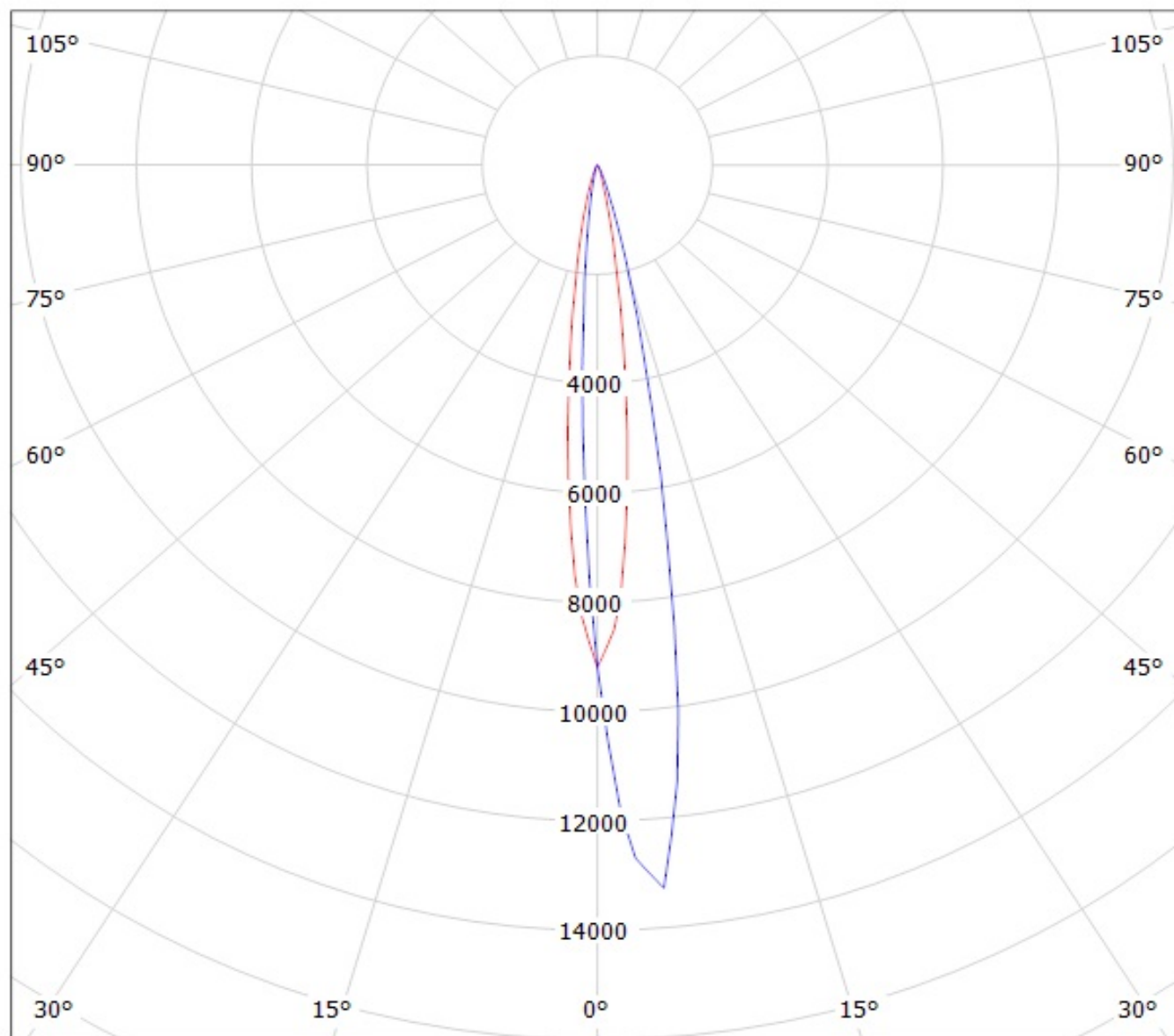

cd/klm

— C0 - C180

— C90 - C270

Luminaire: Ledil Oy CP13311_LAURA-SS-WAS (Luxeon Rebel 80lm @ 250mA) Efficiency=92%
Lamps: 1 x Luxeon Rebel 80lm @ 250mA

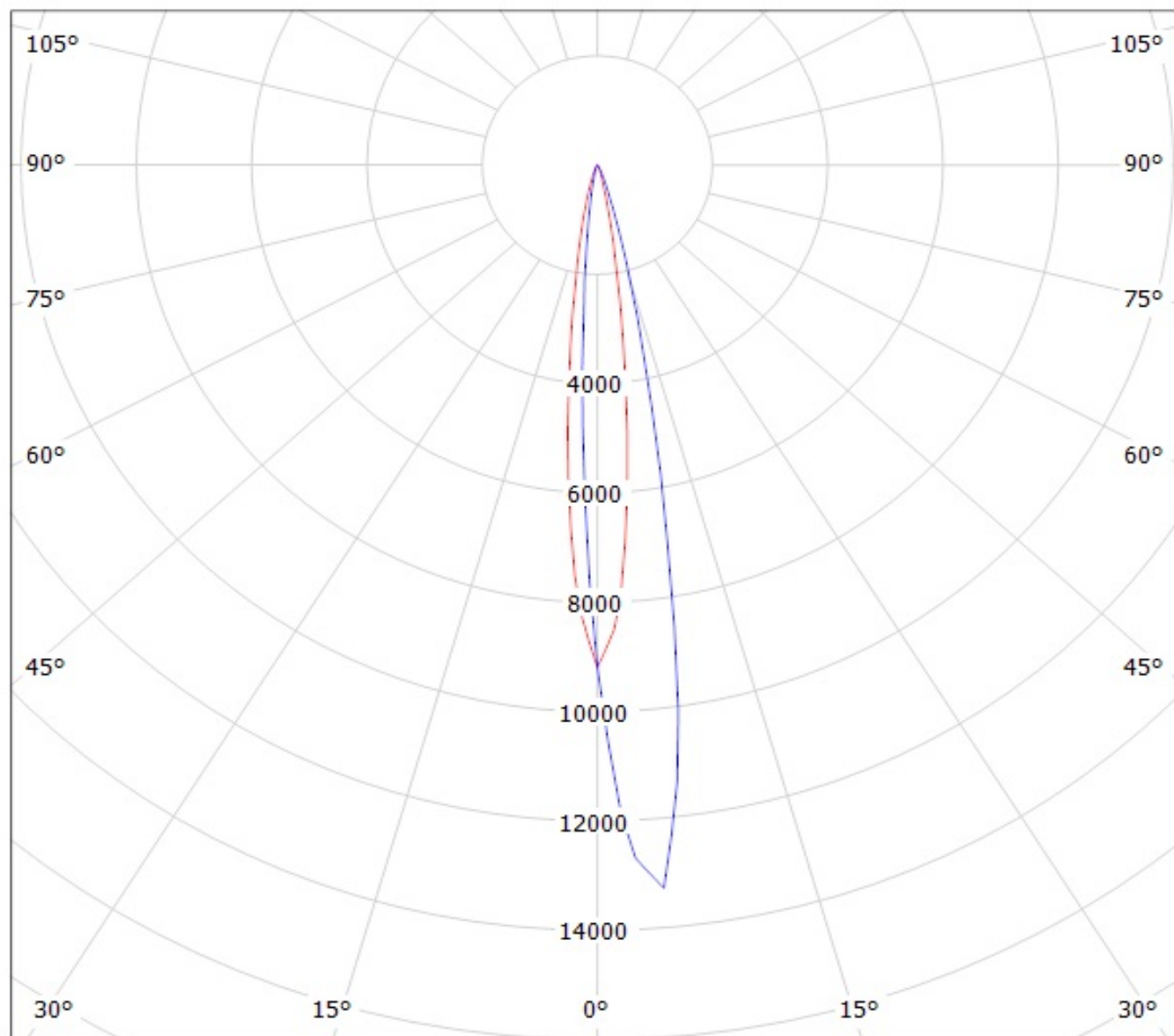

cd/klm

— C0 - C180

— C90 - C270

Luminaire: Ledil Oy CX11352_LAURA-RS-WHT CX11352_LAURA-RS-WHT (Luxeon Rebel) Efficiency=93%
Lamps: 1 x Luxeon Rebel (white) 87lm

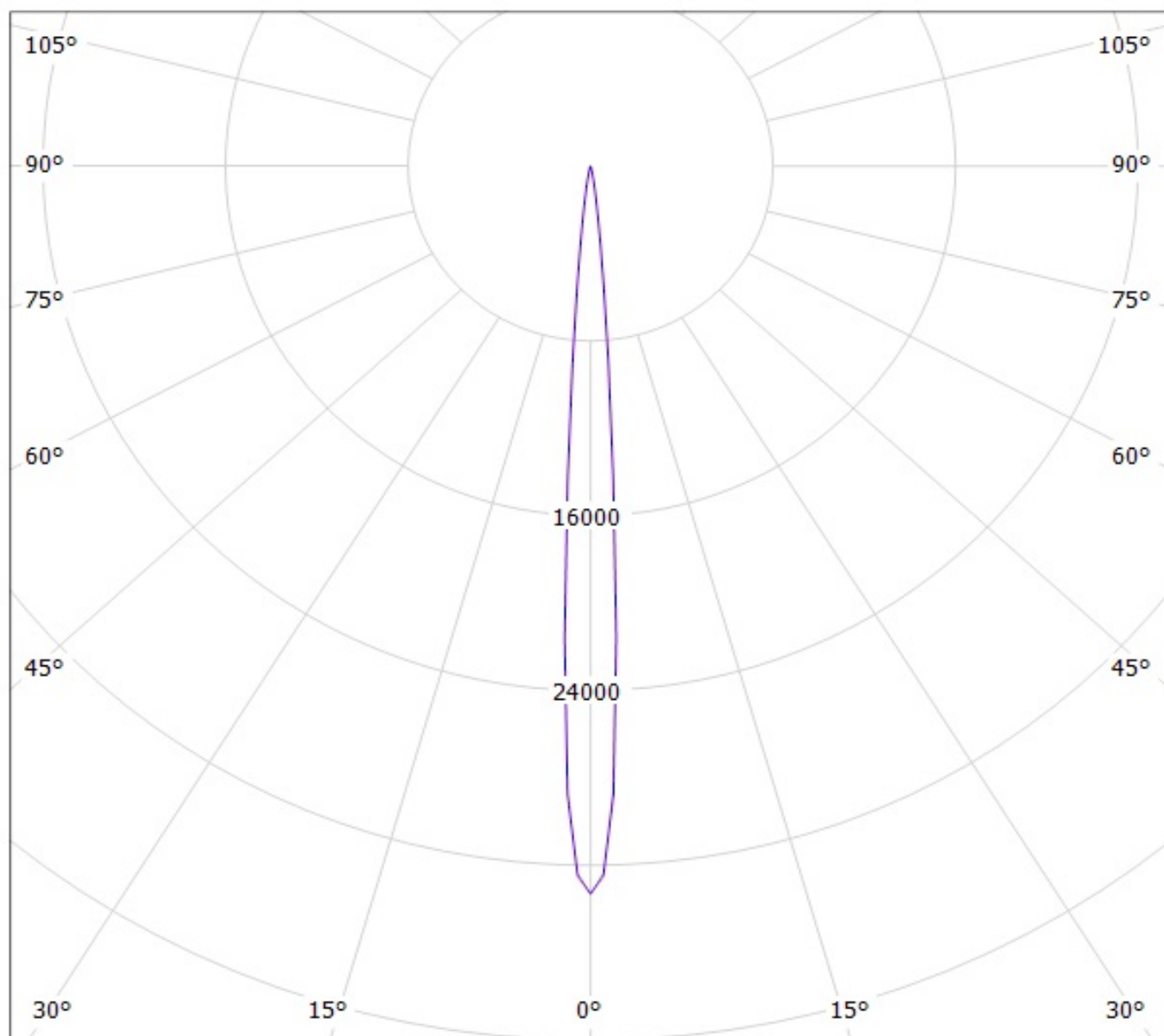

cd/klm

— C0 - C180

— C90 - C270

Luminaire: Ledil Oy CX12568_Laura-W (Luxeon Rebel 82lm @ 250mA) Efficiency=88%
Lamps: 1 x Luxeon Rebel 82lm @ 250mA

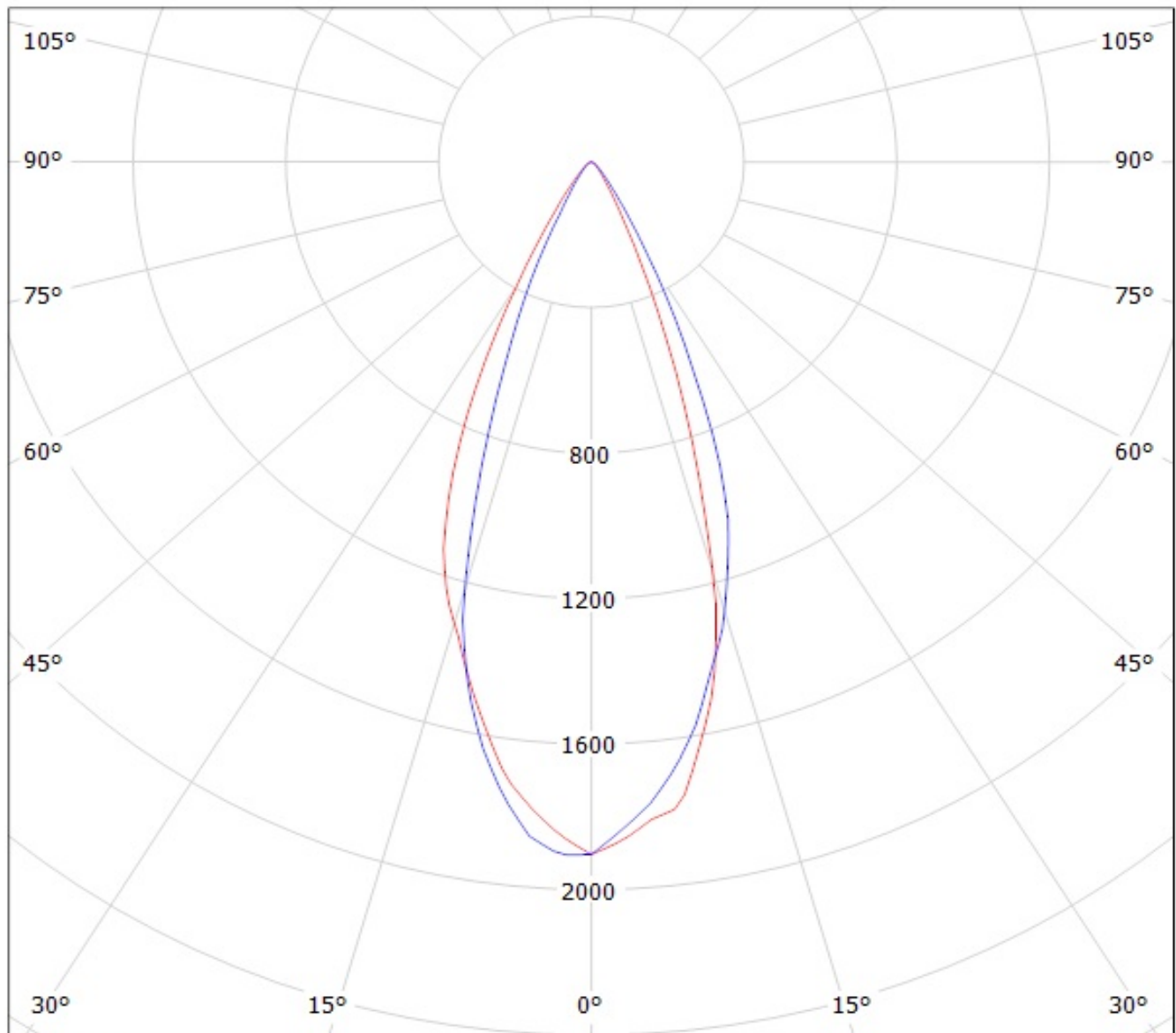

cd/klm

— C0 - C180

— C90 - C270

Luminaire: LEDiL CX11364_LAURA-O Eff.90%
Lamps: 1 x Luxeon Rebel (80lm@250mA)

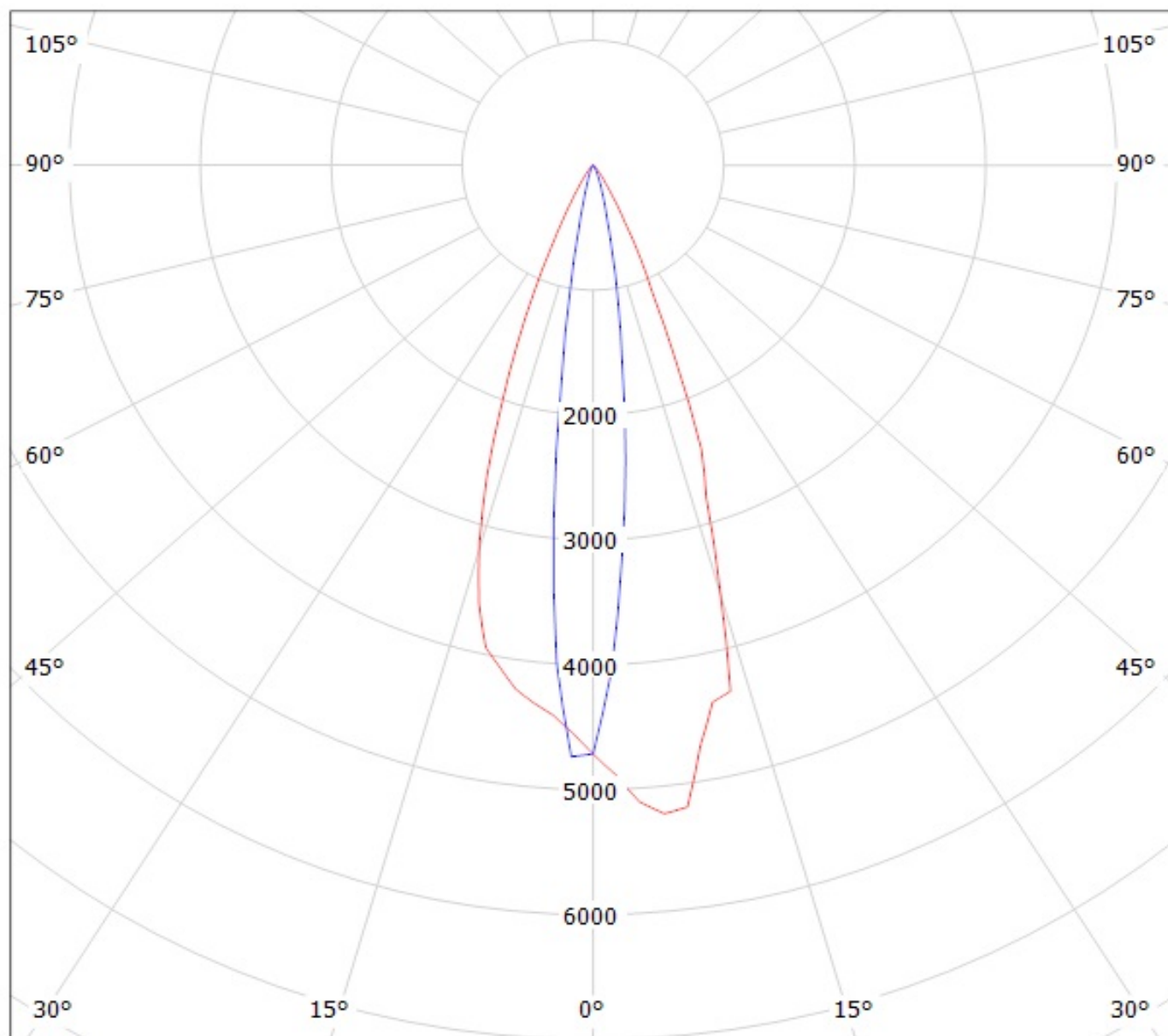

cd/klm

— C0 - C180

— C90 - C270

Luminaire: LEDiL OY CX11768_LAURA-WW

Lamps: 1 x Luxeon Rebel LXM8-PW30 61lm@250mA U: 2.86V P: 0.7W

