

DC-DC Converter DATA Sheet

MPDRX002S

1. Features

- Ultra high-speed response is realized by using original ripple detecting control.
- Up to 16A output current, non-isolated POL.
- Wide adjustable output voltage range by connecting external resistance (0.8V to 1.8V).
- Wide operating temperature (-40 °C to +85 °C).
- UVLO function, ON/OFF function, Output voltage sense function, Over-current function and, Over-temperature function are built in.

2. Appearance, Dimensions

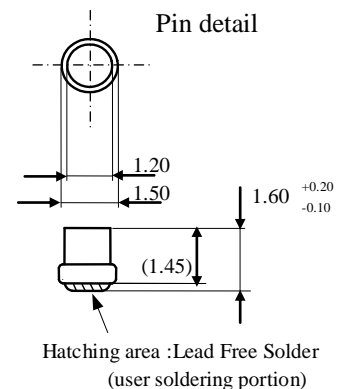
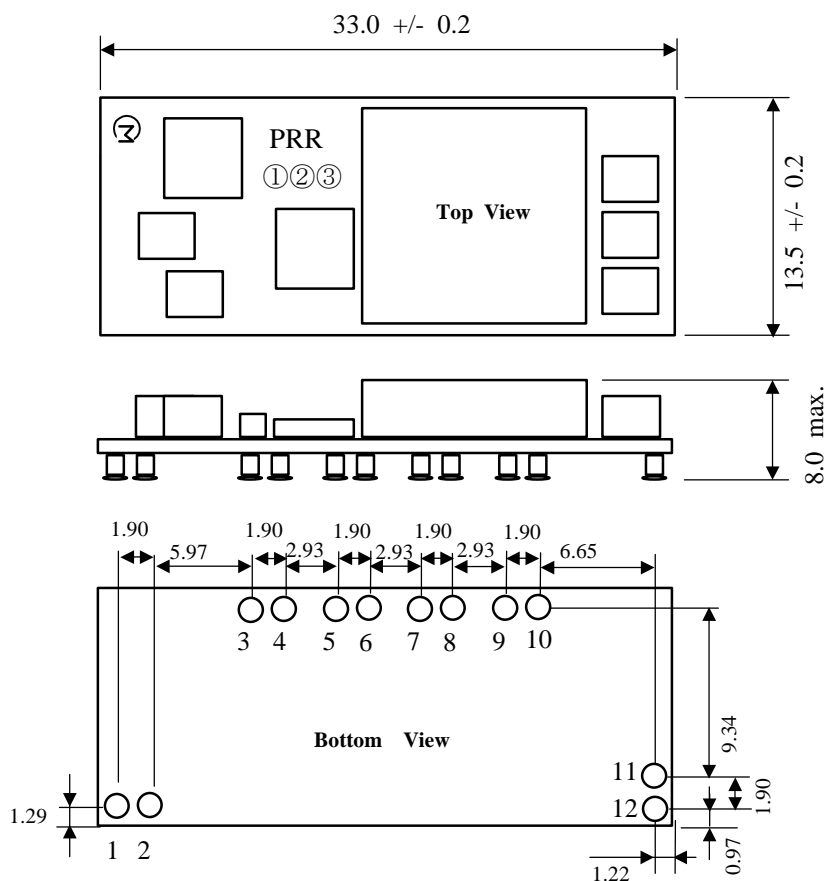
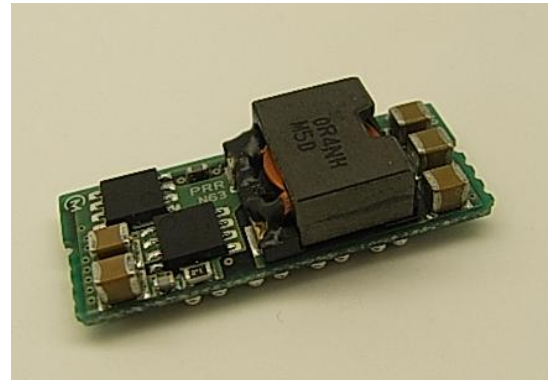

[unit : mm] Tolerance : 0.25mm

Marking

- (1) MFG ID/ Pin No.1 marking (M)
 (2) Part No. PRR
 (3) Lot No. (1)(2)(3)
 (1) Production factory Mark
 (2) Production Year
 (3) Production Month (1,2,3,...9,O,N,D)

Note:

1. This datasheet is downloaded from the website of Murata Manufacturing co., ltd. Therefore, it's specifications are subject to change or our products in it may be discontinued without advance notice. Please check with our sales representatives or product engineers before ordering.
2. This datasheet has only typical specifications because there is no space for detailed specifications. Therefore, please approve our product specifications or transact the approval sheet for product specifications before ordering.

Pin Number and Function

Pin No.	Symbol	Function
1,2	Vin	Input
3,4	GND	GND
5,6	Vout	Output
7,8	TRIM	Vout adjust control
9,10	SENSE	Vout sense input
11,12	ON/OFF	Remote ON/OFF

3. Block Diagram

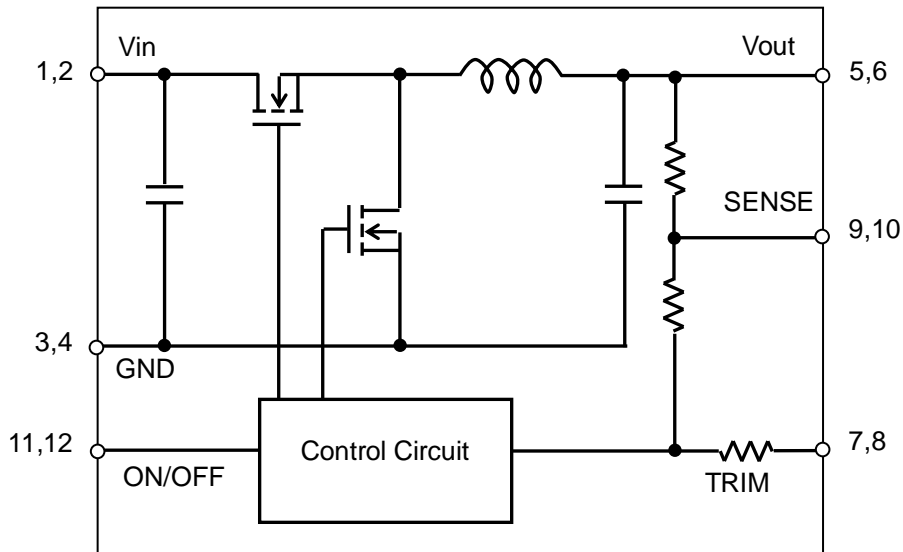

4. Environmental Conditions

- | | |
|---------------------------------|--|
| 4.1 Operating Temperature Range | -40 to +85 °C
(Temperature gradient $\leq 10^{\circ}\text{C}/\text{H}$) |
| 4.2 Storage Temperature Range | -40 to +85 °C
(Temperature gradient $\leq 25^{\circ}\text{C}/\text{H}$) |
| 4.3 Operating Humidity Range | 20% to 85% (No condensation) |
| 4.4 Storage Humidity Range | 10% to 90% (No condensation) |
| 4.5 Maximum Wet Bulb | 39°C |

5. Absolute Maximun Rating

- | | |
|------------------------------------|-------------------------------|
| 5.1 Input Voltage Range | 3.0V to 5.5V |
| 5.2 ON/OFF Pin Input Voltage Range | -0.3V to $V_{in}+0.3\text{V}$ |

 **Note:**

- This datasheet is downloaded from the website of Murata Manufacturing co., ltd. Therefore, it's specifications are subject to change or our products in it may be discontinued without advance notice. Please check with our sales representatives or product engineers before ordering.
- This datasheet has only typical specifications because there is no space for detailed specifications. Therefore, please approve our product specifications or transact the approval sheet for product specifications before ordering.

6. Characteristics

6. 1 Electrical Characteristics (Ta=25 °C)

Item	Symbol	Condition	Value			Unit	
			Min.	Typ.	Max.		
Input Voltage Range	Vin		3.0	3.3	5.5	V	
Rising UVLO Threshold	UVLOr	Vin Increasing	2.3	2.5	2.7	V	
Falling UVLO Threshold	UVLOf	Vin Decreasing	2.1	2.4	2.65	V	
Output Voltage Adjustable Range	Vout		0.8	-	1.8	V	
Output Voltage Tolerance	Vo tol	Over Vin, Io, Temperature Range Rset=0.5% tolerance	-2.5	-	+2.5	%Vo	
Output Current	Iout	See the thermal derating curve in section 6.2.	0	-	16	A	
Ripple Voltage	Vrpl	Vin =3.3V, Iout=16A BW=20MHz, Cout=100µF	Vout=1.8V	-	15	40	mV(p_p)
			Vout=0.8V	-	25	50	
Transient Response	Ttr	Vin=3.3V, Vout=1.8V Iout=8↔16A, di/dt=2A/µs, Cout=100µF	Recovery Time	-	20	-	µsec
	Δ Vtr		Vout Deviation	-	50	-	mV
Efficiency	EFF	Vin =3.3V, Vout=1.8V, Iout=16A	-	90	-	%	
Operating Frequency	Frq	Vin =3.3V, Vout=1.8V	-	450	-	kHz	
		Vin =3.3V, Vout=0.8V	-	350	-		
ON/OFF pin High Voltage	VIH	ON/OFF pin is pulled up to Vin inside of the DC-DC Converter. If ON/OFF pin is left open, the DC-DC Converter shall be "ON". This pin will be pulled down to GND inside the DC-DC Converter when OCP or OTP events occur. Please do NOT connect this pin to Vin with low impedance line, so as not to damage the converter..					
ON/OFF pin Low Voltage	VIL	If ON/OFF pin is connected to GND, the DC-DC Converter shall be "OFF".	0	-	0.7	V	
Short Circuit Protection	SCP	Vin=3.3V, Reset, Followed by Auto-Recovery	17	27	-	A	
Over Temperature Protection	OTP	Reset, Followed by Auto-Recovery	-	115	-	°C	
External Output Capacitor	Cout	When input voltage is ideal voltage source	47	100	1000	µF	
Rising Overshoot	Vover		-	0	+10	%	
Output Delay	Td	Output Voltage 0-10% (remote on)	0.2	0.5	2	msec	
Output Rise Time	Tr	Output Voltage 10-90%	1	4	8	msec	

⚠ Note:

1. This datasheet is downloaded from the website of Murata Manufacturing co., ltd. Therefore, it's specifications are subject to change or our products in it may be discontinued without advance notice. Please check with our sales representatives or product engineers before ordering.
2. This datasheet has only typical specifications because there is no space for detailed specifications. Therefore, please approve our product specifications or transact the approval sheet for product specifications before ordering.

6. 2 Thermal Derating

MPDRX002S Thermal Derating
[Vin=3.3V , Vout=1.8V]

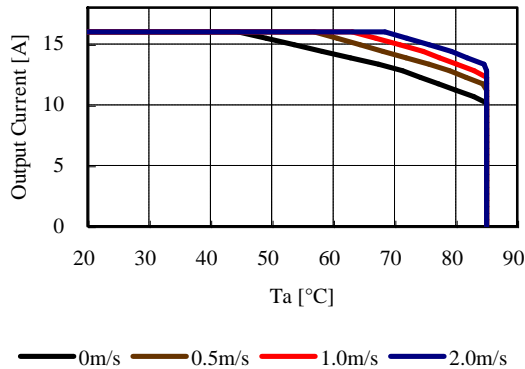

MPDRX002S Thermal Derating
[Vin=5V , Vout=1.8V]

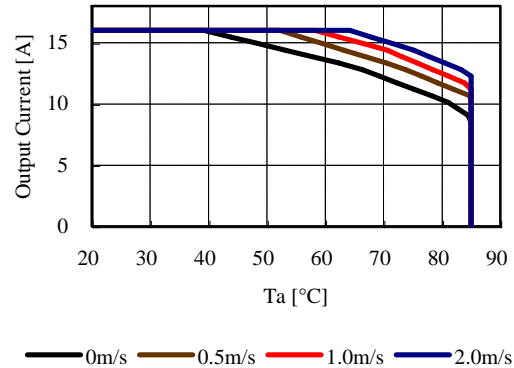

The above derating limits apply to this product soldered directly to 101.6*180mm*1.6mm PCB (double-sided, with 70um copper). Any adjacent parts of high temperature may cause overheating. For reliable operation, please ensure that the FET temperature of this product is maintained below 120°C and the inductor temperature is below 106°C.

7. Operation information

7. 1 Adjusting the Output Voltage

The output voltage can be adjusted from 0.8V to 1.8V by connecting a resistor between TRIM-pin(7,8Pin) to GND-pin(3,4Pin).

The following equation gives the required external-resistance value to adjust the output voltage to the required Vout.

Internal circuit

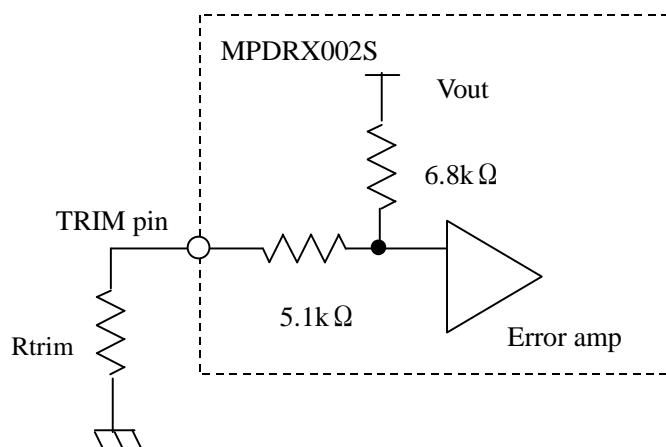

$$R_{trim} = \frac{5440}{V_{out} - 0.8} - 5100 \quad [\text{ohm}]$$

⚠ Note:

1. This datasheet is downloaded from the website of Murata Manufacturing co., ltd. Therefore, it's specifications are subject to change or our products in it may be discontinued without advance notice. Please check with our sales representatives or product engineers before ordering.
2. This datasheet has only typical specifications because there is no space for detailed specifications. Therefore, please approve our product specifications or transact the approval sheet for product specifications before ordering.

<Rtrim calculation example>

Vout [V]	Calculated Rtrim [ohm]	Rtrim example [ohm]
1.8	340	330
1.5	2671	2.4k+270
1.2	8500	8.2k+300
1.0	22100	22k+100
0.8	∞	Open

7. 2 ON/OFF Control

ON/OFF function

By using ON/OFF function, the operation of this product can be disabled without disconnection of input voltage. Sequence of a power supply system and power-saving control can be easily achieved using this function.

ON/OFF Control Operation

When ON/OFF-pins(11,12pin) are left open

..... Output Voltage =ON

When ON/OFF-pins(11,12pin) are connected to GND

..... Output Voltage=OFF

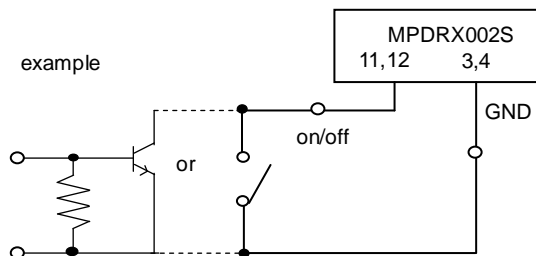

7. 3 Output voltage sensing

By connecting SENSE-pin to the load, output voltage drop in wiring shall be compensated.

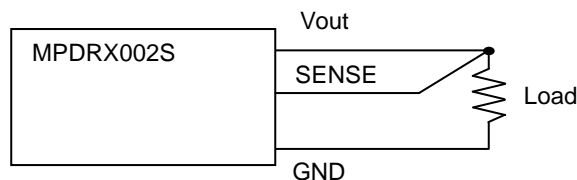

Please do NOT connect SENSE-pin to the output of LC filter that is set to the Vout line. When using this way, this product will not operate properly.

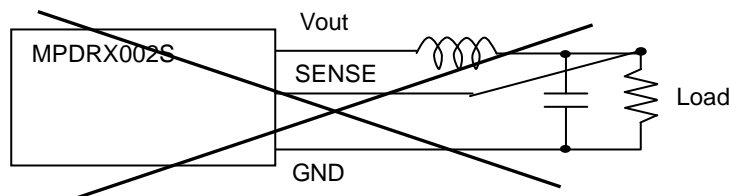

⚠ Note:

1. This datasheet is downloaded from the website of Murata Manufacturing co., ltd. Therefore, it's specifications are subject to change or our products in it may be discontinued without advance notice. Please check with our sales representatives or product engineers before ordering.
2. This datasheet has only typical specifications because there is no space for detailed specifications. Therefore, please approve our product specifications or transact the approval sheet for product specifications before ordering.

7.4 Input External capacitor

It is recommended to connect a low-impedance electrolytic capacitor of 100 μ F or more at Vin terminal. Smaller input capacitor may lead to an unstable operation of this product caused by input voltage fluctuation. Please check the proper operation of it on your product when smaller input capacitor is used.

Using ceramic capacitors as input capacitor may cause an increase of output voltage, because input ripple current flows through the external input capacitor and wiring resistance.

This phenomenon is affected by the position of external capacitors, the value of external capacitors and voltage difference between Vin and Vout. Using low-impedance electrolytic capacitor will ease this problem. Please check the proper operation of it on your product when ceramic input capacitor is used.

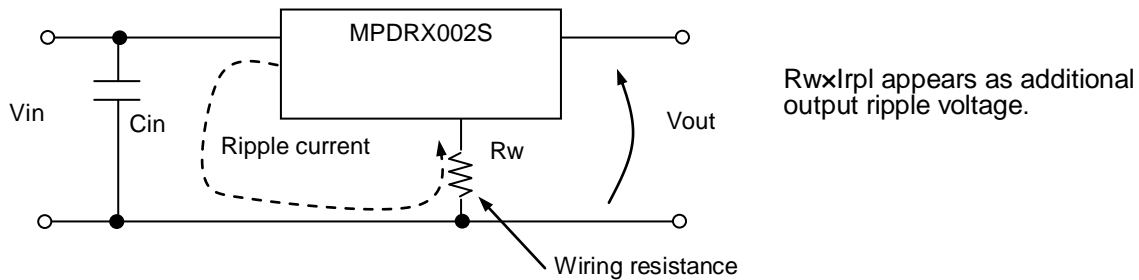

7.5 Output External capacitor

Ceramic capacitors are recommended as output external capacitor. Using ceramic capacitors, small output variation and small ripple voltage are realized.

Output capacitor should be within 47 μ F to 1000 μ F. Output capacitor shall be placed near the output terminal. When using plural capacitors, please make sure to place a capacitor of at least 47 μ F near the output terminal, and place other capacitors near the load.

When using LC output filter, please make sure to place a capacitor of at least 47 μ F near the output terminal.

8. Reliability

8.1 Humidity

According to JIS-C-0022.

40 \pm 2 $^{\circ}$ C, 90 to 95%RH, 100 hours. Leave for 4 hours at room temperature.

No damage in appearance and no deviation from electrical characteristics (section 6. 1).

8.2 Temperature Cycles

Repeat cycle 5 times. Leave 2 hours at room temp.

No damage in appearance and no deviation from electrical characteristics (section 6. 1).

Step	Condition	Time
1	-40 $^{\circ}$ C \pm 3 $^{\circ}$ C	30 minutes
2	Room Temp	5-10 minutes
3	+85 $^{\circ}$ C \pm 2 $^{\circ}$ C	30 minutes
4	Room Temp.	5-10 minutes

8.3 Vibration

10 to 55Hz, 1.5mm amplitude (1minute cycle), 1 hour for each of X, Y, Z directions.

No damage in appearance and no deviation from electrical characteristics (section 6. 1).

8.4 Mechanical Shock

20G, 1 time for each X, Y, Z directions.

No damage in appearance and no deviation from electrical characteristics (section 6. 1).

Note:

- This datasheet is downloaded from the website of Murata Manufacturing co., ltd. Therefore, it's specifications are subject to change or our products in it may be discontinued without advance notice. Please check with our sales representatives or product engineers before ordering.
- This datasheet has only typical specifications because there is no space for detailed specifications. Therefore, please approve our product specifications or transact the approval sheet for product specifications before ordering.

9. Test Circuit

Using the following test circuit, the initial values under section 6.1 shall be met.

9.1. General Measure Circuit

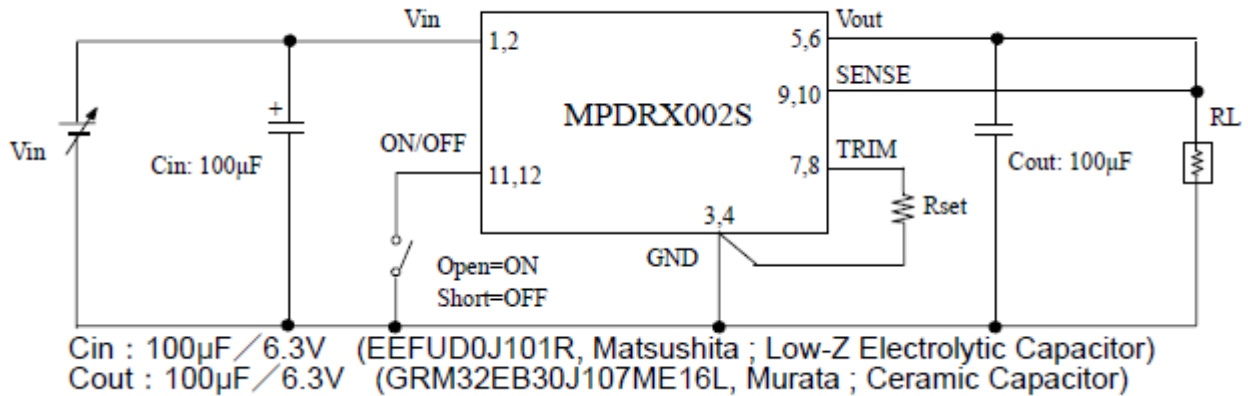

9.2. Ripple Noise Measurement Circuit

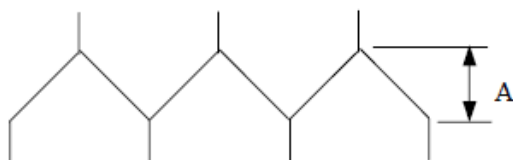
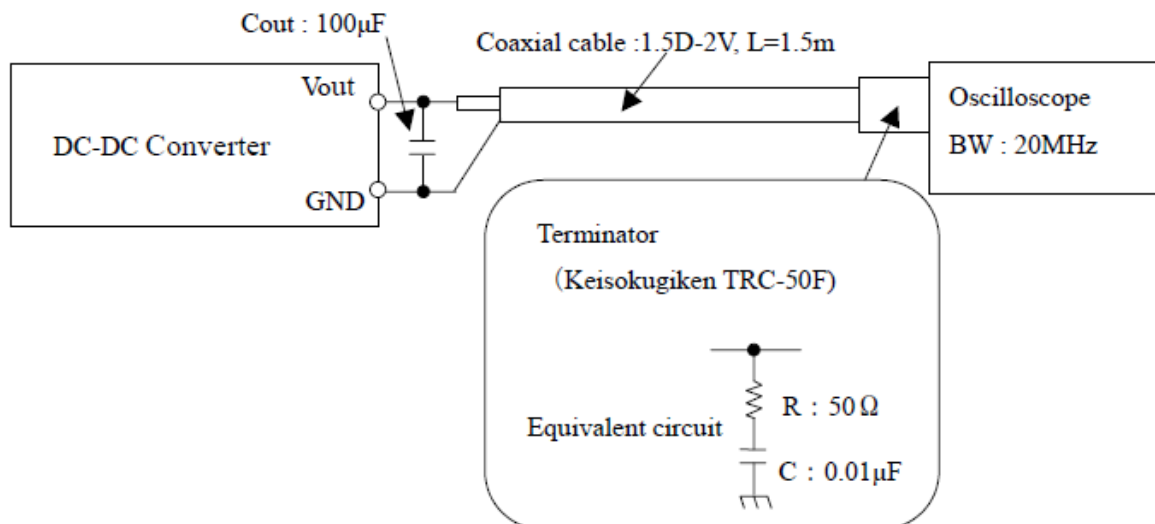

A : Output Ripple Voltage

⚠ Note:

1. This datasheet is downloaded from the website of Murata Manufacturing co., ltd. Therefore, it's specifications are subject to change or our products in it may be discontinued without advance notice. Please check with our sales representatives or product engineers before ordering.
2. This datasheet has only typical specifications because there is no space for detailed specifications. Therefore, please approve our product specifications or transact the approval sheet for product specifications before ordering.

10. Packaging Specification

10.1. Emboss Tape Dimensions

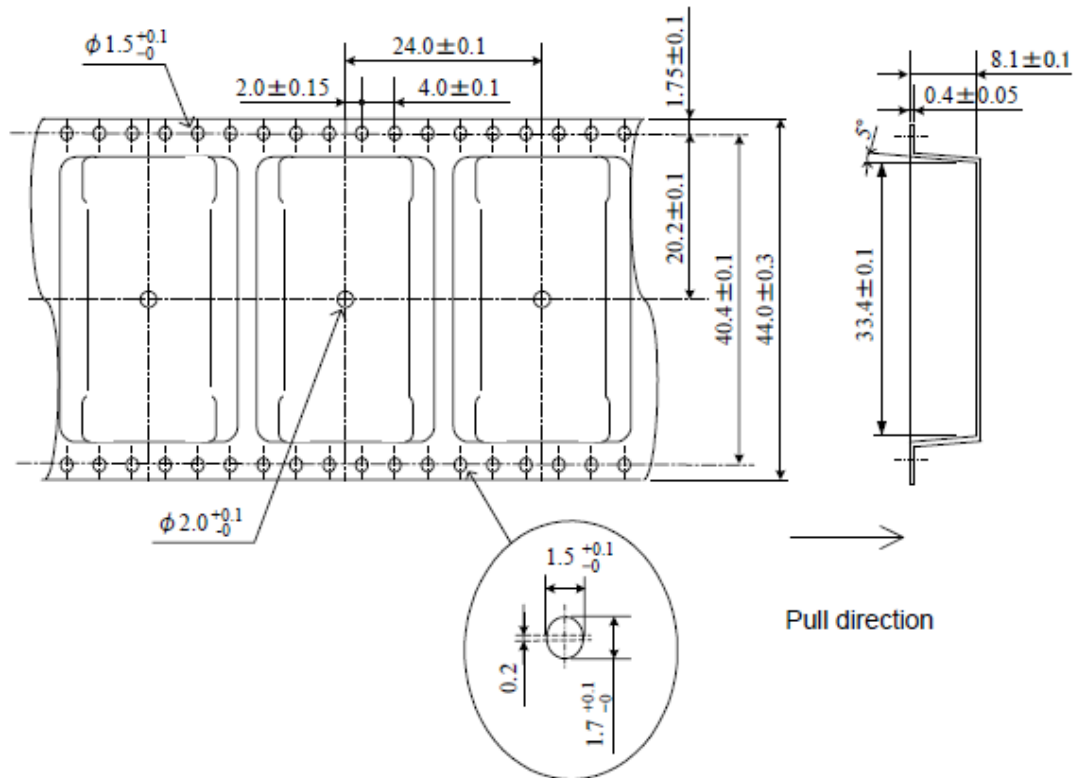

10.2. Real Dimension

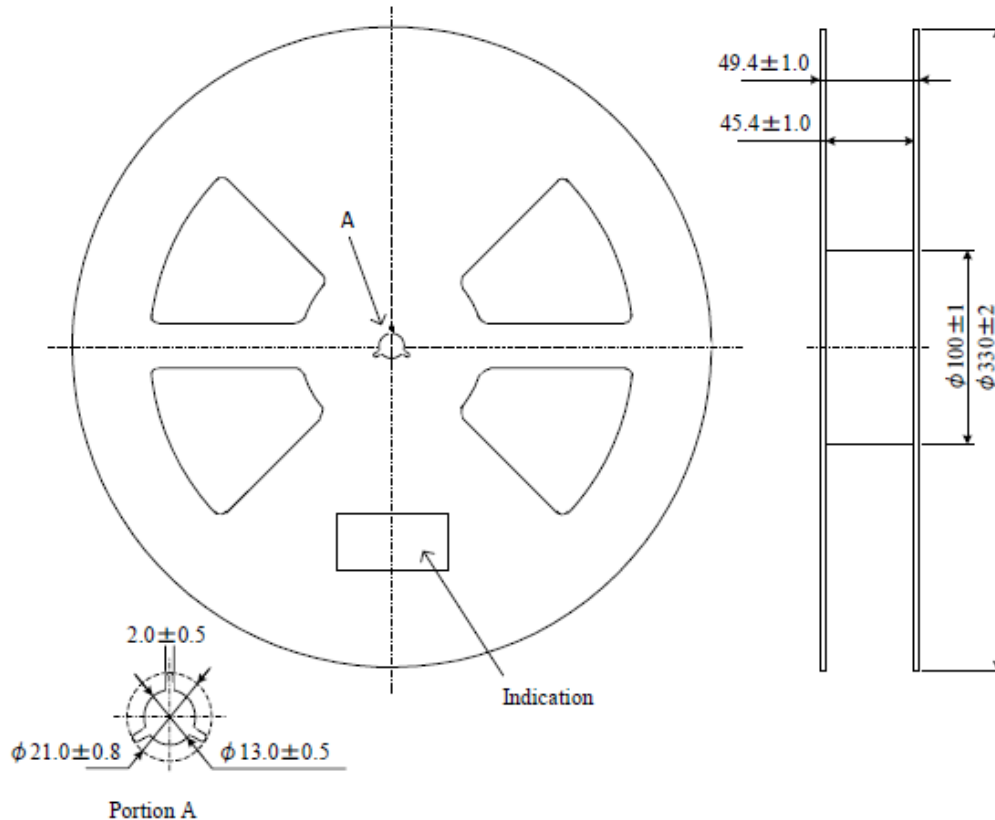

⚠ Note:

1. This datasheet is downloaded from the website of Murata Manufacturing co., Ltd. Therefore, it's specifications are subject to change or our products in it may be discontinued without advance notice. Please check with our sales representatives or product engineers before ordering.
2. This datasheet has only typical specifications because there is no space for detailed specifications. Therefore, please approve our product specifications or transact the approval sheet for product specifications before ordering.

10.3. Taping Specification

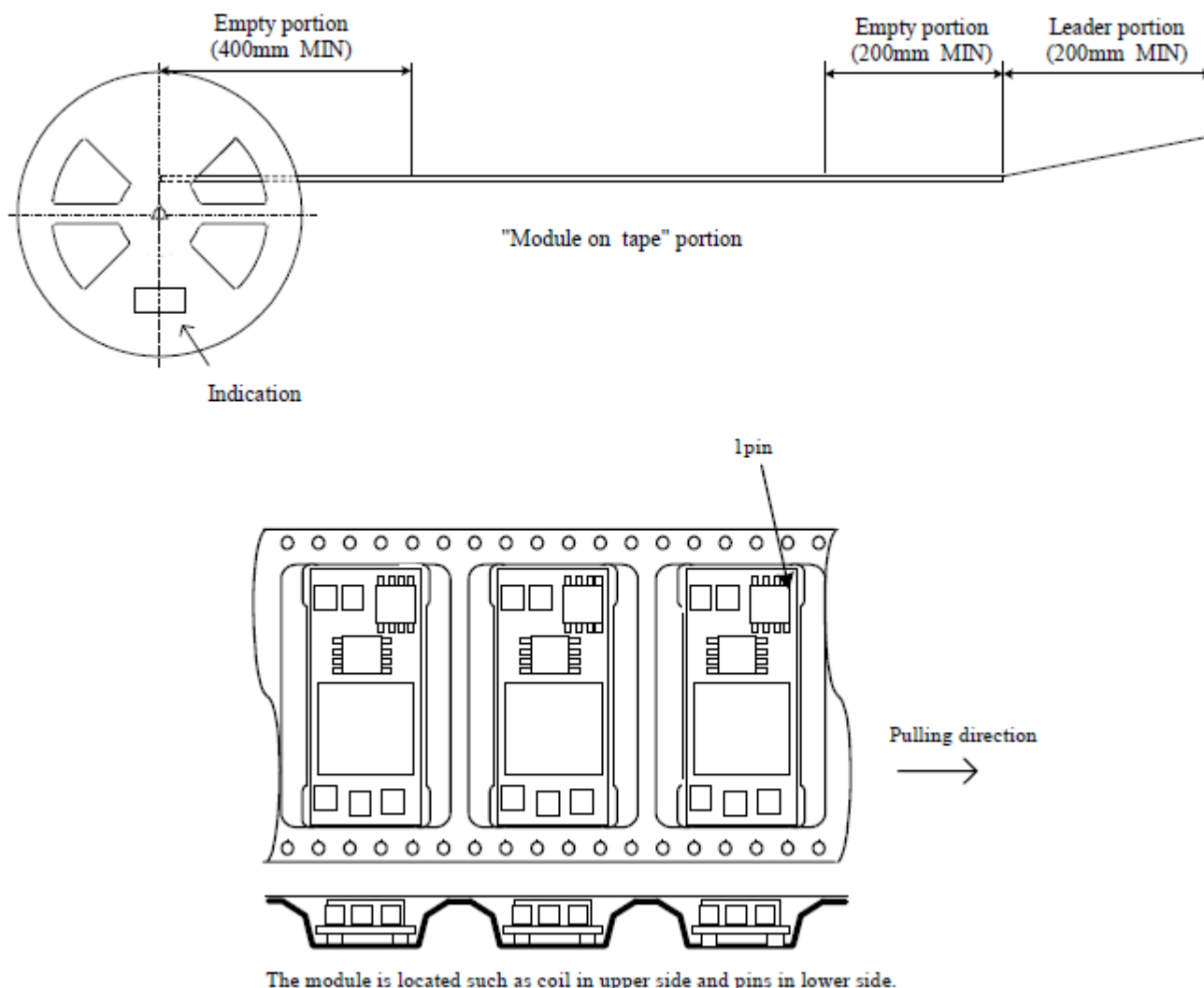

10.4 Note

1. The adhesive strength of the protective tape must be within 0.1-1N.
2. Each reel contains 200pcs.
3. No vacant pocket in "Module on tape" section.
4. The reel is labeled with customer part number, Murata part number and quantity.
5. The color of reel is not specified.

11. Production factory

Komatsu Murata Mfg.Co., Ltd.
 Kanazu Murata Mfg. Co., Ltd.
 Wakura Murata Mfg. Co., Ltd.

Note:

1. This datasheet is downloaded from the website of Murata Manufacturing co., ltd. Therefore, it's specifications are subject to change or our products in it may be discontinued without advance notice. Please check with our sales representatives or product engineers before ordering.
2. This datasheet has only typical specifications because there is no space for detailed specifications. Therefore, please approve our product specifications or transact the approval sheet for product specifications before ordering.

12. Typical Characteristics Data

12.1 Load Transient Response

Our original ripple-detective control method achieves much better load transient responses.

$V_{in}=3.3V$, $V_o=1.8V$, $I_o=8A \rightarrow 16A$, $di/dt=2A/\mu s$, $C_{out}=100\mu F$ (Ceramic)

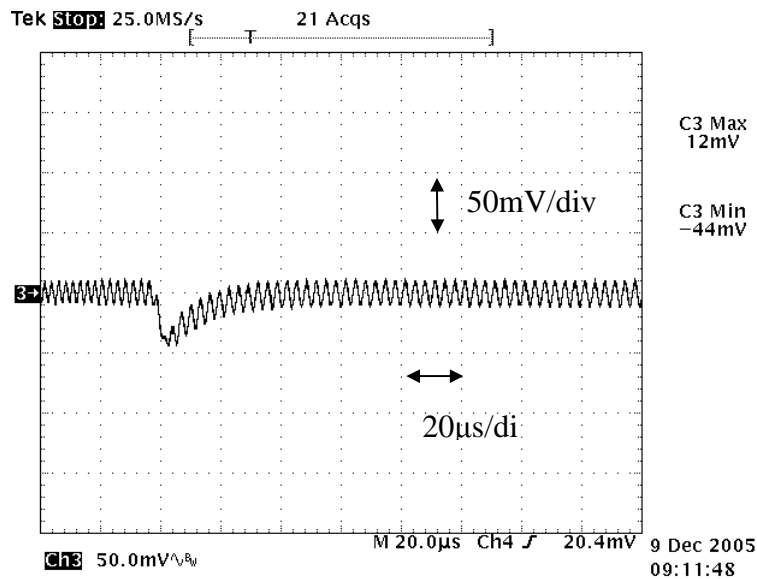

Fig. 12-1. Load Transient Response

12.2 Output Impedance characteristics

Our original ripple-detective control method achieves very low output impedance in wide frequency range.

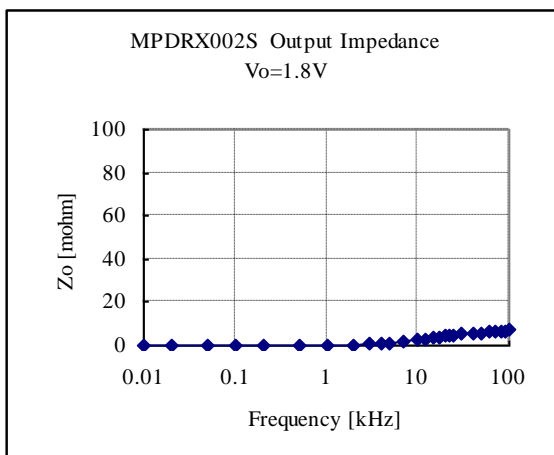

Fig. 12-2-1. Output Impedance of MPDRX002S

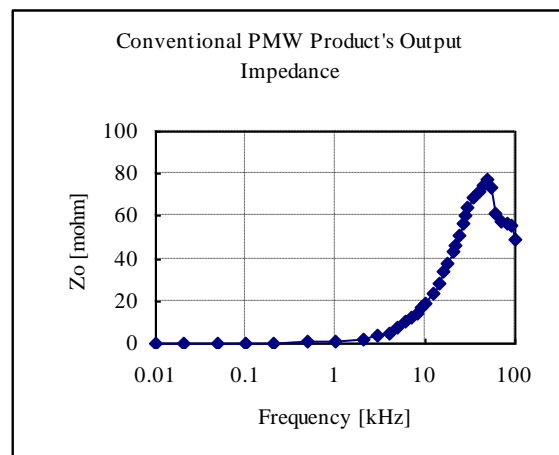

Fig. 12-2-2. Output Impedance of conventional product

Note:

1. This datasheet is downloaded from the website of Murata Manufacturing co., ltd. Therefore, it's specifications are subject to change or our products in it may be discontinued without advance notice. Please check with our sales representatives or product engineers before ordering.
2. This datasheet has only typical specifications because there is no space for detailed specifications. Therefore, please approve our product specifications or transact the approval sheet for product specifications before ordering.

12. 3 Other electrical characteristics

12. 3. 1 $V_{out}=1.8V$

(Ta=25 °C, Cin= EEFUD0J101R, Cout= GRM32EB30J107ME16L, Rtrim=340Ω)

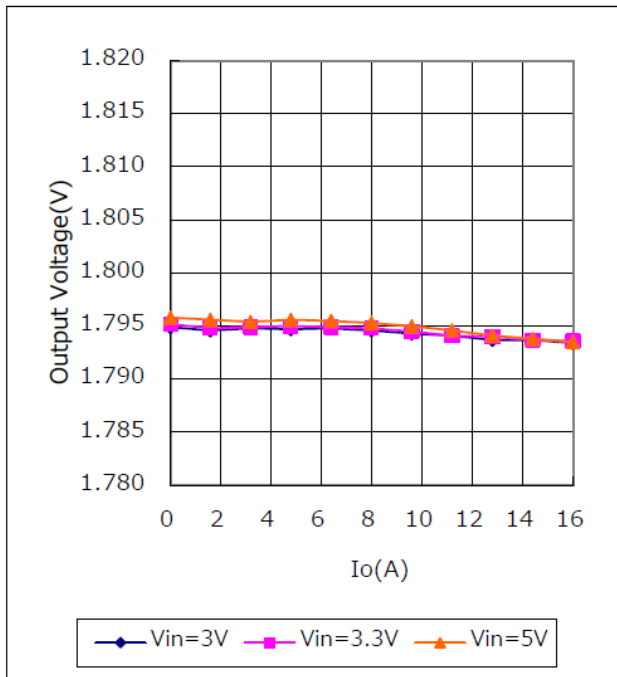

Fig. 12-3-1. Output Voltage v.s. Output Current

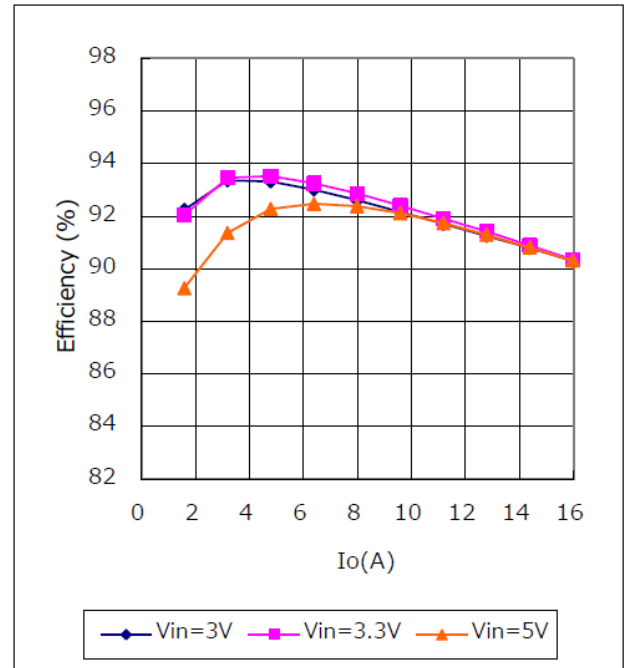

Fig. 12-3-2. Efficiency v.s. Output Current

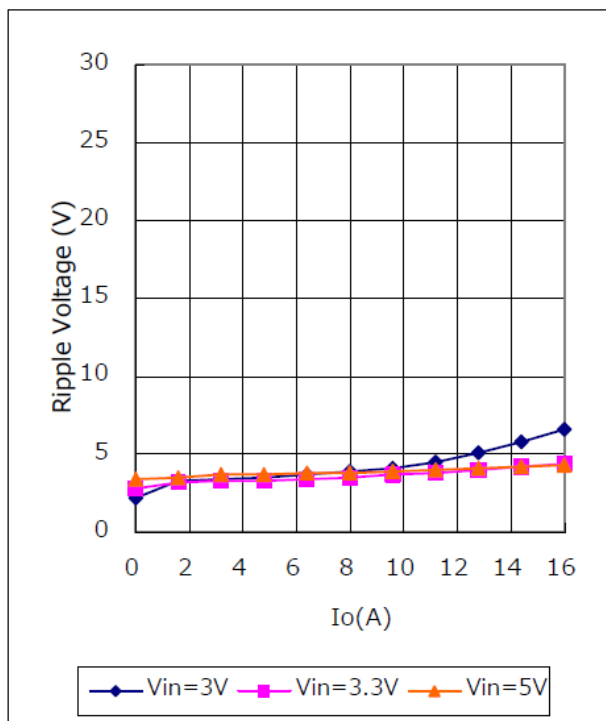

Fig. 12-3-3. Ripple Voltage v.s. Output Current

⚠ Note:

1. This datasheet is downloaded from the website of Murata Manufacturing co., ltd. Therefore, it's specifications are subject to change or our products in it may be discontinued without advance notice. Please check with our sales representatives or product engineers before ordering.
2. This datasheet has only typical specifications because there is no space for detailed specifications. Therefore, please approve our product specifications or transact the approval sheet for product specifications before ordering.

12. 3. 2 $V_{out}=1.2V$

(Ta=25 °C, Cin= EEFUD0J101R, Cout=GRM32EB30J107ME16L, Rtrim=8.5kΩ)

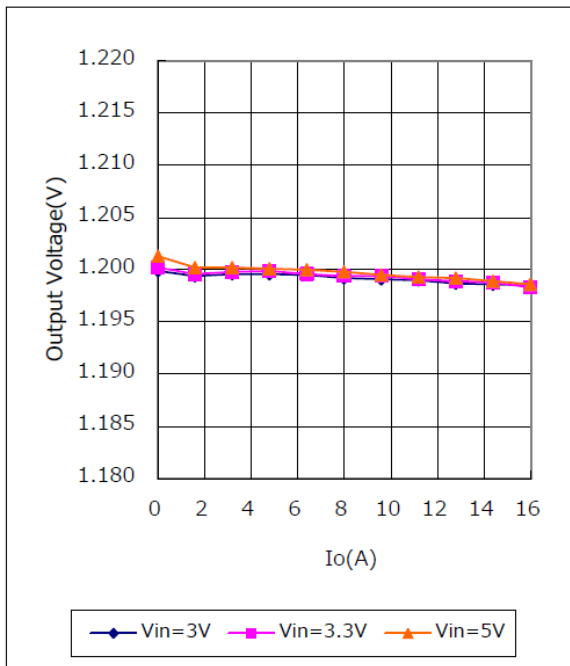

Fig. 12-3-4. Output Voltage v.s. Output Current

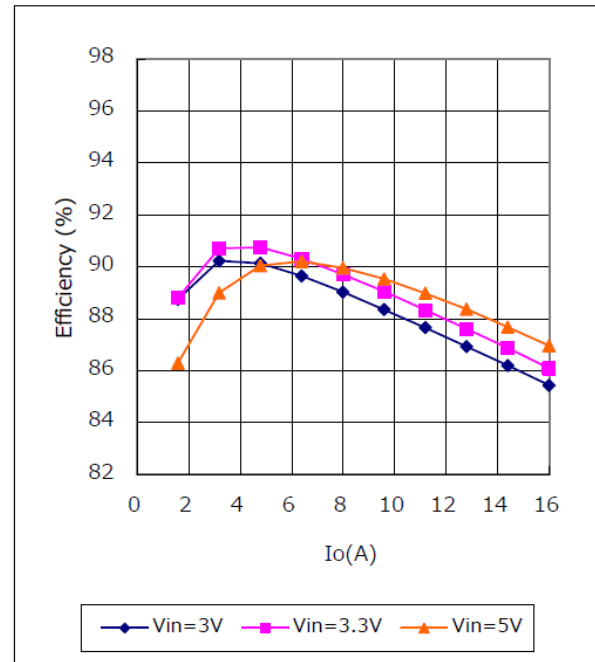

Fig. 12-3-5. Efficiency v.s. Output Current

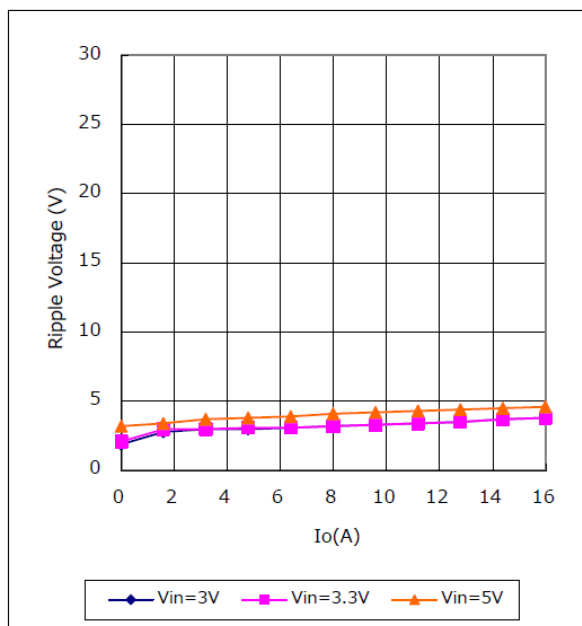

Fig. 12-3-6. Ripple Voltage v.s. Output Current

⚠ Note:

1. This datasheet is downloaded from the website of Murata Manufacturing co., ltd. Therefore, it's specifications are subject to change or our products in it may be discontinued without advance notice. Please check with our sales representatives or product engineers before ordering.
2. This datasheet has only typical specifications because there is no space for detailed specifications. Therefore, please approve our product specifications or transact the approval sheet for product specifications before ordering.

13. Mounting Condition

13.1 PCB Land Pattern Recommendation

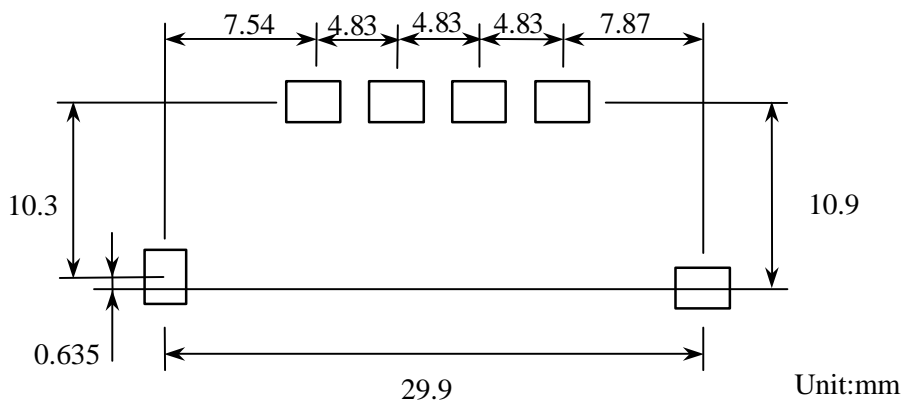

Recommended land size 4mm × 2.5mm

13.2 Recommended Soldering Conditions

Reflow Soldering

This product is RoHS compatible. The following profile is recommended for the reflow of this product using Pb-free solder paste (Sn-Ag-Cu).

Reflow Soldering Profile

Method	: Full convection reflow soldering
Soldering temperature	: 245°C +0/-5°C (Parts surface temperature)
Soldering time	: 20 to 60 seconds max. (Over 220°C)
Preheating	: 60 to 150 seconds (150-200°C)
Time	: 1 time

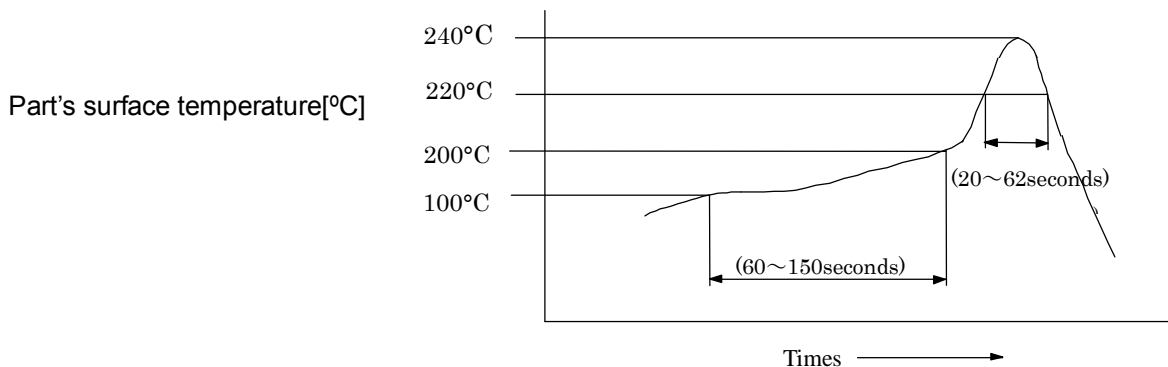

※Do not vibrate for the products on reflow.

Please need to take care temperature control because mounted parts may come off if the product are left under the high temperature.

Do not reflow DC-DC converter as follows, because DC-DC converter may fall down from a substrate during reflowing.

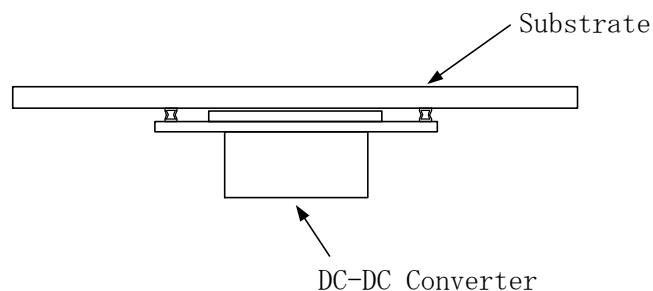

Note:

1. This datasheet is downloaded from the website of Murata Manufacturing co., ltd. Therefore, it's specifications are subject to change or our products in it may be discontinued without advance notice. Please check with our sales representatives or product engineers before ordering.
2. This datasheet has only typical specifications because there is no space for detailed specifications. Therefore, please approve our product specifications or transact the approval sheet for product specifications before ordering.

14. Notice

14. 1. Both input-side and output side, please make the wiring loop between plus and minus as small as possible. The influence of a leakage inductance can be reduced.
14. 2. Please make the power line pattern as wide and short as possible. The Following figure is an example of recommendable PCB design.

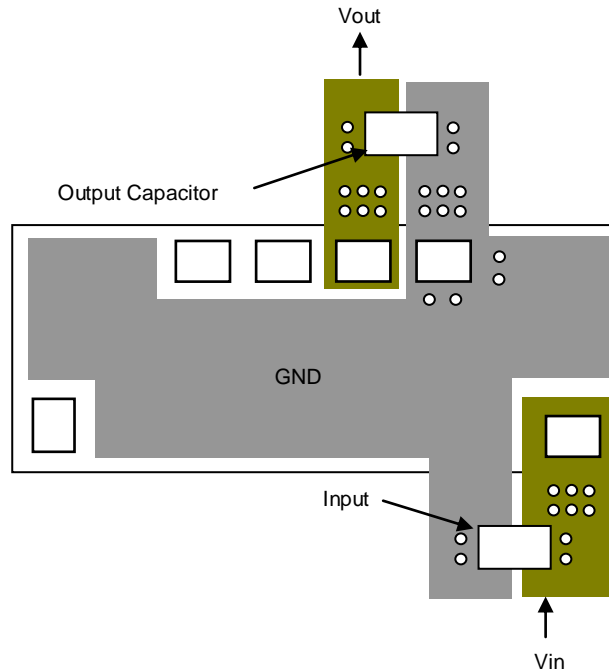

14. 3. This product should not be operated in parallel or in series.
14. 4. Please do not use a connector or a socket to connect this product to your product. The electric characteristics may be deteriorated by the influence of contact resistance.
14. 5. Be sure to provide an appropriate fail-safe function on your product to prevent secondary damage that may be caused due to abnormal functional or failure of this product.
14. 6. Inrush current protection is not a feature of this product.
14. 7. Be sure not to warp your PCB over $90\mu\text{m}$. If not, the parts on the backside of this device touch on your PCB, and that may lead to cracks of the backside parts or reliability deterioration of this device.

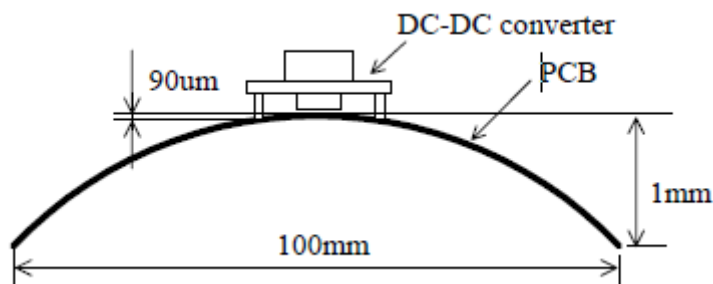

 **Note:**

1. This datasheet is downloaded from the website of Murata Manufacturing co., ltd. Therefore, it's specifications are subject to change or our products in it may be discontinued without advance notice. Please check with our sales representatives or product engineers before ordering.
2. This datasheet has only typical specifications because there is no space for detailed specifications. Therefore, please approve our product specifications or transact the approval sheet for product specifications before ordering.

14. 8. Please connect the input terminals with the correct polarity. If an error in polarity connection is made this product may be damaged. If this product is damaged internally, an elevated input current may flow, and so this product may exhibit an abnormal temperature rise, or your product may be damaged. Please add a diode and fuse per the following diagram to protect them.

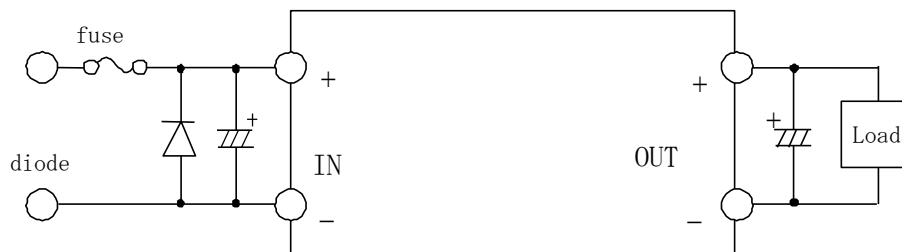

※Please select diode and fuse after confirming the operation of your product.

14. 9. Cleaning

Please use no-clean type flux and do not wash this product.

14. 10. Storage

14. 10. 1. This product should be treated as MSL2 product when it is reflowed according to recommended soldering conditions described in section 13. 2. .
This product can be stored for up to 1 year at below 30°C/60%R.H., without requiring an additional baking process.

If stored for over 1 year, baking of this product before soldering is recommended.

The recommended baking condition of individual products is 125±5°C / 24 hours.

If products are baked in the manufacturer's tray or in manufacturer's tape, 40±5°C/5%/192 hours is recommended.

Please avoid dampness and heat or locations where temperatures may vary widely to avoid Possible water condensation on the product. Exposure to such environments may degrade the performance and/or the reliability of the product.

If the product must be stored for a longer time than 1 year it is recommend that solder ability be tested regularly to confirm material degradation has not occurred.

14. 10. 2 Please do not store this product in places such as :

A dusty place, a place exposed directly to sea breeze, or in an atmosphere containing corrosive gas (Cl₂,NH₃,SO₂,NO_X and so on).

Note:

1. This datasheet is downloaded from the website of Murata Manufacturing co., ltd. Therefore, it' s specifications are subject to change or our products in it may be discontinued without advance notice. Please check with our sales representatives or product engineers before ordering.
2. This datasheet has only typical specifications because there is no space for detailed specifications. Therefore, please approve our product specifications or transact the approval sheet for product specifications before ordering.

14. 11 Operational Environment and Operational Conditions

14. 11. 1. Operational Environment

This product is not water-, chemical- or corrosion-proof.

In order to prevent leakage of electricity and abnormal temperature rise of the product, do not operate under the following environmental conditions:

- (1) An atmosphere containing corrosive gas (Cl₂, NH₃, SO₂, NO_x and so on)
- (2) A high-dust environment
- (3) Under the exposure of direct sunlight
- (4) A location where the likelihood of exposure to water or water condensation exists.
- (5) A location exposed to ocean air
- (6) Any locations similar to the above

14. 11. 2. Operational Conditions

Please use this product within specified values (power supply, temperature, input, output and load condition, and so on). If the product is exposed to conditions outside of the specified values reliability of the product may be adversely effected.

14. 11. 3. Note prior to use

Diminished reliability and/ or failure may result if the product is exposed to a high-level static charge, over-rated voltage or reverse voltage. Please avoid the following conditions be avoided prior to use of the product:

- (1) Supply of power outside of rated values (see section 8)
- (2) Supply of reverse power or inadequate connection of a 0 V(DC)line
- (3) Electrostatic discharge from production line and/ or operator
- (4) Electrification of the product from electrostatic induction
- (5) Excessive mechanical shock

14. 12. Transportation

Murata recommends that when transporting this product, it be packed so as to avoid damage by mechanical

vibration or exposure to adverse conditions such as ocean air, high humidity. It is additionally recommended

that appropriate instructions and guidelines be communicated to carriers to prevent exposure to these same conditions.



Note

1. Murata recommends that customers ensure that the evaluation and testing of these devices are completed with this product actually assembled on their product.
2. Please contact our main sales office or nearby sales office before using our products for the applications listed below which require especially high reliability for the prevention of defects which might directly cause damage to the third party's life, body or property or this products for any other applications that described in the above.
 - ① Aircraft equipment
 - ② Aerospace equipment
 - ③ Undersea equipment
 - ④ Power plant control equipment
 - ⑤ Medical equipment
 - ⑥ Transportation equipment (vehicles, trains, ships, etc.)
 - ⑦ Traffic signal equipment
 - ⑧ Disaster prevention /crime prevention equipment
 - ⑨ Data-processing equipment
 - ⑩ Application of similar complexity and/or reliability requirements to the applications listed in the above.
3. This catalog is indicated in March 2006. About the written contents, since changing without a preliminary announcement for improvement and supply are sometimes stopped, please confirm in case of ordering. If written contents are unknown, please ask to our main sales office or nearby sales office.

Note:

1. This datasheet is downloaded from the website of Murata Manufacturing co., Ltd. Therefore, it's specifications are subject to change or our products in it may be discontinued without advance notice. Please check with our sales representatives or product engineers before ordering.
2. This datasheet has only typical specifications because there is no space for detailed specifications. Therefore, please approve our product specifications or transact the approval sheet for product specifications before ordering.