

# LOW PROFILE SHIELDED SMD CHIP POWER INDUCTOR



4.0 x 4.0 x 1.2mm

ASPI-0412FS



**RoHS**  
Compliant

## FEATURES:

- Small size and low profile: 1.2mm max
- Small DCR and high rated current
- High reliability to mechanical strength
- Shielded by magnetic powder molding
- Suitable for RoHS compliant Reflow

## APPLICATIONS:

- Mobile phones
- MP3, MP4 and other portable / communication products
- Digital cameras.

## ELECTRICAL SPECIFICATIONS:

Abracon P/N:	ASPI-0412FS Series
Operating Temperature & Humidity :	-30°C to +100°C, 5% to 85% RH
Storage Temperature & Humidity:	-20°C to +60°C, 5% to 85% RH

Part Number	Inductance	DCR	Saturation Current	Temperature Rise Current	Marking
Units	$\mu\text{H} \pm 20\%$	$\text{m}\Omega \pm 20\%$	A	A	-
Symbol	L	DCR	Isat*	Irms*	-
ASPI-0412FS-2R2M	2.2	70	1.80	1.65	2R2
ASPI-0412FS-3R3M	3.3	100	1.55	1.40	3R3
ASPI-0412FS-4R7M	4.7	130	1.20	1.15	4R7
ASPI-0412FS-6R8M	6.8	180	1.05	0.95	6R8
ASPI-0412FS-100M	10	240	0.85	0.90	100
ASPI-0412FS-220M	22	550	0.60	0.55	220

\*The rated current is subject to change depending upon the temperature cooling condition.

### Test Conditions

Inductance: 100kHz, 0.3V, Ta=20°C

DCR: Ta=20°C

Isat:  $\Delta L/L$  (initial)  $\geq -30\%$

Irms:  $\Delta T \leq 40^\circ\text{C}$

## OPTIONS AND PART IDENTIFICATION

ASPI-0412FS -  -

### Inductance Code

Please refer to the table above

### Packaging

T: Tape and Reel (1kpcs / reel)

T4: Tape and Reel (4kpcs / reel)

# LOW PROFILE SHIELDED SMD CHIP POWER INDUCTOR



4.0 x 4.0 x 1.2mm

ASPI-0412FS



**RoHS**  
Compliant

## OUTLINE DRAWING:

### Mechanical Dimensions

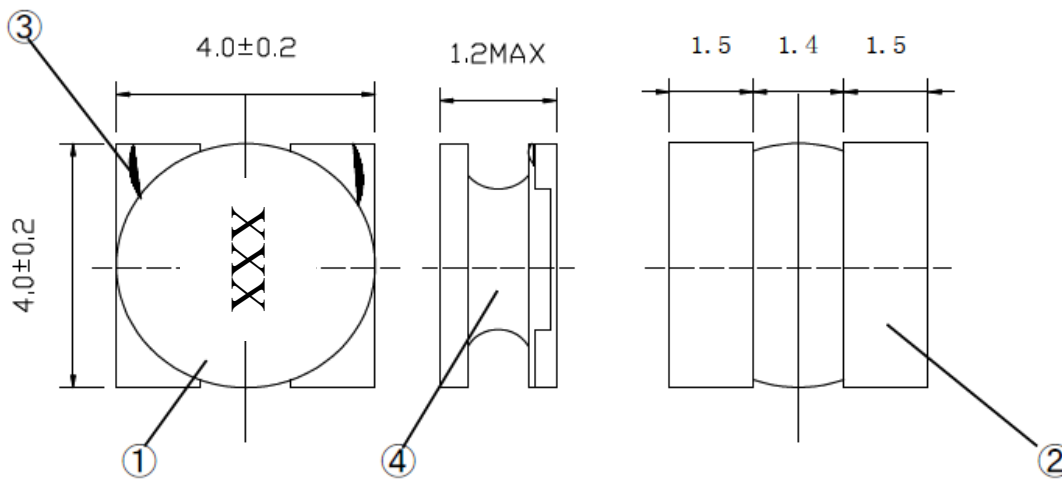

### Circuit Schematic

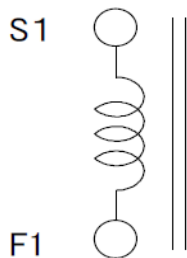

### Recommended Land Pattern

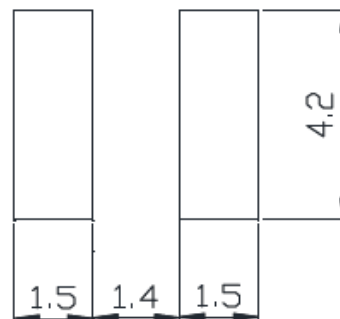

No	Part Name	Material
1	Drum core	Ni-Zn Ferrite
2	Terminals	Copper alloy, Sn
3	Coil	Cu/UEW
4	Adhesive	Epoxy base resin
	Magnetic powder	Ni-Zn Ferrite

Dimension: mm

# LOW PROFILE SHIELDED SMD CHIP POWER INDUCTOR



4.0 x 4.0 x 1.2mm

ASPI-0412FS



RoHS  
Compliant

## TAPE & REEL:

T: 1,000pcs / reel  
T4: 4,000pcs / reel

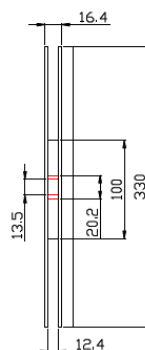
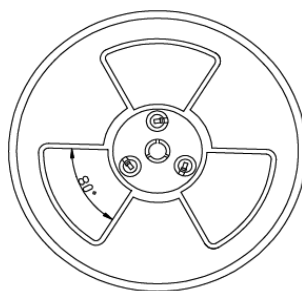
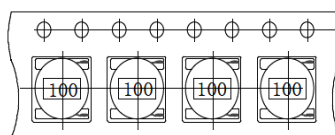
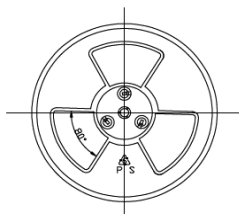
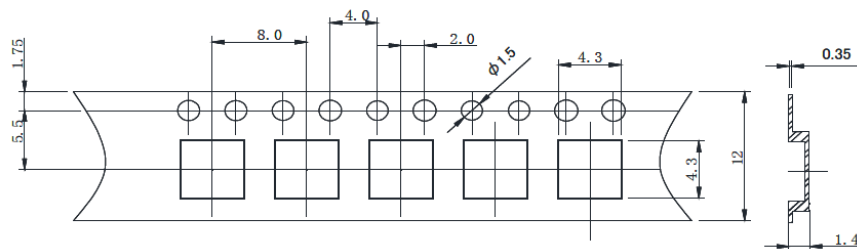

Dimension: mm

## REFLOW PROFILE:

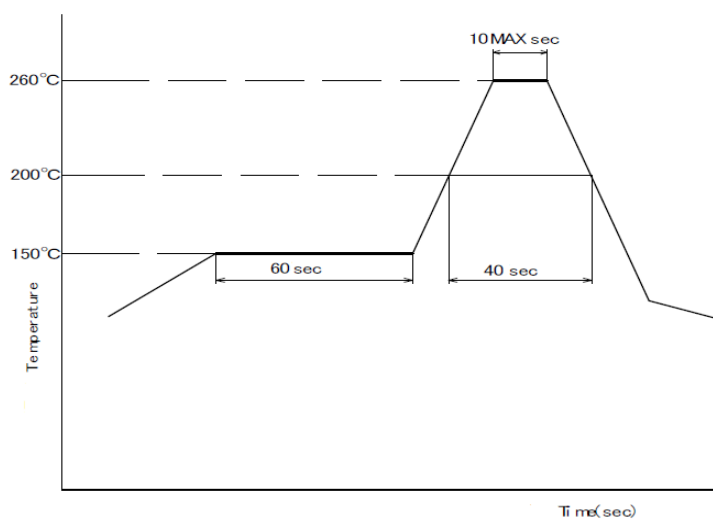

**ATTENTION:** Abracon Corporation's products are COTS – Commercial-Off-The-Shelf products; suitable for Commercial, Industrial and, where designated, Automotive Applications. Abracon's products are not specifically designed for Military, Aviation, Aerospace, Life-dependant Medical applications or any application requiring high reliability where component failure could result in loss of life and/or property. For applications requiring high reliability and/or presenting an extreme operating environment, written consent and authorization from Abracon Corporation is required. Please contact Abracon Corporation for more information.

ABRACON IS  
ISO9001:2008  
CERTIFIED



**ABRACON**  
CORPORATION

Visit [www.abracon.com](http://www.abracon.com) for Terms & Conditions of Sale  
30332 Esperanza, Rancho Santa Margarita, California 92688  
tel 949-546-8000 | fax 949-546-8001 | [www.abracon.com](http://www.abracon.com)

Revised: 04.29.11