

Low Power, 1.6 μ A LDO Regulator

FEATURES

- Maximum Output Current: more than 150mA
- Dropout Voltage: 450 mV @ 100mA (Vout=1.5V)
- Low Power Consumption: 1.6 μ A (TYP.)
- Maximum Operating Voltage: 5.5V
- Output Voltage Range: 1.2V to 2.5V
- Input Voltage Range: 1.8V to 5.5V
- Highly Accurate: $\pm 2\%$
- Operational Temperature Range: $-40^{\circ}\text{C} \sim 85^{\circ}\text{C}$
- Ultra Small Packages: SOT-23-3L and SOT-89-3L
- Low ESR capacitor ceramic compatible

DESCRIPTION

The FT511xx series are precise, extra low power consumption, positive voltage regulators with a significantly small dropout voltage. Each device contains a current limiter circuit, a PMOS power transistor, a precision reference voltage and an error amplifier circuit.

The FT511xx has been designed to be used with low capacitors and requires a minimum output capacitor of 1.0 μ F. Standard output voltage versions are 1.2V, 1.5V, 1.8V, 2.5V

APPLICATIONS

- Battery Powered Equipment
- Cellular Phones
- Digital Cameras, Video Cameras
- Portable AV Systems
- Communication Tools
- Portable Games

TYPICAL APPLICATION CIRCUIT

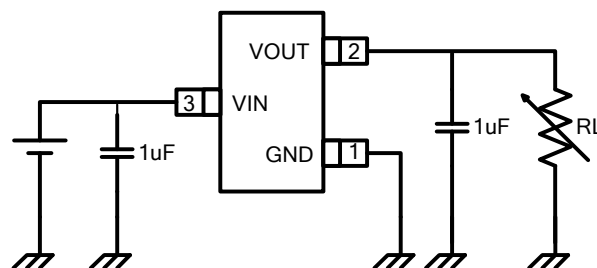

Typical Application Circuit

ABSOLUTE MAXIMUM RATINGS*

Operating Ambient Temperature	-----	-40°C to 85°C
Storage Temperature	-----	-55°C to 125°C
Maximum Voltage	-----	6V
Output Current	-----	400mA
Power Dissipation	-----	400mW
ESD Protection HBM	-----	2000V
ESD Protection MM	-----	200V

* Stresses exceed those listed under “Absolute Maximum Ratings” may cause permanent damage to the device. Functional operation of the device at conditions beyond those listed in the specification is not guaranteed. Prolonged exposure to extreme conditions may affect device reliability or functionality.

PIN CONFIGURATION

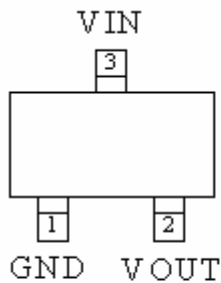

SOT-23-3LA

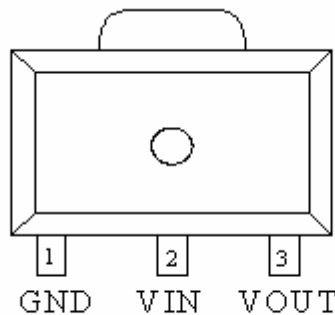

SOT-89-3LA

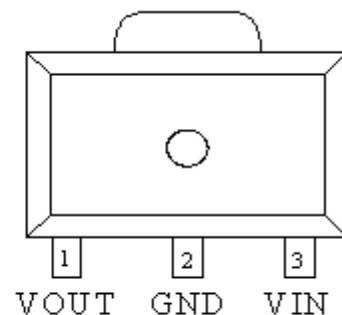

SOT-89-3LB

TERMINAL FUNCTION

Pin Name	Pin Function
VIN	Power Input Voltage
VOUT	Output Voltage
GND	Ground

ORDERING INFORMATION

FT511①②

DESIGNATOR	SYMBOL	OUTPUT VOLTAGE
①	A	1.2V
	B	1.5V
	C	1.8V
	D	2.5V

DESIGNATOR	SYMBOL	PACKAGE TYPE
②	a	SOT-23-3LA
	b	SOT-89-3LA
	c	SOT-89-3LB

MARKING RULE

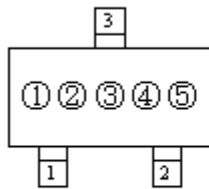

SOT-23-3L
(TOP-VIEW)

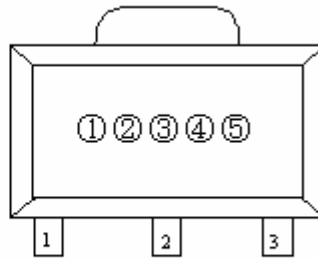

SOT-89-3L
(TOP-VIEW)

① **Represent Product Series**

SYMBOL	PRODUCT SERIES
3	FT511xx

② Represent Output Voltage and operating temperature range

B represent the output voltage is 1.5V, operating temperature is -40C ~ 85C.

③④⑤For internal reference.

BLOCK DIAGRAM

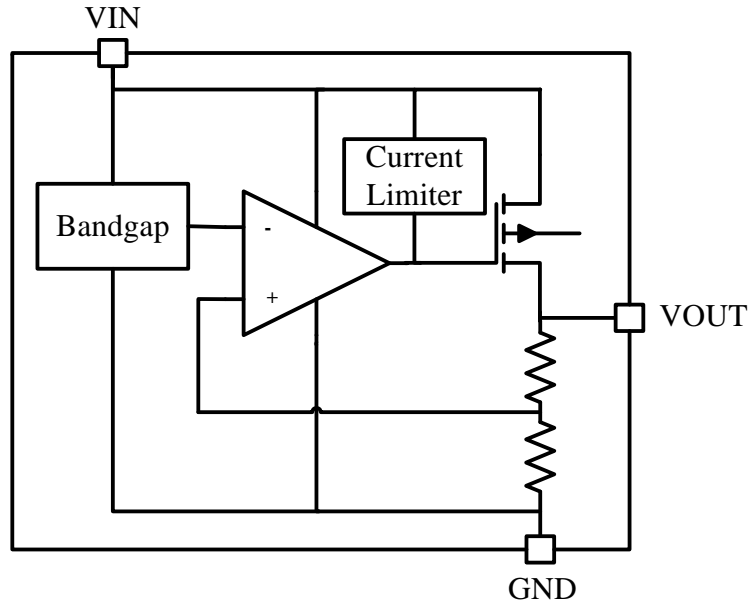

Block Diagram

ELECTRICAL CHARACTERISTICS

$V_{in}=V_{out}+1V$; $C_{in}=1.0\mu F$; $V_{out}=1.2V$

PARAMETER	SYMBOL	CONDITIONS	MIN	TYP	MAX	UNITS
Output Voltage	V_{out}	$I_{out}=1mA$	1.176	1.200	1.224	V
Input Voltage	V_{in}		1.8		5.5	V
Maximum Output Current	I_{max}	$V_{in}=V_{out}+1V$	150			mA
Load Regulation	ΔV_{out}	$1mA \leq I_{out} \leq 100mA$		25		mV
Dropout Voltage **	V_{drp}	$I_{out}=100mA$		700		mV
Supply Current	I_q	$V_{in}=2.5V$		1.6		μA
Line Regulation	$\frac{\Delta V_{out}}{(\Delta V_{in} * V_{out})}$	$V_{out}+1.0V \leq V_{in} \leq 5.5V$ $I_{out}=1mA$		0.04	0.3	%/V
Output Voltage Temperature Characteristics	$\frac{\Delta V_{out}}{(\Delta Temp * V_{out})}$	$I_{out}=1mA$ $-40^{\circ}C \leq Temp \leq 85^{\circ}C$		100		ppm/C
Current Limiter	I_{short}	$V_{in}=V_{out}+1V$		70		mA



Vin=Vout+1V; Cin=1.0uF; Vout=1.5V

PARAMETER	SYMBOL	CONDITIONS	MIN	TYP	MAX	UNITS
Output Voltage	Vout	Iout=1mA	1.470	1.500	1.530	V
Input Voltage	Vin		1.8		5.5	V
Maximum Output Current	I _{max}	Vin=Vout+1V	150			mA
Load Regulation	ΔVout	1mA ≤ Iout ≤ 100mA		25		mV
Dropout Voltage **	V _{drp}	Iout=100 mA		450		mV
Supply Current	I _q	Vin=2.5V		1.6		uA
Line Regulation	ΔVout / (ΔVin* Vout)	Vout+1.0V ≤ Vin ≤ 5.5V Iout=1mA		0.04	0.3	%/V
Output Voltage Temperature Characteristics	ΔVout / (ΔTemp* Vout)	Iout=1mA -40°C ≤ Temp ≤ 85°C		100		ppm/C
Current Limiter	I _{short}	Vin=Vout+1V		70		mA

Vin=Vout+1V; Cin=1.0uF; Vout=1.8V

PARAMETER	SYMBOL	CONDITIONS	MIN	TYP	MAX	UNITS
Output Voltage	Vout	Iout=40mA	1.764	1.800	1.836	V
Input Voltage	Vin		1.8		5.5	V
Maximum Output Current	I _{max}	Vin=Vout+1V	150			mA
Load Regulation	ΔVout	1mA ≤ Iout ≤ 100mA		25		mV
Dropout Voltage **	V _{drp}	Iout=100 mA		300		mV
Supply Current	I _q	Vin=2.5V		1.6		uA
Line Regulation	ΔVout / (ΔVin* Vout)	Vout+1.0V ≤ Vin ≤ 5.5V Iout=40mA		0.04	0.3	%/V
Output Voltage Temperature Characteristics	ΔVout / (ΔTemp* Vout)	Iout=40mA -40°C ≤ Temp ≤ 85°C		100		ppm/C
Current Limiter	I _{short}	Vin=Vout+1V		70		mA



Vin=Vout+1V; Cin=1.0uF; Vout=2.5V

PARAMETER	SYMBOL	CONDITIONS	MIN	TYP	MAX	UNITS
Output Voltage	Vout	Iout=1mA	2.450	2.500	2.550	V
Input Voltage	Vin		1.8		5.5	V
Maximum Output Current	I _{max}	Vin=Vout+1V	150			mA
Load Regulation	ΔV_{out}	1mA ≤ Iout ≤ 100mA		25		mV
Dropout Voltage **	V _{drp}	Iout=100 mA		220		mV
Supply Current	I _q	Vin=2.5V		1.6		uA
Line Regulation	$\Delta V_{out} / (\Delta V_{in} * V_{out})$	Vout+1.0V ≤ Vin ≤ 5.5V Iout=1mA		0.04	0.3	%/V
Output Voltage Temperature Characteristics	$\Delta V_{out} / (\Delta Temp * V_{out})$	Iout=1mA -40°C ≤ Temp ≤ 85°C		100		ppm/C
Current Limiter	I _{short}	Vin=Vout+1V		70		mA

** Dropout voltage is defined as the input to output differential at which the output voltage drops 2% below its nominal value measured at 1V differential.

TYPICAL PERFORMANCE CHARACTERISTICS FT511B

$V_{out}=1.5V$, $V_{in}=2.5V$, $C_{in}=C_{o}=1\mu F$, $temp=27C$ unless otherwise noted

1. Output Voltage vs. Output Current

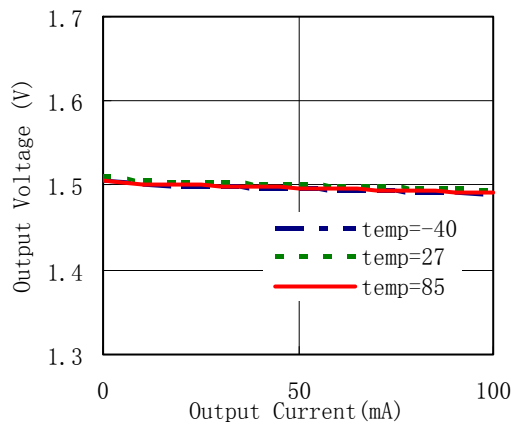

2. Output Voltage vs. Input Voltage

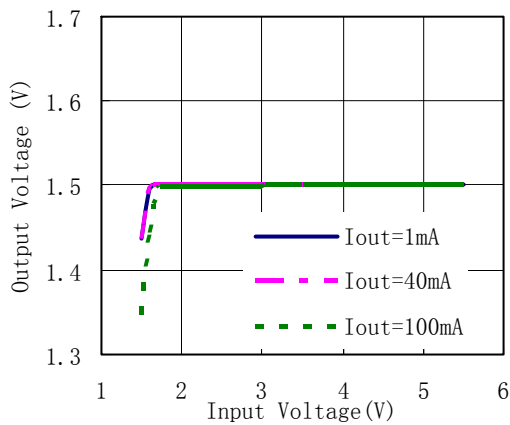

3. Supply Current vs. Input Voltage

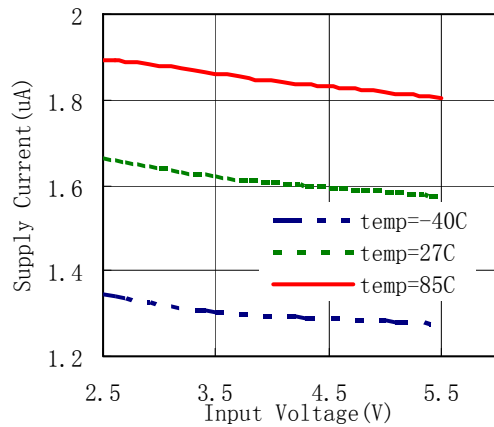

4. Output Voltage vs. Temperature

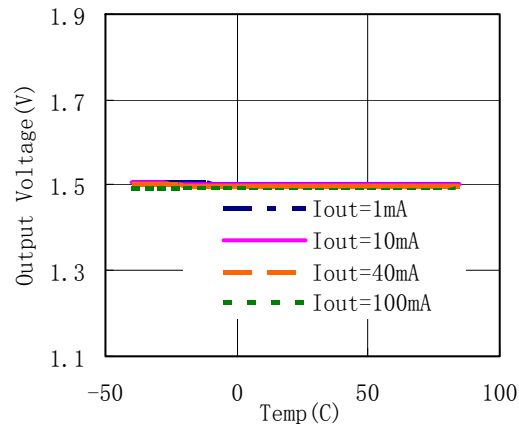

5. Input Transient Response(1)

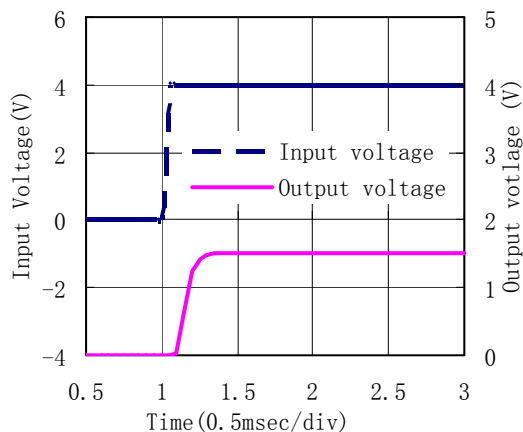

6. Input Transient Response(2)

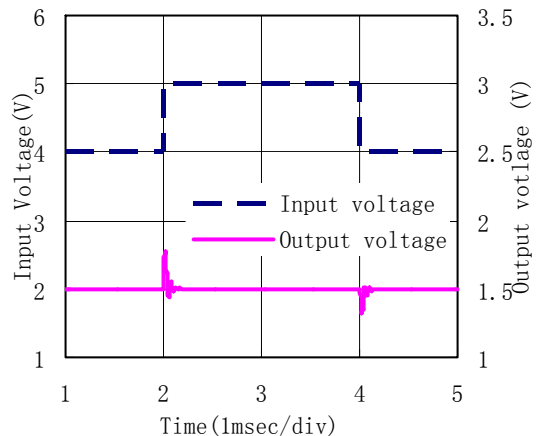

7. Load Transient Response

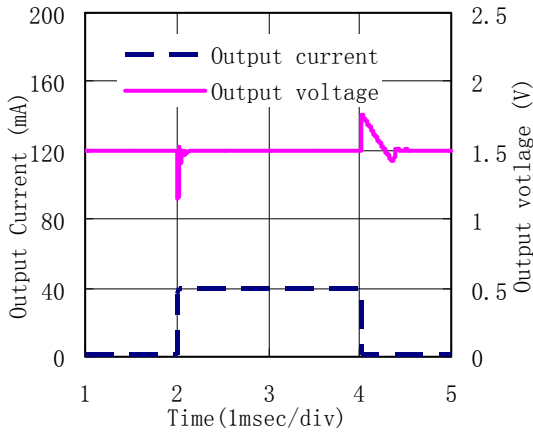

8. Current Limiting

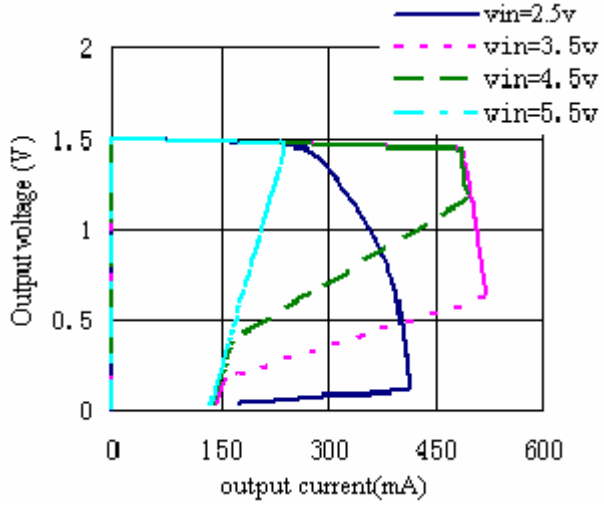

9. Power Supply Ripple Rejection

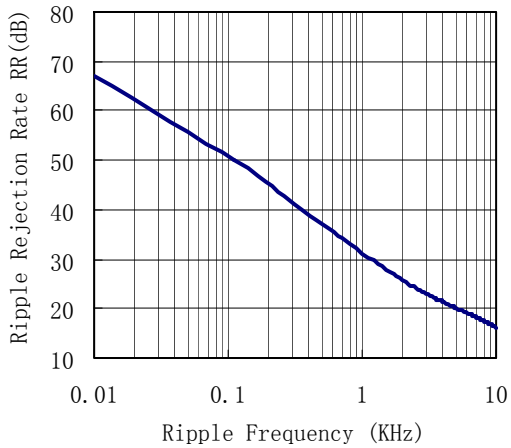

PACKAGING INFORMATION

SOT-23-3L

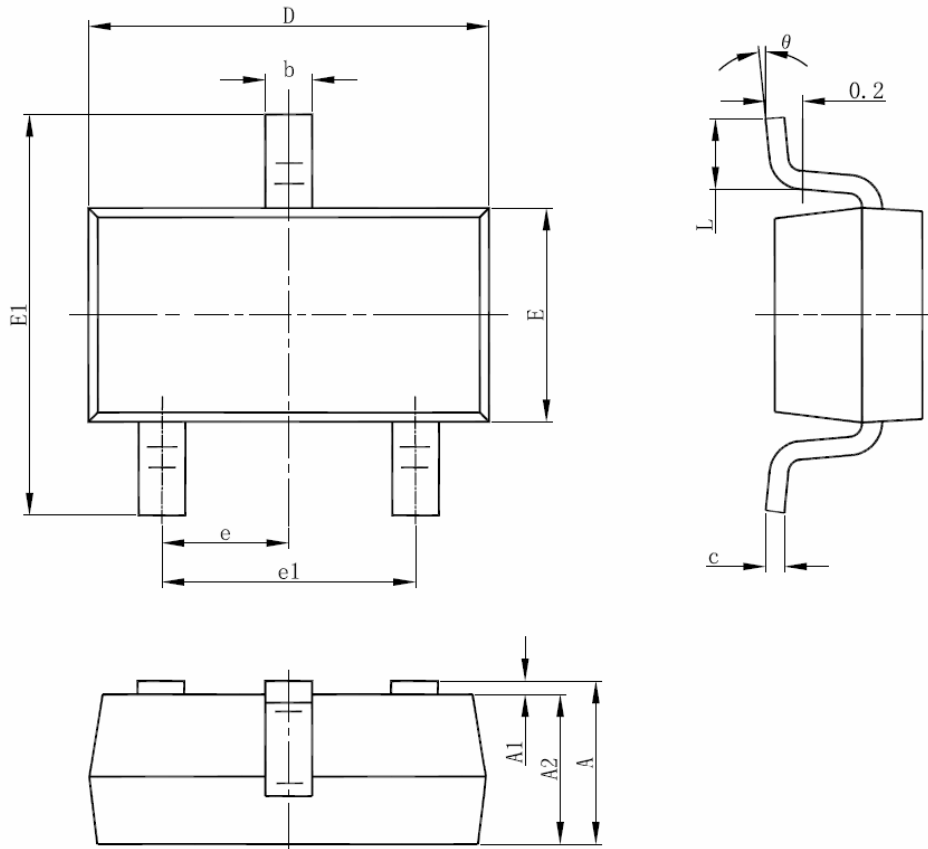

Symbol	Dimensions In Millimeters		Dimensions In Inches	
	Min	Max	Min	Max
A	1.050	1.250	0.041	0.049
A1	0.000	0.100	0.000	0.004
A2	1.050	1.150	0.041	0.045
b	0.300	0.500	0.012	0.020
c	0.100	0.200	0.004	0.008
D	2.820	3.020	0.111	0.119
E	1.500	1.700	0.059	0.067
E1	2.650	2.950	0.104	0.116
e	0.950(BSC)		0.037(BSC)	
e1	1.800	2.000	0.071	0.079
L	0.300	0.600	0.012	0.024
θ	0°	8°	0°	8°

SOT-89-3L

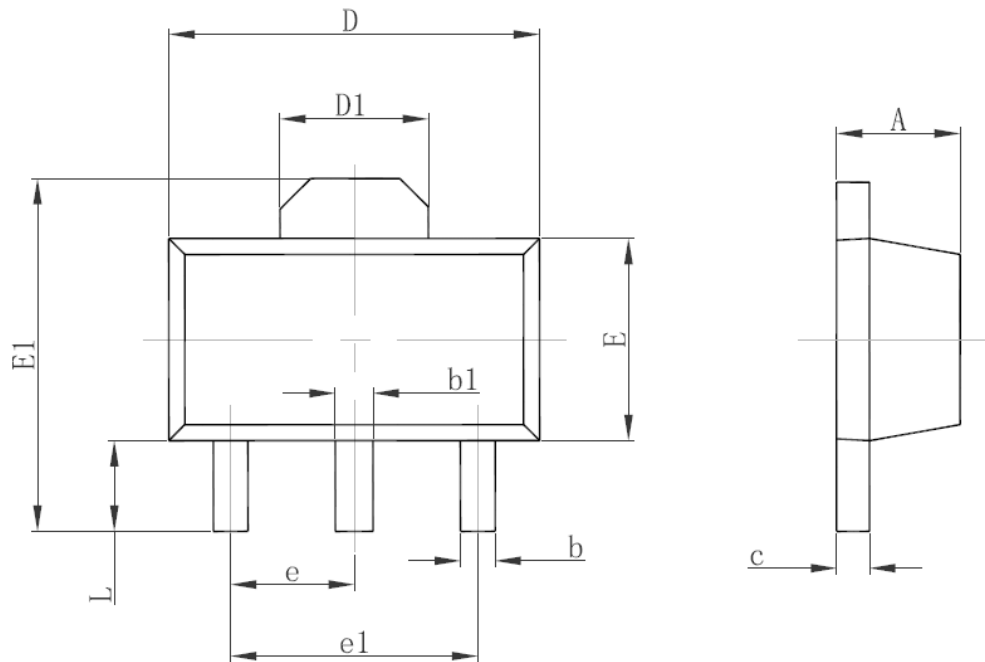

Symbol	Dimensions In Millimeters		Dimensions In Inches	
	Min	Max	Min	Max
A	1.400	1.600	0.055	0.063
b	0.320	0.520	0.013	0.020
b1	0.400	0.580	0.016	0.023
c	0.350	0.440	0.014	0.017
D	4.400	4.600	0.173	0.181
D1	1.550 REF.		0.061 REF.	
E	2.300	2.600	0.091	0.102
E1	3.940	4.250	0.155	0.167
e	1.500 TYP.		0.060 TYP.	
e1	3.000 TYP.		0.118 TYP.	
L	0.900	1.200	0.035	0.047