

Standard Rectifier Module

| | |
|-------------------------|----------|
| 1~ Rectifier | |
| V_{RRM} | = 800 V |
| I_{DAV} | = 100 A |
| I_{FSM} | = 1500 A |

1~ Rectifier Bridge

Part number

VBO105-08NO7

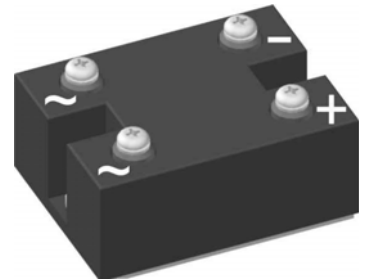

 E72873

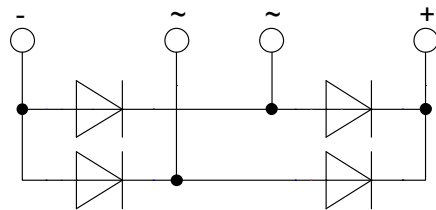

Features / Advantages:

- Package with DCB ceramic
- Improved temperature and power cycling
- Planar passivated chips
- Very low forward voltage drop
- Very low leakage current

Applications:

- Diode for main rectification
- For one phase bridge configurations
- Supplies for DC power equipment
- Input rectifiers for PWM inverter
- Battery DC power supplies
- Field supply for DC motors

Package: PWS-C

- Industry standard outline
- RoHS compliant
- Easy to mount with two screws
- Base plate: Copper internally DCB isolated
- Advanced power cycling

| Rectifier | | | | Ratings | | | |
|------------|--|--|---|-----------------------------|------|------|-------------------|
| Symbol | Definition | Conditions | | min. | typ. | max. | Unit |
| V_{RSM} | max. non-repetitive reverse blocking voltage | | | | | 900 | V |
| V_{RRM} | max. repetitive reverse blocking voltage | | | | | 800 | V |
| I_R | reverse current | $V_R = 800$ V | $T_{VJ} = 25^\circ\text{C}$ | | | 100 | μA |
| | | $V_R = 800$ V | $T_{VJ} = 150^\circ\text{C}$ | | | 2 | mA |
| V_F | forward voltage drop | $I_F = 40$ A | $T_{VJ} = 25^\circ\text{C}$ | | | 1.09 | V |
| | | $I_F = 80$ A | | | | 1.24 | V |
| | | $I_F = 40$ A | $T_{VJ} = 125^\circ\text{C}$ | | | 1.00 | V |
| | | $I_F = 80$ A | | | | 1.19 | V |
| I_{DAV} | bridge output current | $T_C = 100^\circ\text{C}$ rectangular | $T_{VJ} = 150^\circ\text{C}$ d = 0.5 | | | 100 | A |
| V_{FO} | threshold voltage | } for power loss calculation only | | | | 0.78 | V |
| r_F | slope resistance | | | | | 4.8 | m Ω |
| R_{thJC} | thermal resistance junction to case | | | | | 0.8 | K/W |
| R_{thCH} | thermal resistance case to heatsink | | | | 0.30 | | K/W |
| P_{tot} | total power dissipation | | | $T_C = 25^\circ\text{C}$ | | 155 | W |
| I_{FSM} | max. forward surge current | t = 10 ms; (50 Hz), sine | $T_{VJ} = 45^\circ\text{C}$ | | | 1.50 | kA |
| | | t = 8,3 ms; (60 Hz), sine | $V_R = 0$ V | | | 1.62 | kA |
| | | t = 10 ms; (50 Hz), sine | $T_{VJ} = 150^\circ\text{C}$ | | | 1.28 | kA |
| | | t = 8,3 ms; (60 Hz), sine | $V_R = 0$ V | | | 1.38 | kA |
| I^2t | value for fusing | t = 10 ms; (50 Hz), sine | $T_{VJ} = 45^\circ\text{C}$ | | | 11.3 | kA ² s |
| | | t = 8,3 ms; (60 Hz), sine | $V_R = 0$ V | | | 10.9 | kA ² s |
| | | t = 10 ms; (50 Hz), sine | $T_{VJ} = 150^\circ\text{C}$ | | | 8.13 | kA ² s |
| | | t = 8,3 ms; (60 Hz), sine | $V_R = 0$ V | | | 7.87 | kA ² s |
| C_J | junction capacitance | $V_R = 400$ V; f = 1 MHz | | $T_{VJ} = 25^\circ\text{C}$ | | 58 | pF |

| Package PWS-C | | | Ratings | | | |
|---------------|--|----------------------|---------|------|------|------|
| Symbol | Definition | Conditions | min. | typ. | max. | Unit |
| I_{RMS} | RMS current | per terminal | | | 150 | A |
| T_{stg} | storage temperature | | -40 | | 125 | °C |
| T_{VJ} | virtual junction temperature | | -40 | | 150 | °C |
| Weight | | | | 237 | | g |
| M_D | mounting torque | | 4.25 | | 5.75 | Nm |
| M_T | terminal torque | | 4.25 | | 5.75 | Nm |
| $d_{Spp/App}$ | creepage distance on surface striking distance through air | terminal to terminal | 26.0 | | | mm |
| $d_{Spb/Apb}$ | | terminal to backside | 14.0 | | | mm |
| V_{ISOL} | isolation voltage | t = 1 second | 3000 | | | V |
| | | t = 1 minute | 2500 | | | V |

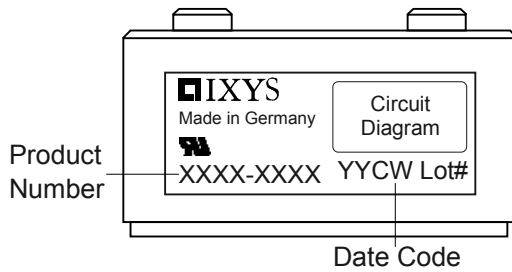

| Ordering | Part Number | Marking on Product | Delivery Mode | Quantity | Code No. |
|----------|--------------|--------------------|---------------|----------|----------|
| Standard | VBO105-08NO7 | VBO105-08NO7 | Box | 10 | 475769 |

Equivalent Circuits for Simulation

* on die level

$T_{VJ} = 150\text{ °C}$

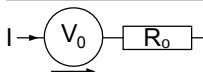

Rectifier

| | | | |
|--------------|--------------------|------|----|
| $V_{0\ max}$ | threshold voltage | 0.78 | V |
| $R_{0\ max}$ | slope resistance * | 3.6 | mΩ |

Outlines PWS-C

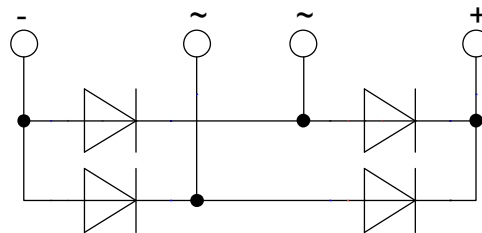
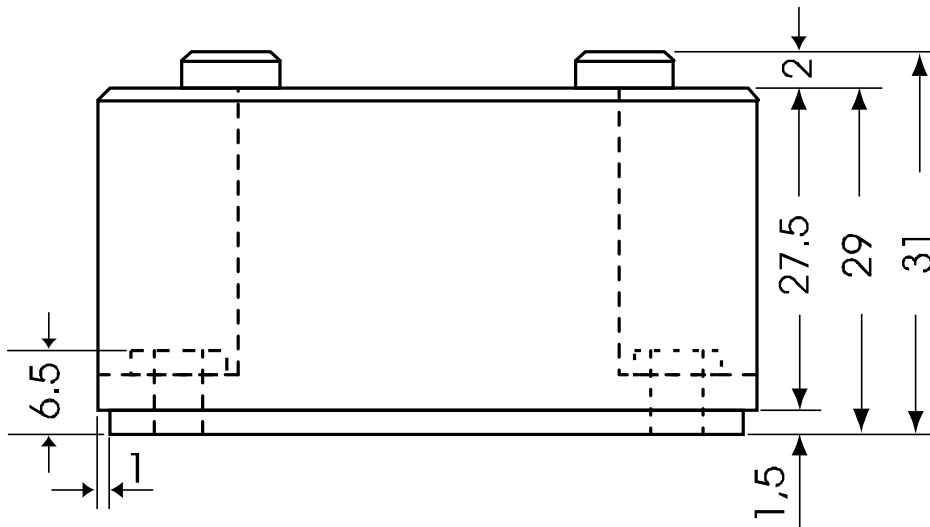
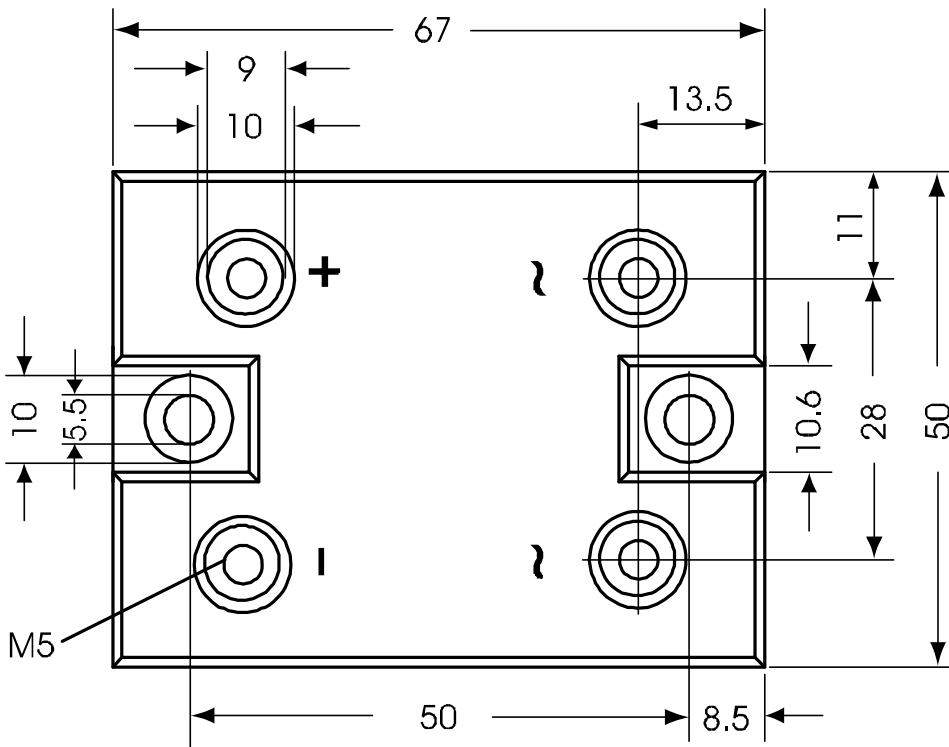

Rectifier

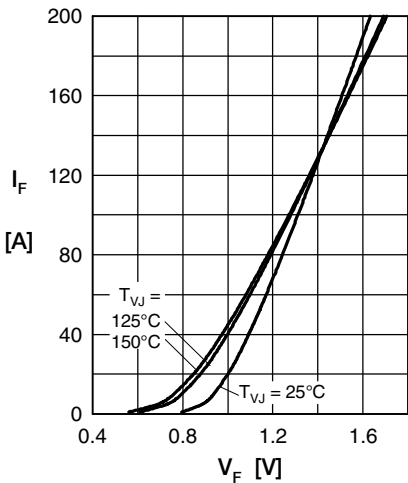

Fig. 1 Forward current versus voltage drop per diode

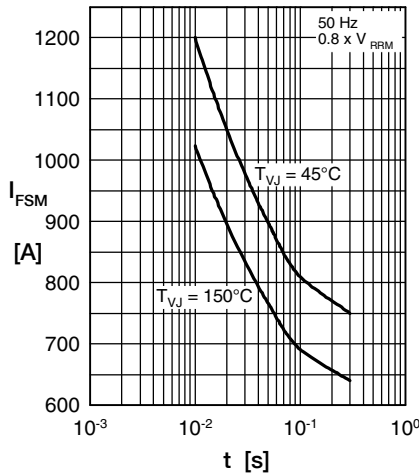

Fig. 2 Surge overload current vs. time per diode

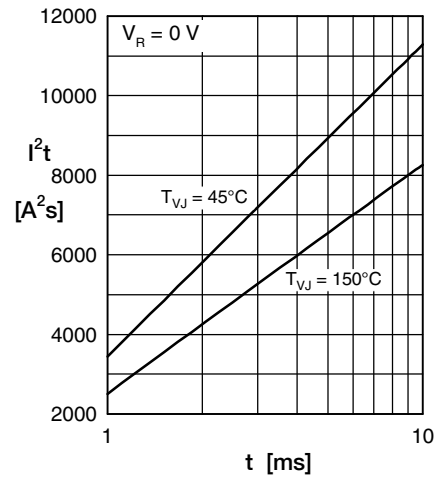

Fig. 3 I^2t versus time per diode

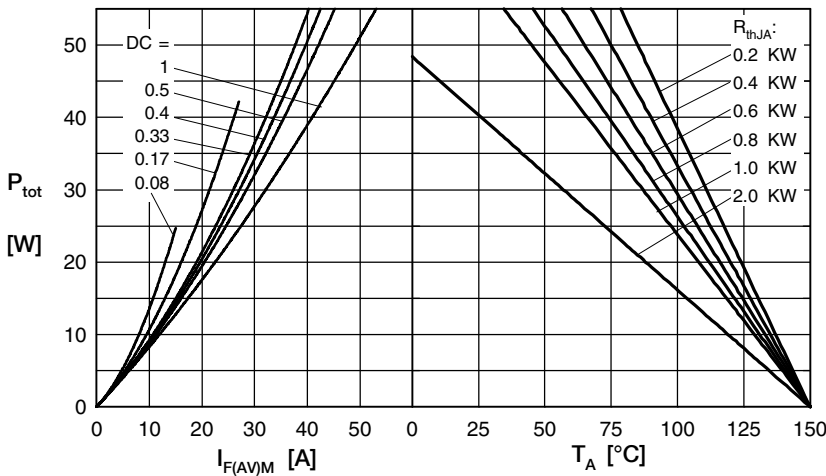

Fig. 4 Power dissipation vs. forward current and ambient temperature per diode

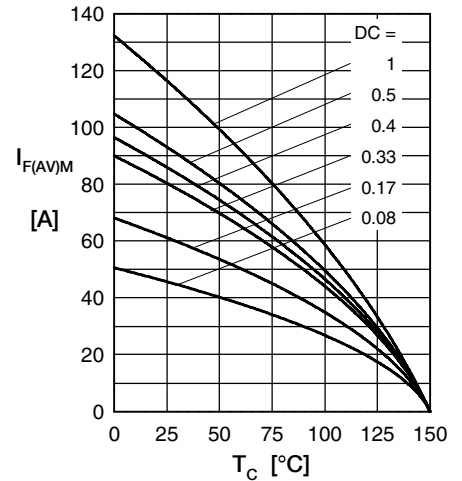

Fig. 5 Max. forward current vs. case temperature per diode

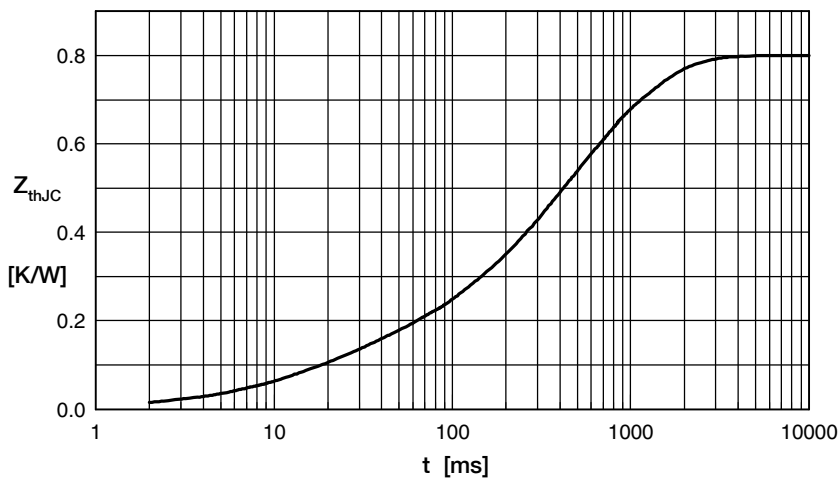

Fig. 6 Transient thermal impedance junction to case vs. time per diode

Constants for Z_{thJC} calculation:

| i | R_{th} (K/W) | t_i (s) |
|---|----------------|-----------|
| 1 | 0.100 | 0.020 |
| 2 | 0.014 | 0.010 |
| 3 | 0.192 | 0.225 |
| 4 | 0.281 | 0.800 |
| 5 | 0.213 | 0.580 |