

High temperature 16 A Snubberless™ Triacs

Datasheet - production data

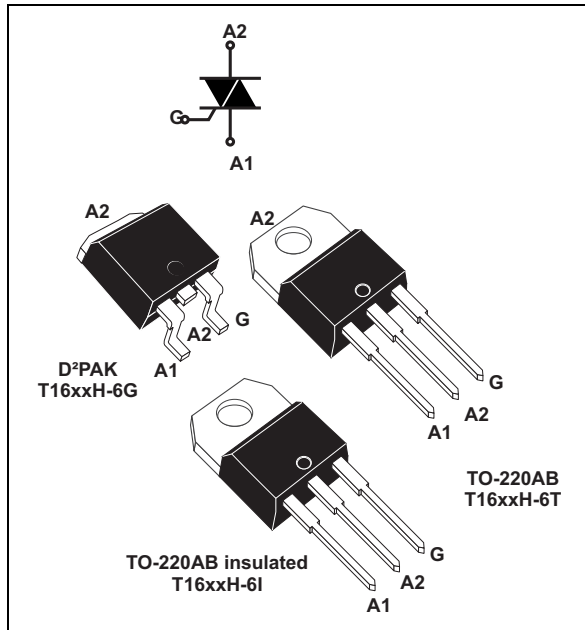

Applications

Especially designed to operate in high power density or universal motor applications such as vacuum cleaner and washing machine drum motor, these 16 A Triacs provide a very high switching capability up to junction temperatures of 150 °C.

The heatsink can be reduced, compared to traditional Triacs, according to the high performance at given junction temperatures.

Description

Available in through-hole or surface mount packages, the T1635H and T1650H Triac series are suitable for general purpose mains power ac switching.

By using an internal ceramic pad, the T16xxH-6I provides voltage insulation (rated at 2500 V rms).

Features

- Medium current Triac
- 150 °C max. T_j turn-off commutation
- Low thermal resistance with clip bonding
- Very high 3 quadrants commutation capability
- Packages are RoHS (2002/95/EC) compliant
- UL certified (ref. file E81734)

Table 1. Device summary

Symbol	Value	Unit
$I_{T(RMS)}$	16	A
V_{DRM}/V_{RRM}	600	V
I_{GT}	35 or 50	mA

™: Snubberless is a trademark of STMicroelectronics

1 Characteristics

Table 2. Absolute maximum ratings

Symbol	Parameter		Value	Unit	
$I_{T(RMS)}$	On-state rms current (full sine wave)	D ² PAK, TO-220AB	$T_c = 130\text{ °C}$	16	A
		TO-220AB Ins	$T_c = 113\text{ °C}$		
I_{TSM}	Non repetitive surge peak on-state current (full cycle, T_j initial = 25 °C)	F = 50 Hz	t = 20 ms	160	A
		F = 60 Hz	t = 16.7 ms	168	
I^2t	I^2t Value for fusing	$t_p = 10\text{ ms}$		169	A ² s
dI/dt	Critical rate of rise of on-state current $I_G = 2 \times I_{GT}$, $t_r \leq 100\text{ ns}$	F = 120 Hz	$T_j = 150\text{ °C}$	50	A/ μ s
V_{DSM}/V_{RSM}	Non repetitive surge peak off-state voltage	$t_p = 10\text{ ms}$	$T_j = 25\text{ °C}$	$V_{DRM}/V_{RRM} + 100$	V
I_{GM}	Peak gate current	$t_p = 20\text{ }\mu\text{s}$	$T_j = 150\text{ °C}$	4	A
$P_{G(AV)}$	Average gate power dissipation		$T_j = 150\text{ °C}$	1	W
T_{stg} T_j	Storage junction temperature range Operating junction temperature range			- 40 to + 150 - 40 to + 150	°C

Table 3. Electrical characteristics ($T_j = 25\text{ °C}$, unless otherwise specified)

Symbol	Test conditions	Quadrant		Value		Unit
				T1635H	T1650H	
$I_{GT}^{(1)}$	$V_D = 12\text{ V}$, $R_L = 33\text{ }\Omega$	I - II - III	MAX.	35	50	mA
V_{GT}		I - II - III	MAX.	1.0		V
V_{GD}	$V_D = V_{DRM}$, $R_L = 3.3\text{ k}\Omega$	I - II - III	MIN.	0.15		V
$I_H^{(2)}$	$I_T = 500\text{ mA}$		MAX.	35	75	mA
I_L	$I_G = 1.2 I_{GT}$	I - III	MAX.	50	90	mA
		II		80	110	
dV/dt ⁽²⁾	$V_D = 67\% V_{DRM}$, gate open, $T_j = 150\text{ °C}$		MIN.	1000	1500	V/ μ s
(dI/dt) _c ⁽²⁾	Without snubber, $T_j = 150\text{ °C}$		MIN.	21	28	A/ms

1. minimum I_{GT} is guaranteed at 20% of I_{GT} max.
2. for both polarities of A2 referenced to A1.

Table 4. Static characteristics

Symbol	Test conditions			Value	Unit
$V_T^{(1)}$	$I_{TM} = 23 \text{ A}$, $t_p = 380 \mu\text{s}$	$T_j = 25 \text{ }^\circ\text{C}$	MAX.	1.5	V
$V_{T0}^{(1)}$	Threshold voltage	$T_j = 150 \text{ }^\circ\text{C}$	MAX.	0.80	V
$R_d^{(1)}$	Dynamic resistance	$T_j = 150 \text{ }^\circ\text{C}$	MAX.	23	m Ω
I_{DRM} $I_{RRM}^{(2)}$	$V_{DRM} = V_{RRM}$	$T_j = 25 \text{ }^\circ\text{C}$	MAX.	5	μA
		$T_j = 150 \text{ }^\circ\text{C}$	MAX.	4.1	mA
	$V_D/V_R = 400 \text{ V}$ (at peak mains voltage)	$T_j = 150 \text{ }^\circ\text{C}$	MAX.	3.5	
	$V_D/V_R = 200 \text{ V}$ (at peak mains voltage)	$T_j = 150 \text{ }^\circ\text{C}$	MAX.	3.0	

1. for both polarities of A2 referenced to A1

2. $t_p = 380 \mu\text{s}$.

Table 5. Thermal resistance

Symbol	Parameter		Value	Unit	
$R_{th(j-c)}$	Junction to case (AC)	D ² PAK / TO-220AB	1.15	$^\circ\text{C/W}$	
		TO-220AB Ins	2.1		
$R_{th(j-a)}$	Junction to ambient	S = 1 cm ²	D ² PAK		45
			TO-220AB / TO-220AB Ins		60

Figure 1. Maximum power dissipation versus on-state rms current (full cycle)

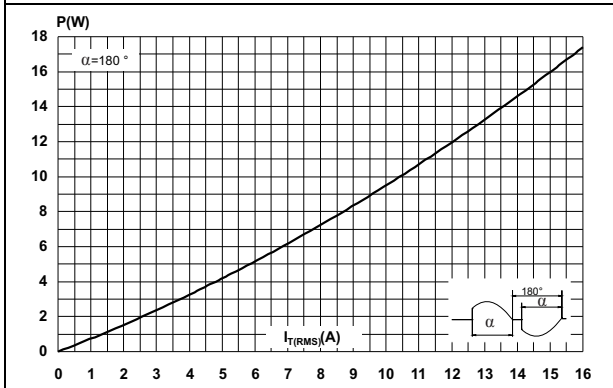

Figure 2. On-state rms current versus case temperature (full cycle)

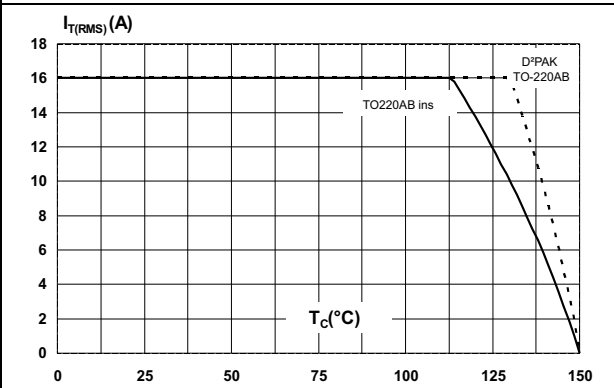

Figure 3. On-state rms current versus ambient temperature

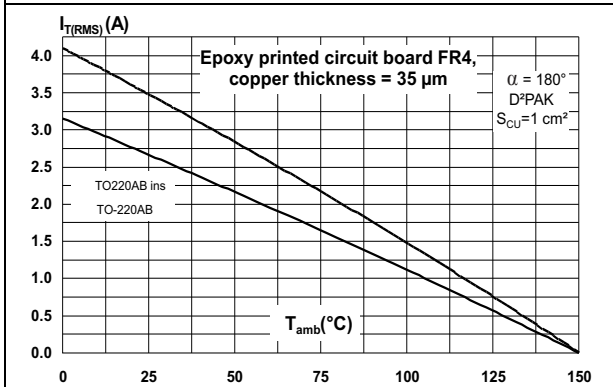

Figure 4. Relative variation of thermal impedance versus pulse duration

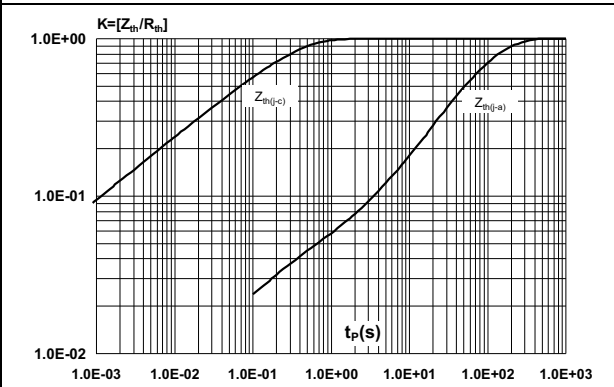

Figure 5. On-state characteristics (maximum values)

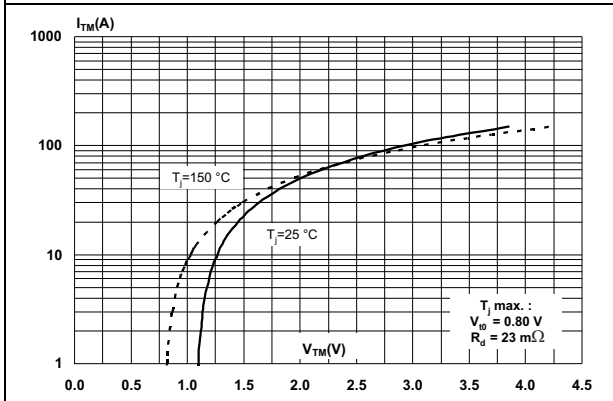

Figure 6. Surge peak on-state current versus number of cycles

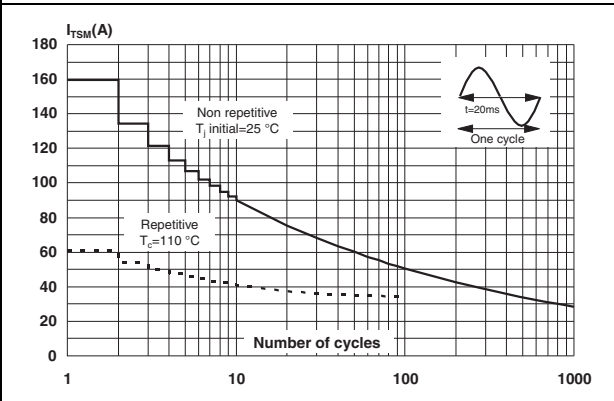

Figure 7. Non-repetitive surge peak on-state current for a sinusoidal pulse

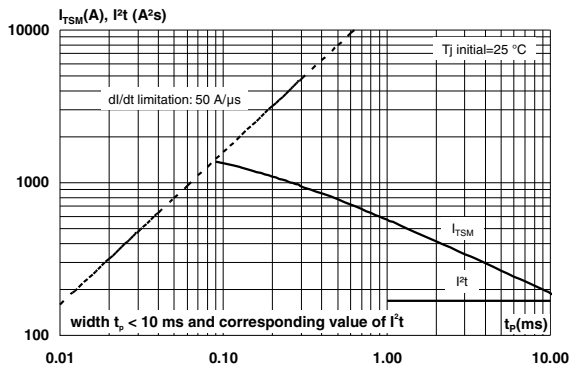

Figure 8. Relative variation of I_{GT}, I_H, I_L vs junction temperature (typical values)

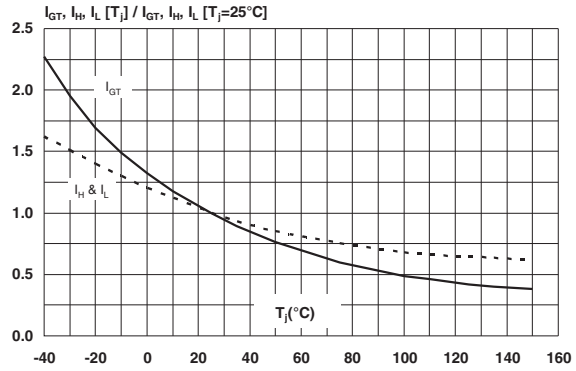

Figure 9. Relative variation of critical rate of decrease of main current $(dI/dt)_c$ versus reappplied $(dV/dt)_c$

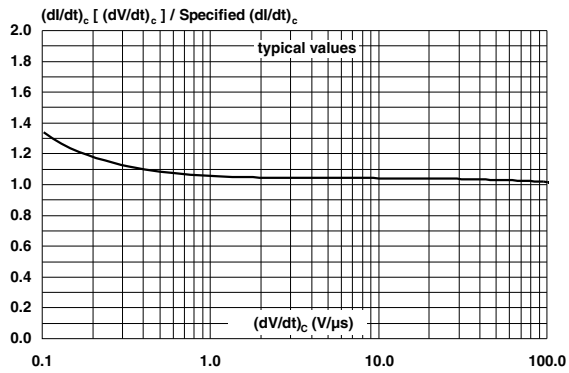

Figure 10. Relative variation of critical rate of decrease of main current versus junction temperature

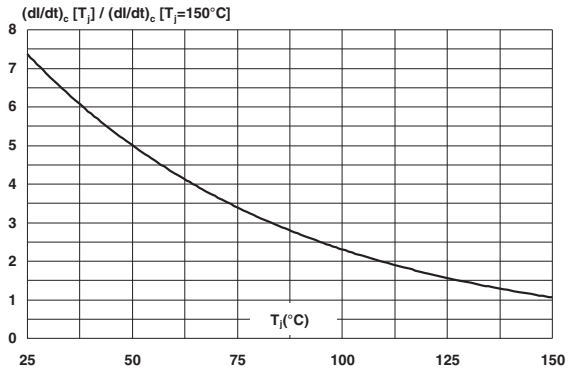

Figure 11. Leakage current versus junction temperature for different values of blocking voltage (typical values)

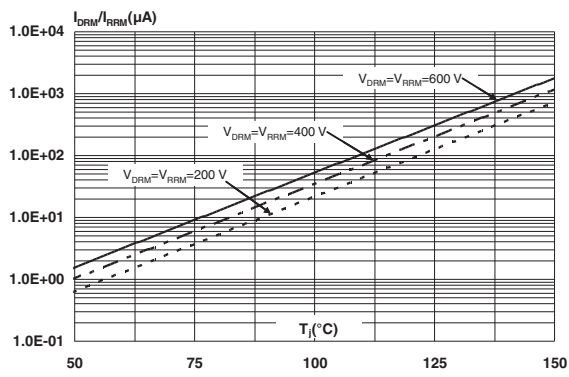
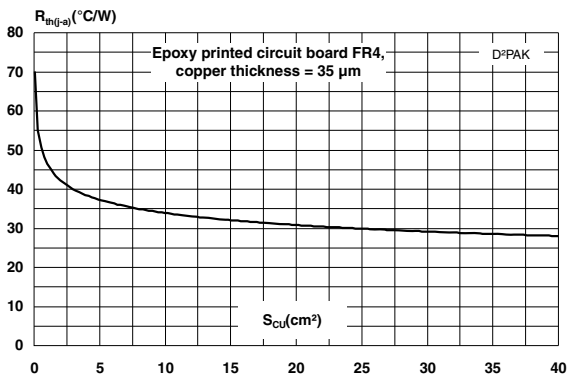

Figure 12. Variation of thermal resistance junction to ambient versus copper surface under tab



2 Package information

- Epoxy meets UL94, V0
- Lead-free package
- Recommended torque: 0.4 to 0.6 N·m

In order to meet environmental requirements, ST offers these devices in different grades of ECOPACK[®] packages, depending on their level of environmental compliance. ECOPACK[®] specifications, grade definitions and product status are available at: www.st.com. ECOPACK[®] is an ST trademark.

Figure 13. TO-220AB dimension definitions

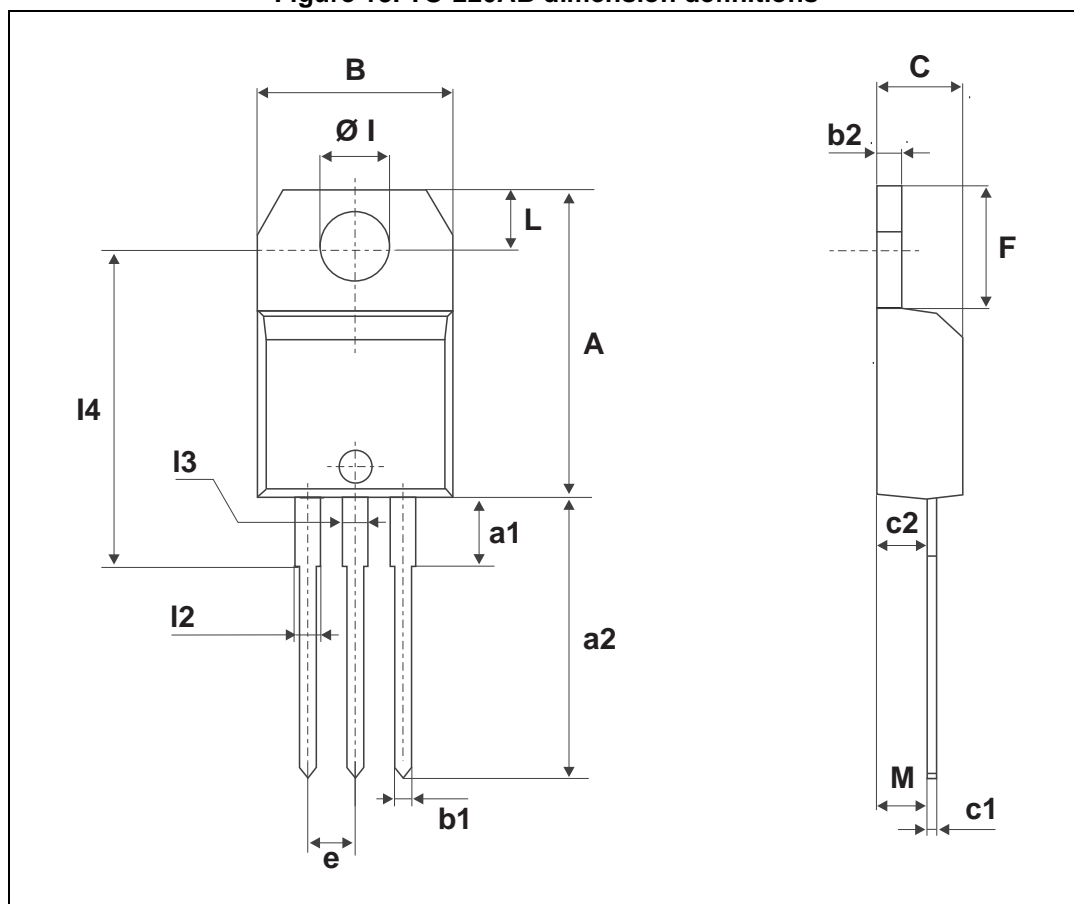

Table 6. TO-220AB dimension values

Ref.	Dimensions					
	Millimeters			Inches		
	Min.	Typ.	Max.	Min.	Typ.	Max.
A	15.20		15.90	0.598		0.625
a1		3.75			0.147	
a2	13.00		14.00	0.511		0.551
B	10.00		10.40	0.393		0.409
b1	0.61		0.88	0.024		0.034
b2	1.23		1.32	0.048		0.051
C	4.40		4.60	0.173		0.181
c1	0.49		0.70	0.019		0.027
c2	2.40		2.72	0.094		0.107
e	2.40		2.70	0.094		0.106
F	6.20		6.60	0.244		0.259
ØI	3.75		3.85	0.147		0.151
I4	15.80	16.40	16.80	0.622	0.646	0.661
L	2.65		2.95	0.104		0.116
I2	1.14		1.70	0.044		0.066
I3	1.14		1.70	0.044		0.066
M		2.60			0.102	

Figure 14. D²PAK dimension definitions

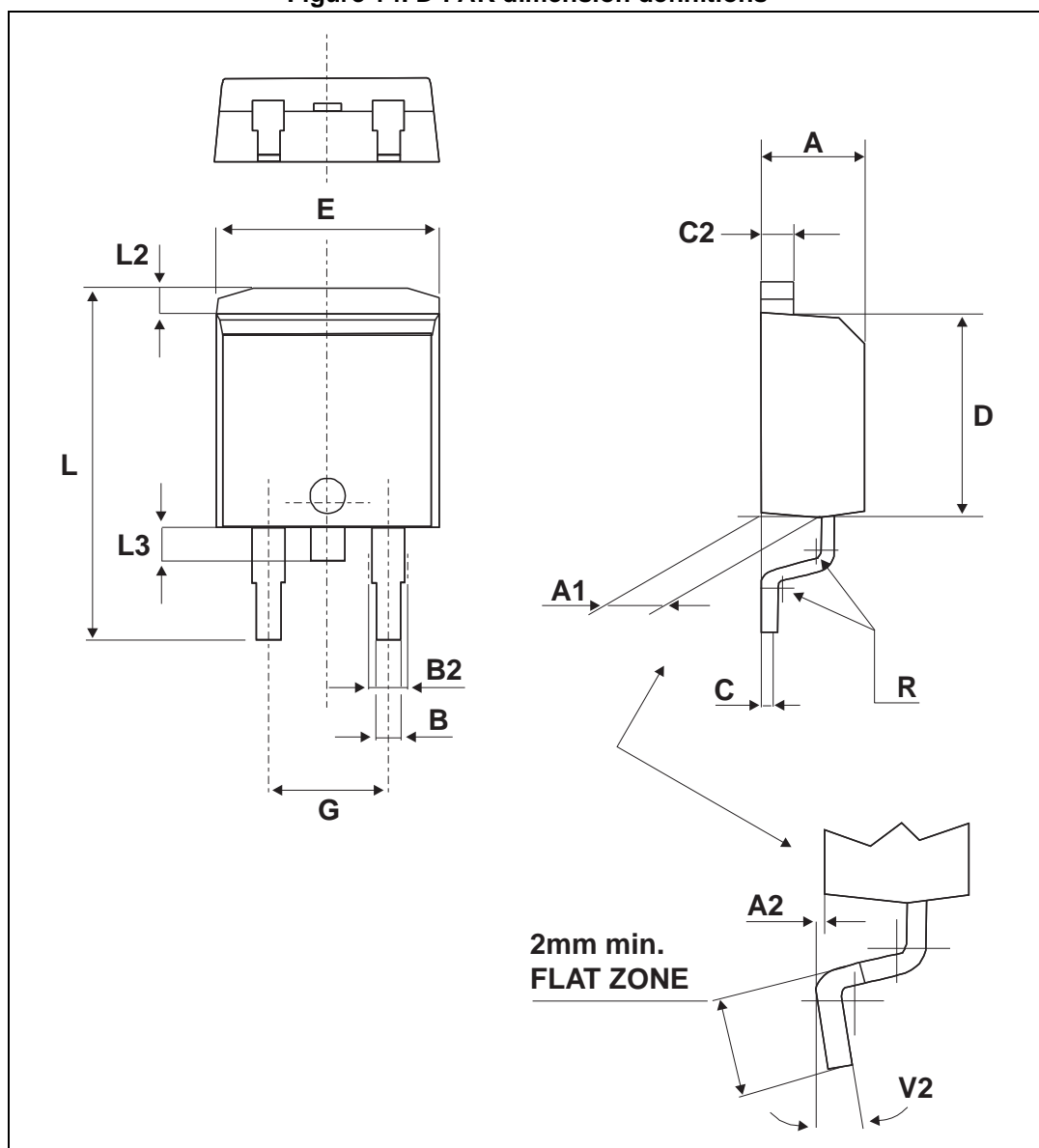
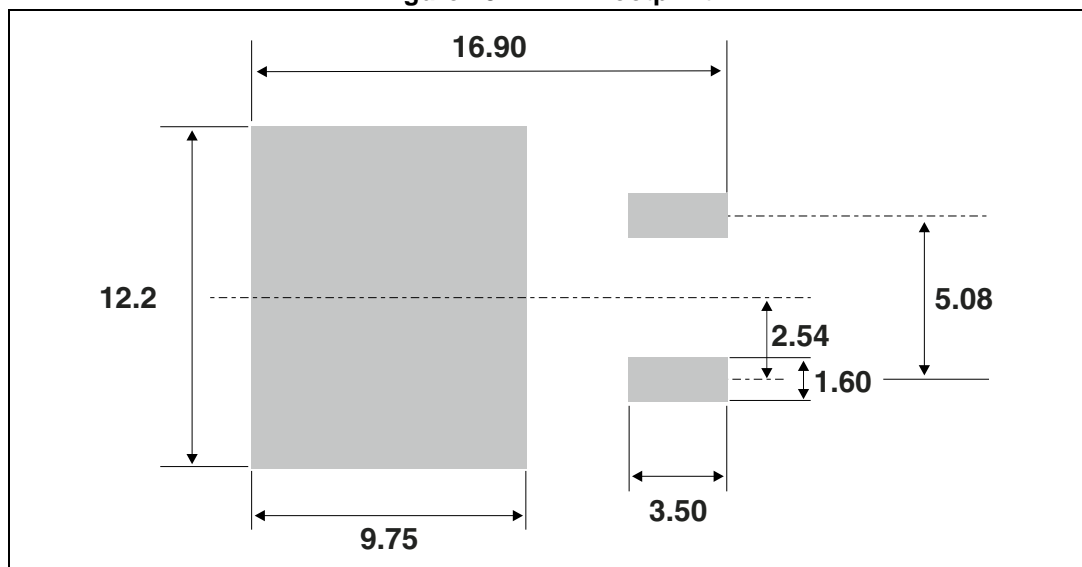

Table 7. D²PAK dimension values

Ref.	Dimensions					
	Millimeters			Inches		
	Min.	Typ.	Max.	Min.	Typ.	Max.
A	4.30		4.60	0.169		0.181
A1	2.49		2.69	0.098		0.106
A2	0.03		0.23	0.001		0.009
B	0.70		0.93	0.027		0.037
B2	1.25	1.40		0.048	0.055	
C	0.45		0.60	0.017		0.024
C2	1.21		1.36	0.047		0.054
D	8.95		9.35	0.352		0.368
E	10.00		10.28	0.393		0.405
G	4.88		5.28	0.192		0.208
L	15.00		15.85	0.590		0.624
L2	1.27		1.40	0.050		0.055
L3	1.40		1.75	0.055		0.069
R	0.40			0.016		
V2	0°		8°	0°		8°

Figure 15. D²PAK footprint

3 Ordering information

Figure 16. Ordering information scheme

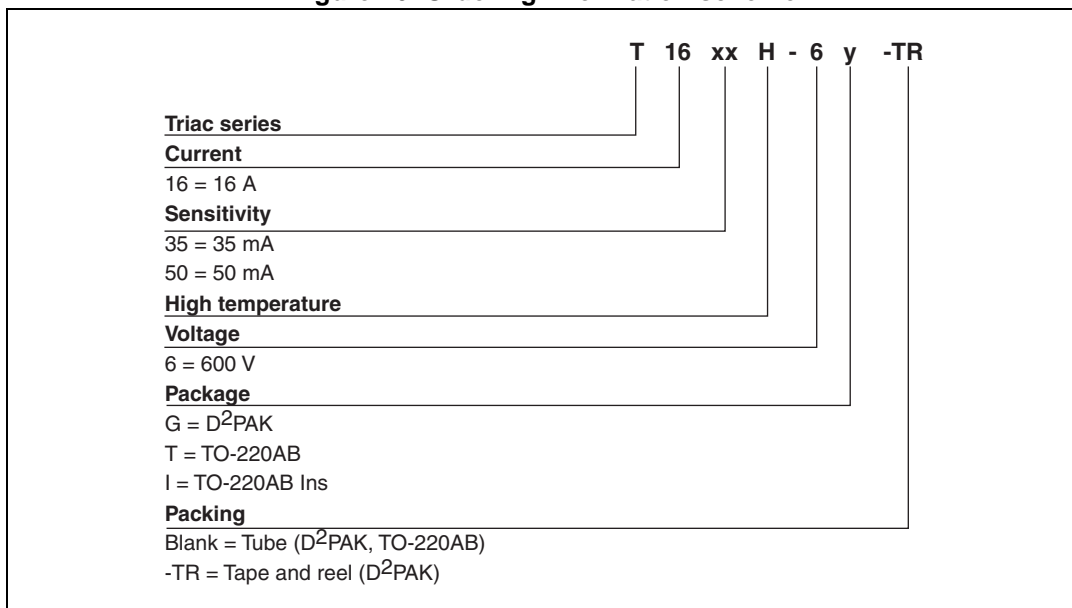

Table 8. Ordering information

Order code	Marking	Package	Weight	Base qty	Delivery mode
T16xxH-6G	T16xxH 6G	D ² PAK	1.5 g	50	Tube
T16xxH-6G-TR	T16xxH 6G	D ² PAK	1.5 g	1000	Tape and reel
T16xxH-6T	T16xxH 6T	TO-220AB	2.3 g	50	Tube
T16xxH-6I	T16xxH 6I	TO-220AB Ins	2.3 g	50	Tube

4 Revision history

Table 9. Document revision history

Date	Revision	Changes
29-May-2007	1	First issue.
20-Sep-2011	2	Updated: Features , Description and Figure 2 .
31-Jan-2014	3	Updated Figure 2 , Figure 3 , Figure 4 , Table 2 and Table 5 .

Please Read Carefully:

Information in this document is provided solely in connection with ST products. STMicroelectronics NV and its subsidiaries ("ST") reserve the right to make changes, corrections, modifications or improvements, to this document, and the products and services described herein at any time, without notice.

All ST products are sold pursuant to ST's terms and conditions of sale.

Purchasers are solely responsible for the choice, selection and use of the ST products and services described herein, and ST assumes no liability whatsoever relating to the choice, selection or use of the ST products and services described herein.

No license, express or implied, by estoppel or otherwise, to any intellectual property rights is granted under this document. If any part of this document refers to any third party products or services it shall not be deemed a license grant by ST for the use of such third party products or services, or any intellectual property contained therein or considered as a warranty covering the use in any manner whatsoever of such third party products or services or any intellectual property contained therein.

UNLESS OTHERWISE SET FORTH IN ST'S TERMS AND CONDITIONS OF SALE ST DISCLAIMS ANY EXPRESS OR IMPLIED WARRANTY WITH RESPECT TO THE USE AND/OR SALE OF ST PRODUCTS INCLUDING WITHOUT LIMITATION IMPLIED WARRANTIES OF MERCHANTABILITY, FITNESS FOR A PARTICULAR PURPOSE (AND THEIR EQUIVALENTS UNDER THE LAWS OF ANY JURISDICTION), OR INFRINGEMENT OF ANY PATENT, COPYRIGHT OR OTHER INTELLECTUAL PROPERTY RIGHT.

ST PRODUCTS ARE NOT DESIGNED OR AUTHORIZED FOR USE IN: (A) SAFETY CRITICAL APPLICATIONS SUCH AS LIFE SUPPORTING, ACTIVE IMPLANTED DEVICES OR SYSTEMS WITH PRODUCT FUNCTIONAL SAFETY REQUIREMENTS; (B) AERONAUTIC APPLICATIONS; (C) AUTOMOTIVE APPLICATIONS OR ENVIRONMENTS, AND/OR (D) AEROSPACE APPLICATIONS OR ENVIRONMENTS. WHERE ST PRODUCTS ARE NOT DESIGNED FOR SUCH USE, THE PURCHASER SHALL USE PRODUCTS AT PURCHASER'S SOLE RISK, EVEN IF ST HAS BEEN INFORMED IN WRITING OF SUCH USAGE, UNLESS A PRODUCT IS EXPRESSLY DESIGNATED BY ST AS BEING INTENDED FOR "AUTOMOTIVE, AUTOMOTIVE SAFETY OR MEDICAL" INDUSTRY DOMAINS ACCORDING TO ST PRODUCT DESIGN SPECIFICATIONS. PRODUCTS FORMALLY ESCC, QML OR JAN QUALIFIED ARE DEEMED SUITABLE FOR USE IN AEROSPACE BY THE CORRESPONDING GOVERNMENTAL AGENCY.

Resale of ST products with provisions different from the statements and/or technical features set forth in this document shall immediately void any warranty granted by ST for the ST product or service described herein and shall not create or extend in any manner whatsoever, any liability of ST.

ST and the ST logo are trademarks or registered trademarks of ST in various countries.

Information in this document supersedes and replaces all information previously supplied.

The ST logo is a registered trademark of STMicroelectronics. All other names are the property of their respective owners.

© 2014 STMicroelectronics - All rights reserved

STMicroelectronics group of companies

Australia - Belgium - Brazil - Canada - China - Czech Republic - Finland - France - Germany - Hong Kong - India - Israel - Italy - Japan - Malaysia - Malta - Morocco - Philippines - Singapore - Spain - Sweden - Switzerland - United Kingdom - United States of America

www.st.com

