



FXP29.07.0070A

## Specification

<b>Part No.</b>	<b>FXP29.07.0070A</b>
<b>Product Name</b>	2100MHz 3G UMTS/HSPA+ Band Flexible PCB Antenna
<b>Feature</b>	1920-2170MHz Operation Ground Plane Independent 1.5 dBi Peak Gain 12.7*8.4*0.24 mm Tiny dimension IPEX MHFI (U.FL Compatible) RoHS Compliant

# 1. Introduction

The FXP29 is a unique super small monopole ultra-low profile antenna for the 2100MHz 3G UMTS/ HSPA+ application band. The FXP29 antenna has peak gain of 1.5dBi and efficiencies of 45%.

It is made from poly-flexible material, has a tiny form factor (12.7mm\*8.4mm\*0.24mm)

and has double-sided 3M tape for easy "peel and stick" mounting onto the inner plastic housing of a device.

It is an ideal solution for compact M2M devices which require 3G functionality at the 2100MHz band.

The cables length and connector are customizable.

The standard length is 70mm and is recommended, some detuning and efficiency decrease is observed on other cable lengths, see chart below for details.

# 2. Specification

## Electrical

<b>Frequency (MHz)</b>	2100MHz UMTS/HSPA 1920~2170
<b>Max Return Loss (dB)</b>	-10
<b>Peak Gain (dBi)</b>	1.5
<b>Efficiency (%)</b>	45
<b>Average Gain (dB)</b>	-3.5
<b>Radiation Properties</b>	Omni-directional
<b>Max Input Power (Watts)</b>	5
<b>Polarization</b>	Linear
<b>Impedance (Ohms)</b>	50 Ohms

## Mechanical

<b>Dimensions (mm)</b>	12.7*8.4*0.24 mm
<b>Material</b>	Flexible Polymer
<b>Connector and Cable</b>	IPEX MHF1 (U.FL) and 1.13 mm mini coax.
<b>Weight (1pc)</b>	0.42g

## Environmental Ratings

<b>Operation Temperature</b>	-40°C to 85°C
<b>Storage Temperature</b>	-40°C to 85°C
<b>Relative Humidity</b>	40% to 95%
<b>RoHs Compliant</b>	Yes

\* All results were measured with 70mm length 1.13mm coaxial cable and on 2mm thickness ABS base.

### 3. Antenna Characteristics

#### 3.1 Return Loss

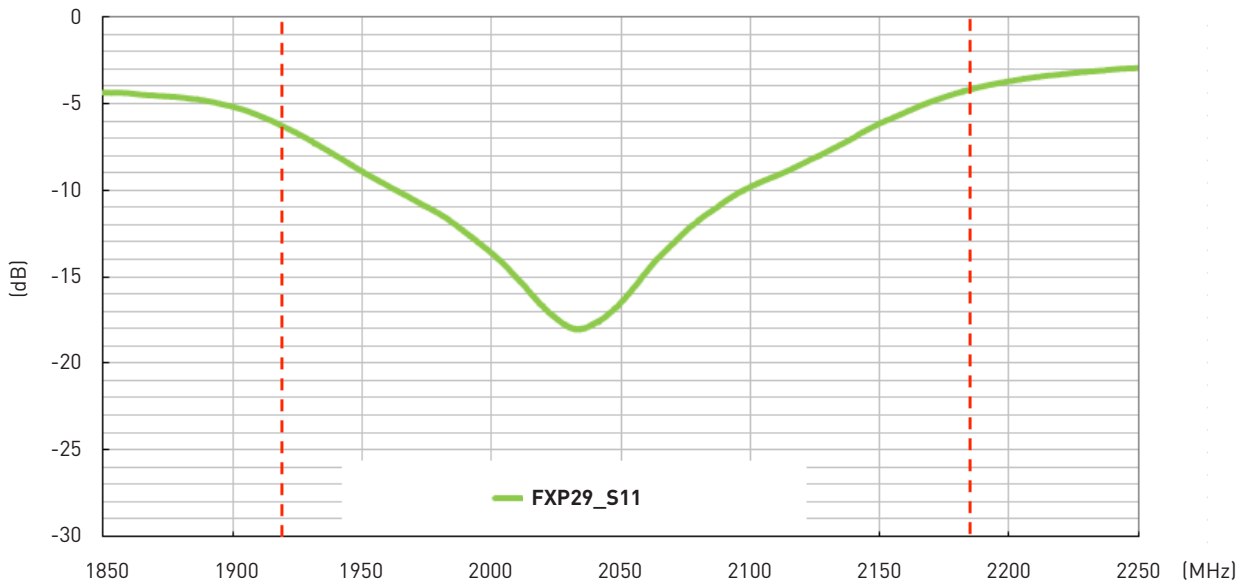

#### 3.2 Peak Gain

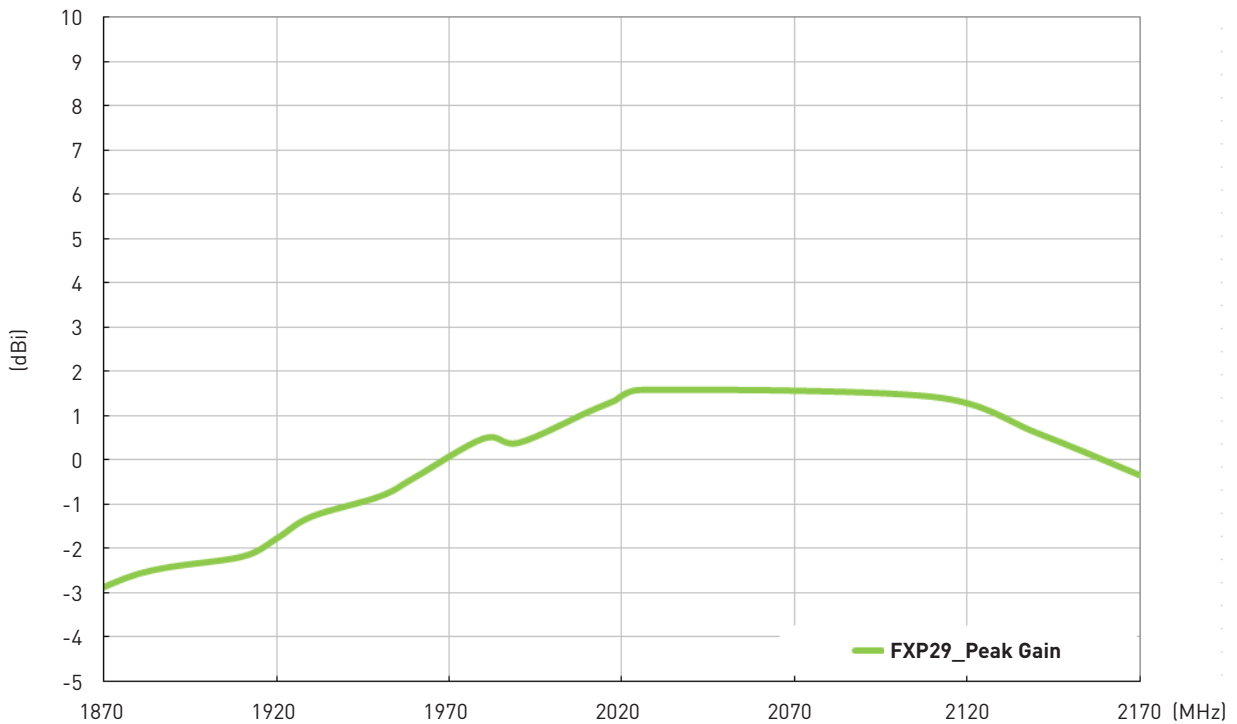

### 3. Antenna Characteristics

#### 3.3 Efficiency

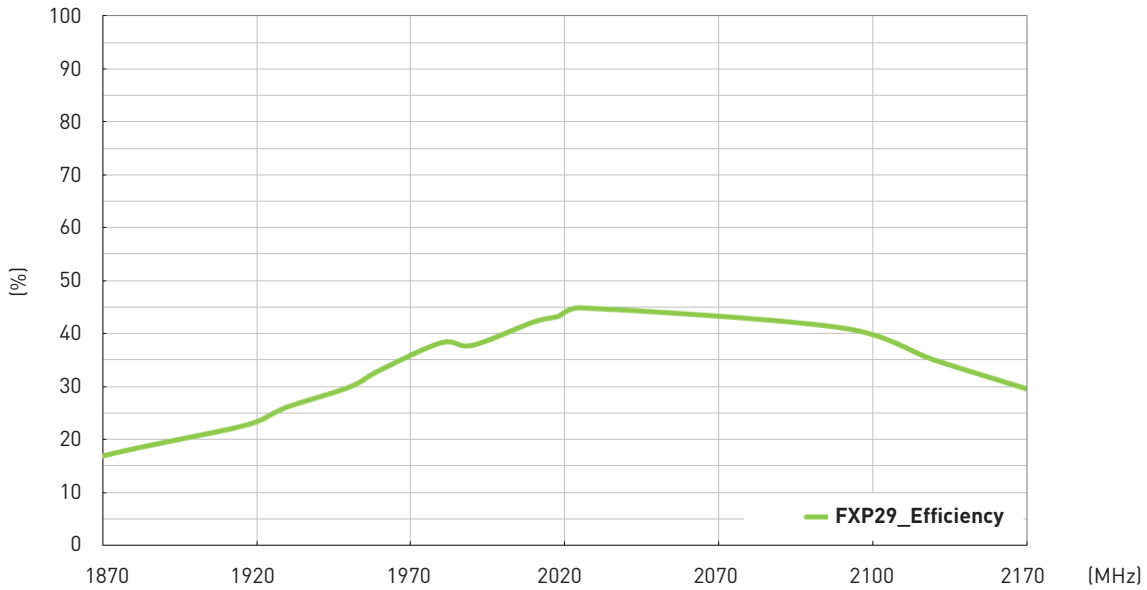

#### 3.4 Average Gain

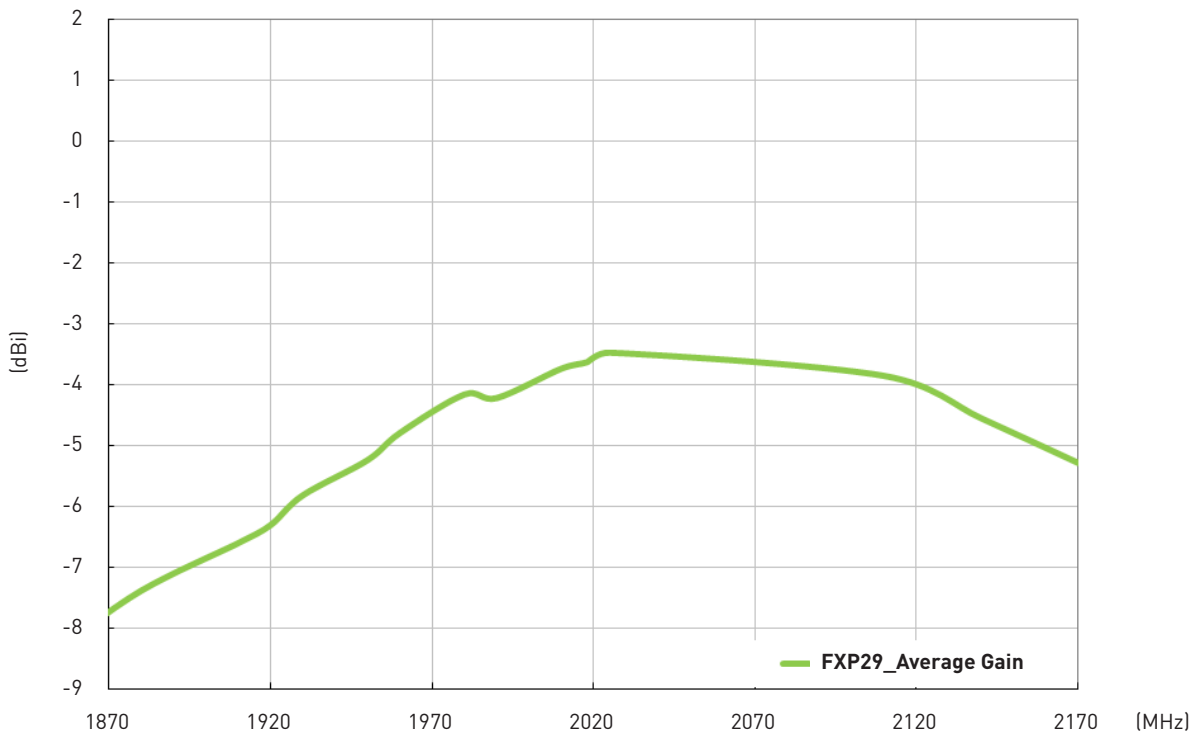

## 4. Antenna Radiation Patterns

### 4.1 Antenna Setup

The antenna radiation pattern measured setup as shown the below,

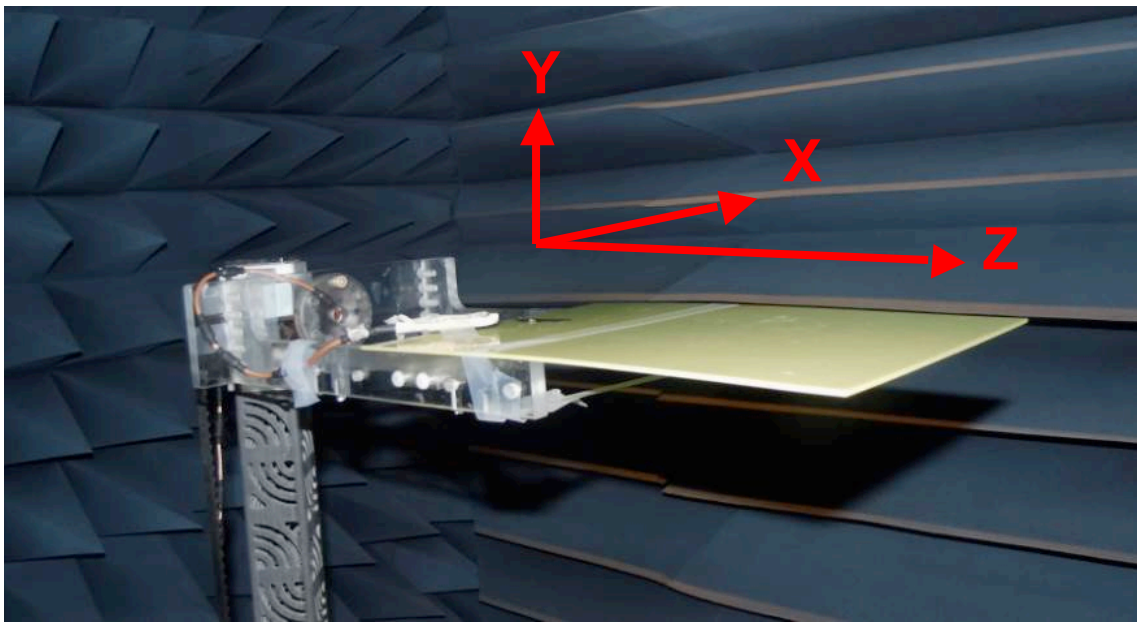

## 4. Antenna Radiation Patterns

### 4.2 Antenna Radiation Patterns

XY - Plane

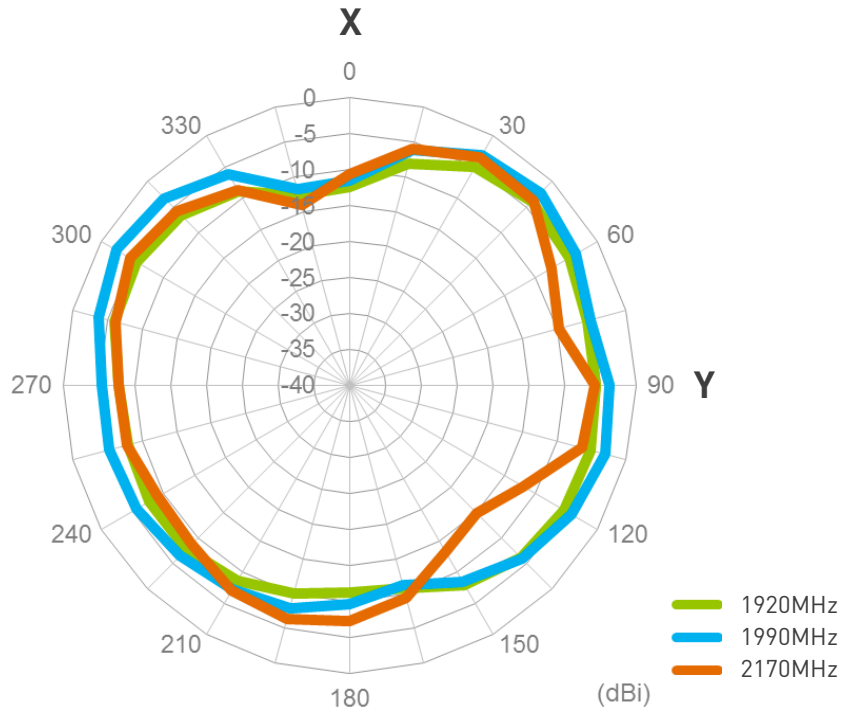

XZ - Plane

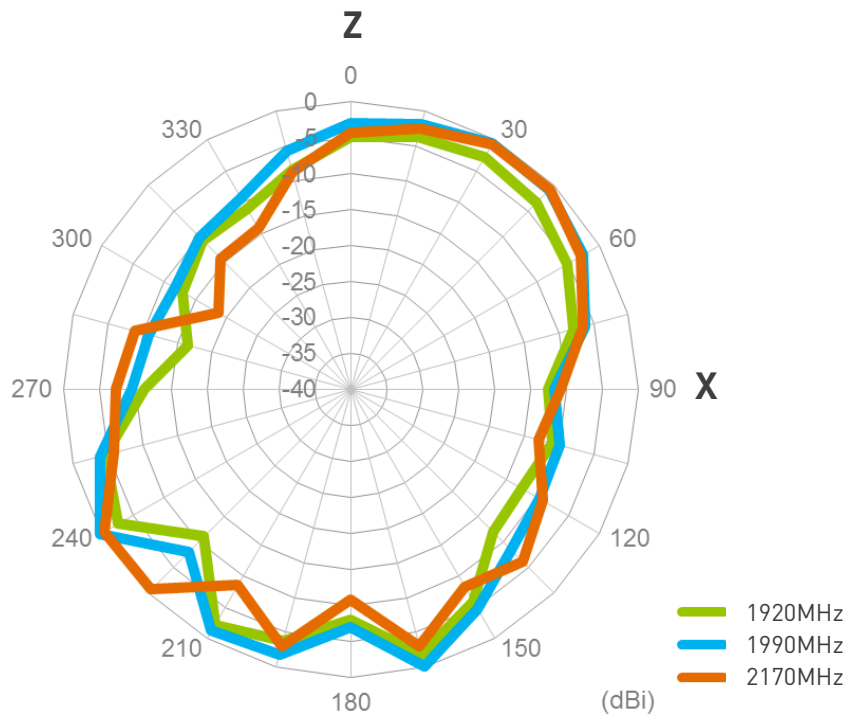

## 4. Antenna Radiation Patterns

### 4.2 Antenna Radiation Patterns

YZ - Plane

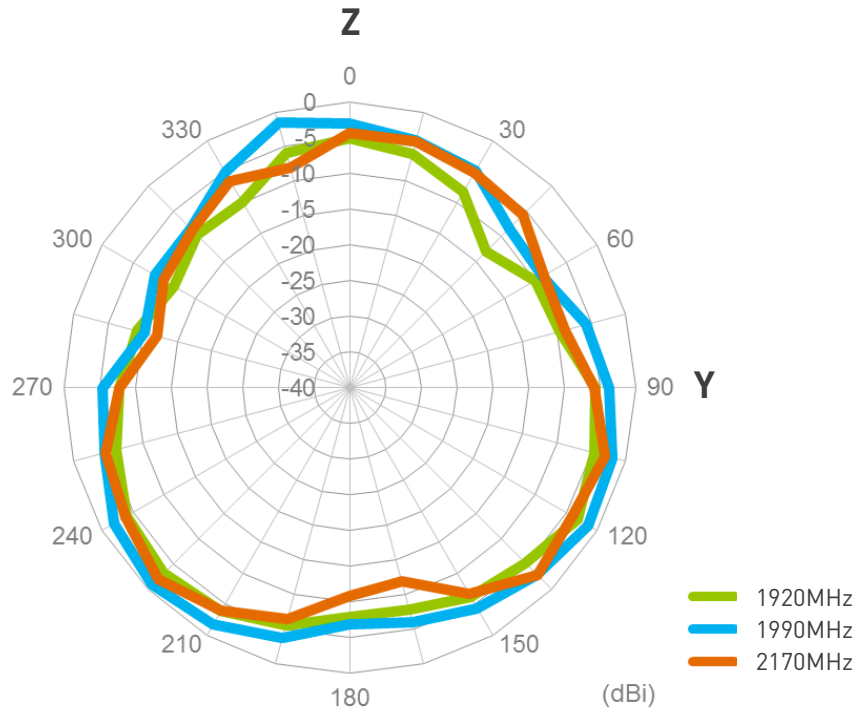

## 5. Drawings

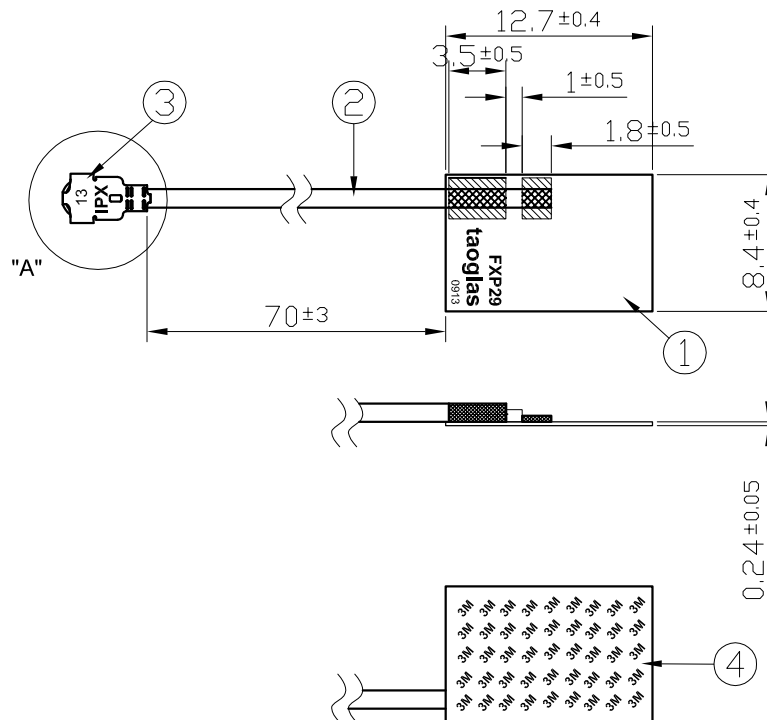
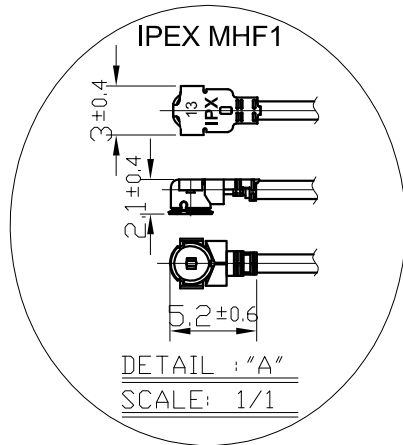

	Name	Material	Finish	QTY
1	FXP29 FPCB	FPCB 0.15t	Black	1
2	1.13 Coaxial Cable	FEP	Black	1
3	IPEX MHF1	Brass	Gold	1
4	Double-Sided Adhesive	3M 467	Brown Liner	1



## 6. Application Note

The FXP.29 antenna measured with difference cable length on plastic plate of 3 mm thickness, the performance is shown as below,

### Return Loss

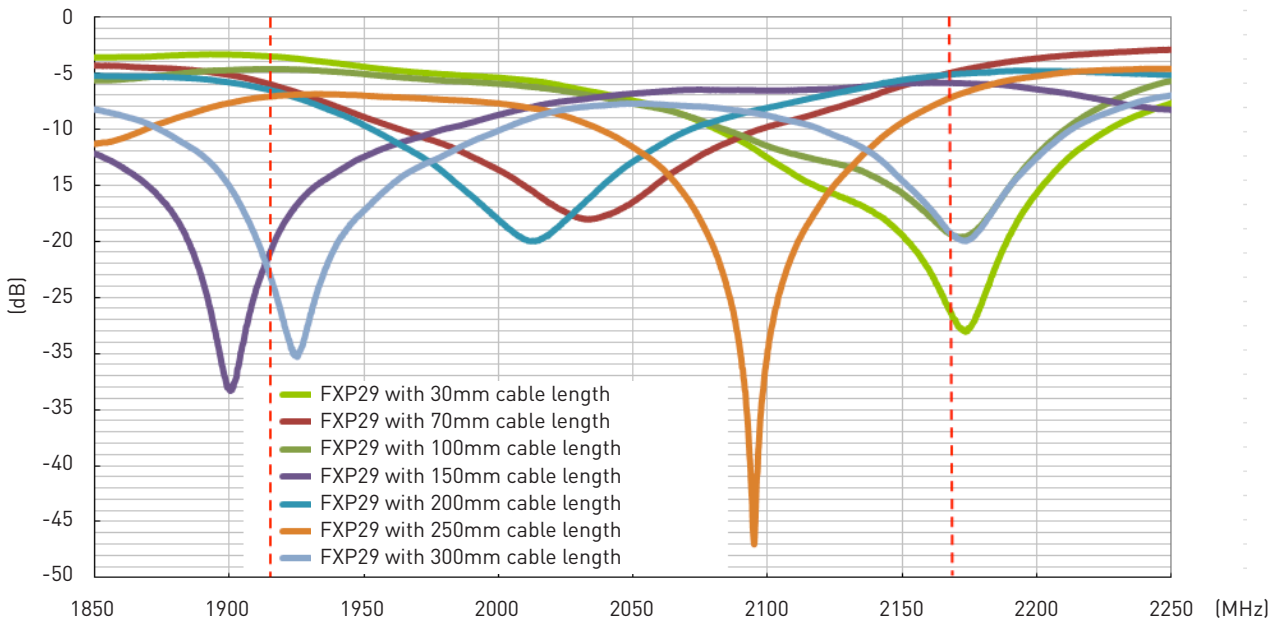

### Efficiency

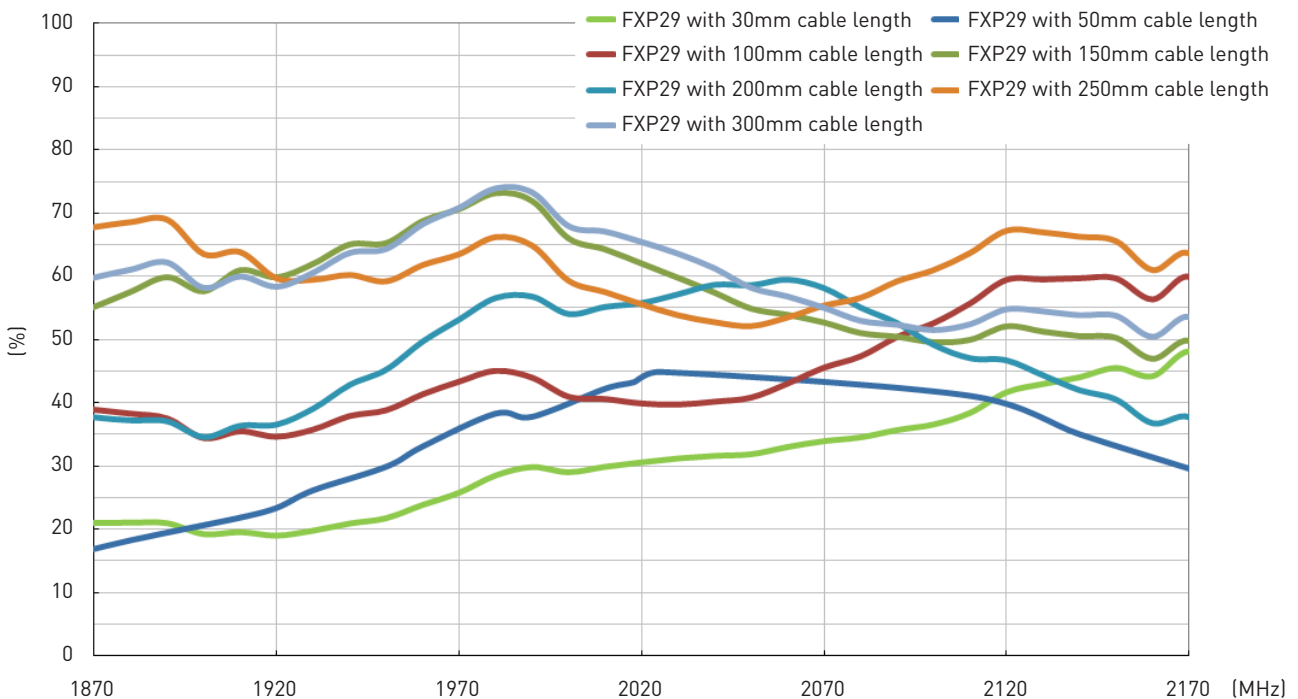

## 6. Application Note

### Average Gain

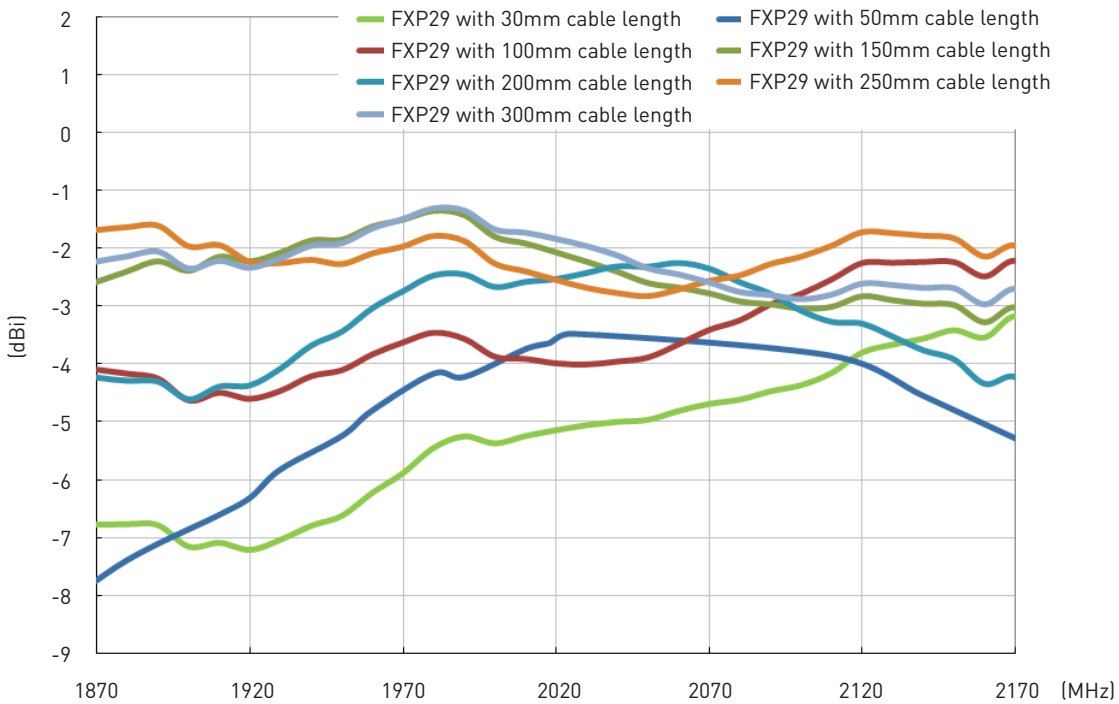

### Peak Gain

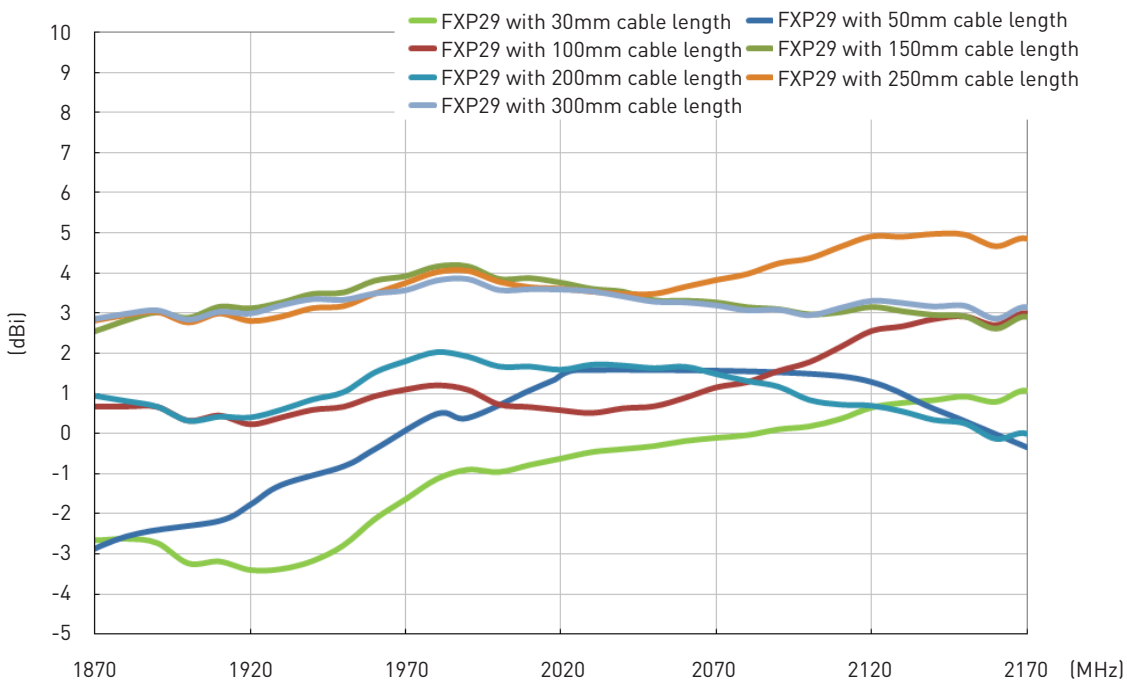

## 7. Packaging

100pcs antenna per small PE bag

Weight 100 pcs: 0.45Kg

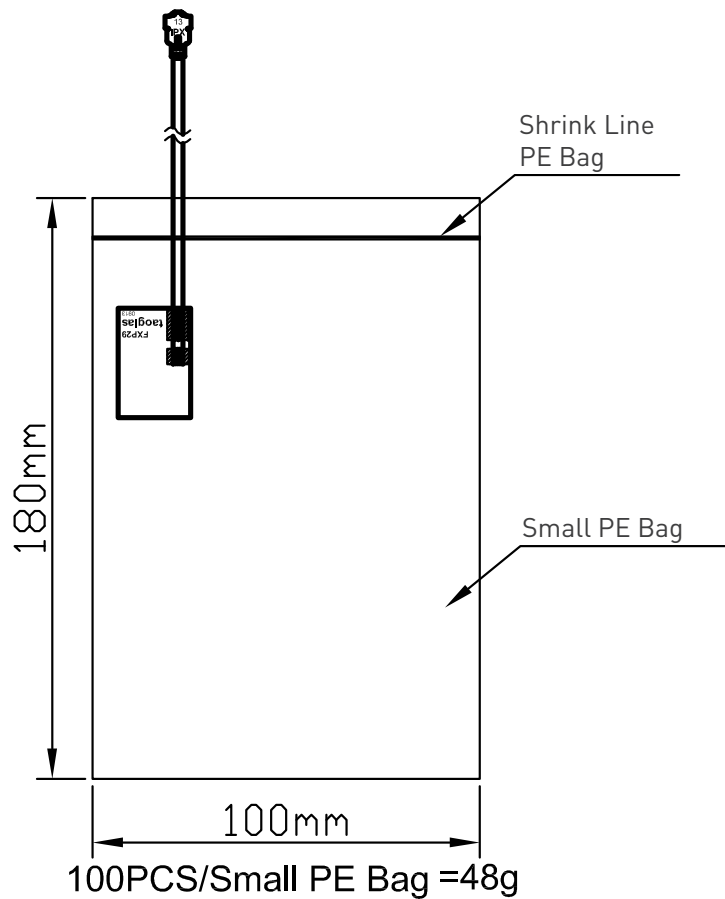

Taoglas makes no warranties based on the accuracy or completeness of the contents of this document and reserves the right to make changes to specifications and

product descriptions at any time without notice. Taoglas reserves all rights to this document and the information contained herein.

Reproduction, use or disclosure to third parties without express permission is strictly prohibited.  
Copyright © Taoglas Ltd.