

DETAILS

Product Number	CA12889_STRADA-SQ-T-DWC
Family	Strada
Type	Assembly
Color	clear
Diameter	25 x 25 mm
Height	8,15 mm
Style	square
Optic Material	PMMA
Holder Material	
Fastening	tape, pin, screw
Status	production ready
ROHS Compliant	Yes
Date Updated	7/10/2014



OPTICAL PROPERTIES

LED	Viewing Angle	Light Beam	Efficiency	cd/lm	Connector
XM-L	Asymmetric deg	Streetligh...	-	-	-
XM-L2	asymmetric deg	Streetligh...	92 %	0.700	-
MK-R	Asymmetric deg	Streetligh...	91 %	0.450	-
MHB-A	sim: Asymmetri	Streetligh...	-	-	-
XHP50	Asymmetric deg	Streetligh...	91 %	0.500	-
LUXEON M/MX	Asymmetric deg	Streetligh...	94 %	0.450	-
LUXEON MZ	asymmetric deg	Streetligh...	91 %	0.700	-
LUXEON XR-M linear 1x3, 1x4, 1x5	Asymmetric deg	Streetligh...	91 %	0.460	-
NS9x383	Asymmetric deg	Streetligh...	91 %	0.660	-
NV4x144A	Asymmetric deg	Streetligh...	90 %	0.470	-
OLP-5065F6L-06A	Asymmetric deg	Streetligh...	91 %	0.530	-
Duris S10	Asymmetric deg	Streetligh...	90 %	0.490	-
Duris P10	sim: Asymmetri	Streetligh...	sim: 87 %	sim: 0.580	-

Absolute intensity of C12726&CA12889_STRADA-SQ-T-DWC (Luxeon M)

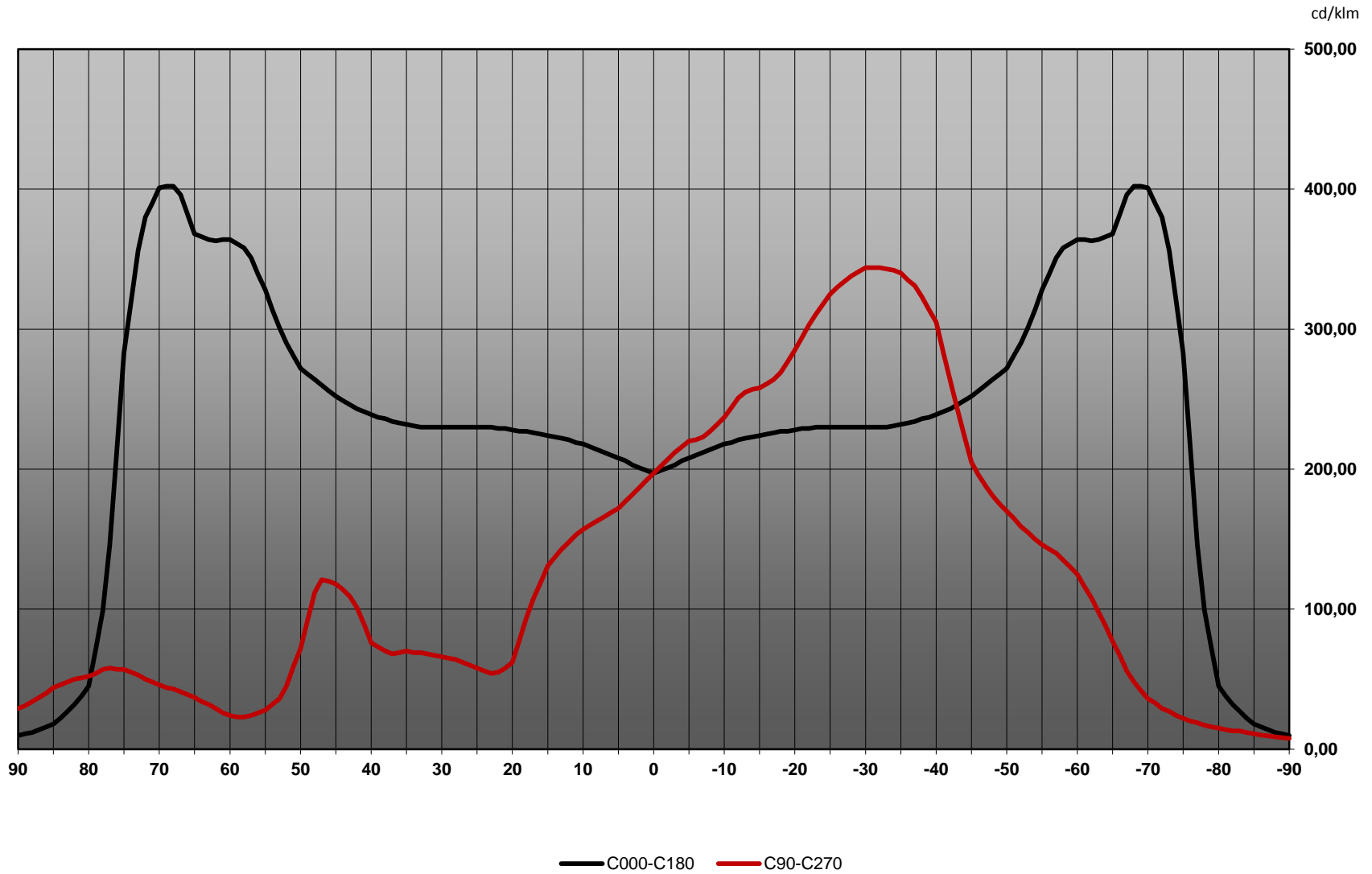

D

C

B

A

4

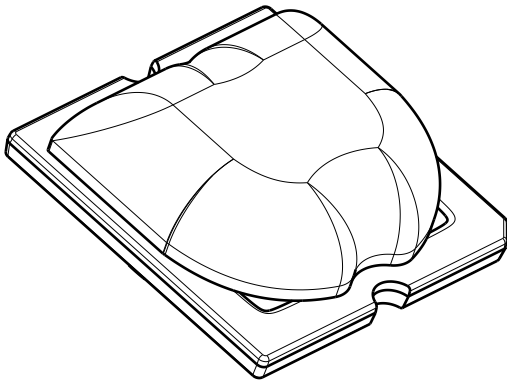

LED in center of the lens

21.5

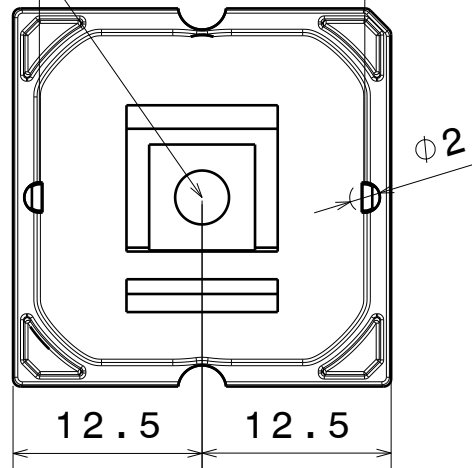

12.5

12.5

Ø 2

3

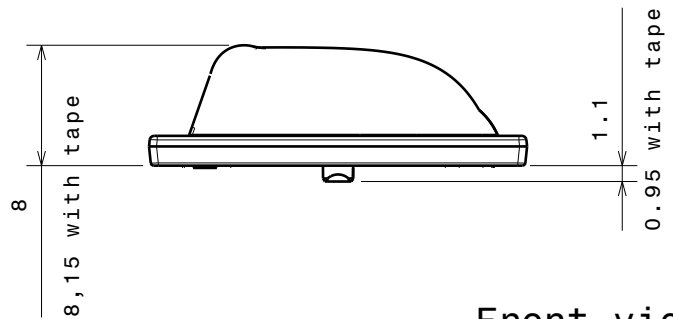

Front view

2

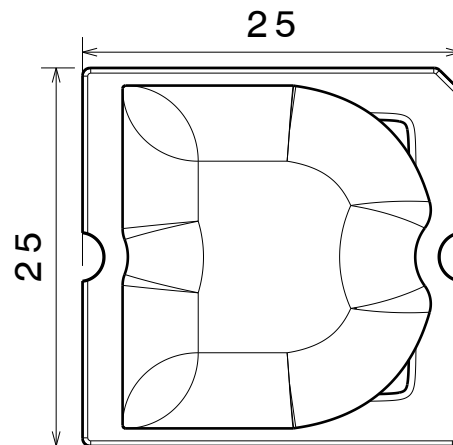

Top view

Materials:
Lens: PMMA

This drawing is our property.
It can't be reproduced
or communicated without
our written agreement.



Ledil Oy
Salorankatu 10
FIN 24240 SALO
Finland

DRAWING TITLE

Datasheet STRADA-SQ-DWC

DRAWN BY

ol

DATE

4.5.2012

CHECKED BY

PV

DATE

4.5.2012

DESIGNED BY

OL

DATE

24.4.2012

SIZE

A4

DRAWING NUMBER

C12726

REV

01

SCALE

2:1

WEIGHT (kg)

0,00

SHEET

1/1

D

A

1

1

Luminaire: Ledil Oy C12726_STRADA-SQ-T-DWC/CA12889_STRADA-SQ-T-DWC (Cree XM-L 90lm @ 250mA) Efficiency=94%
Lamps: 1 x Cree XM-L 90lm @ 250mA

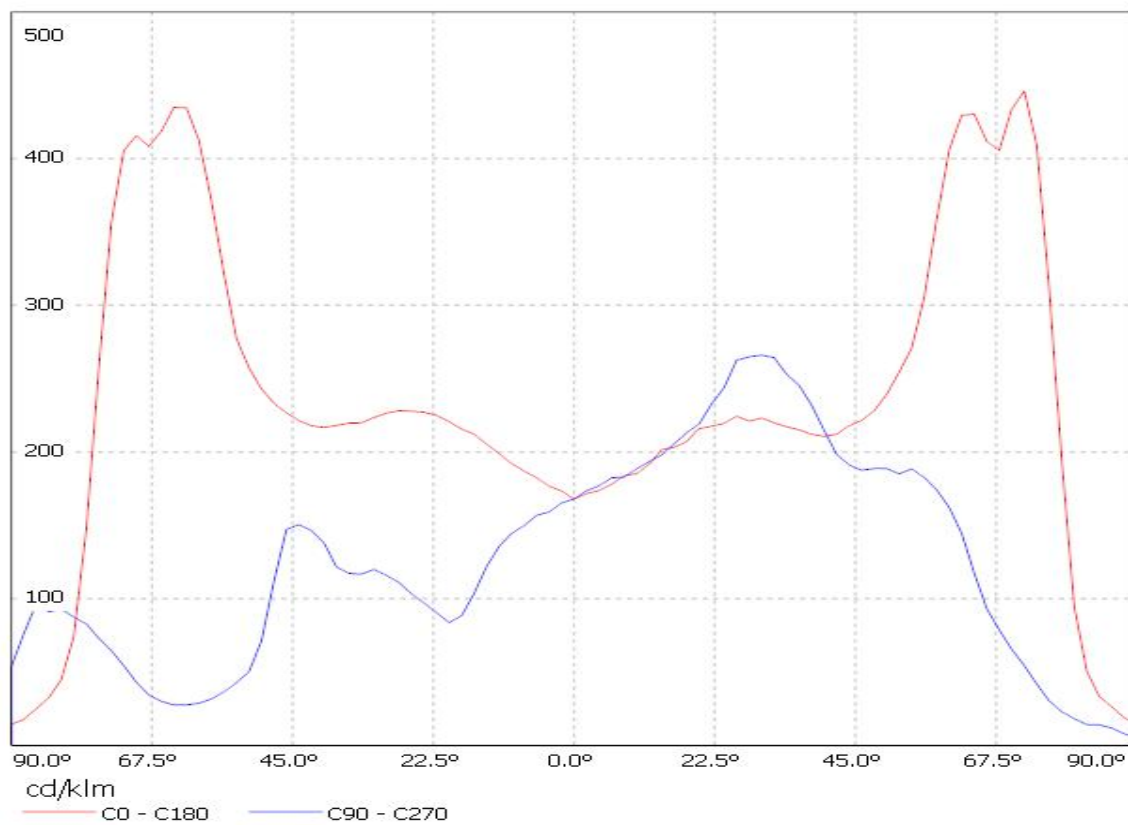

Luminaire: LEDil Oy CA12889_STRADA-SQ-T-DWC_(XM-L2) Efficiency=92%
Lamps: 1 x Cree XM-L2 (XMLBWT-0-7B4-T30-0L-0001) 91lm @ 250mA CCT=3220K P=0.7W I=250mA

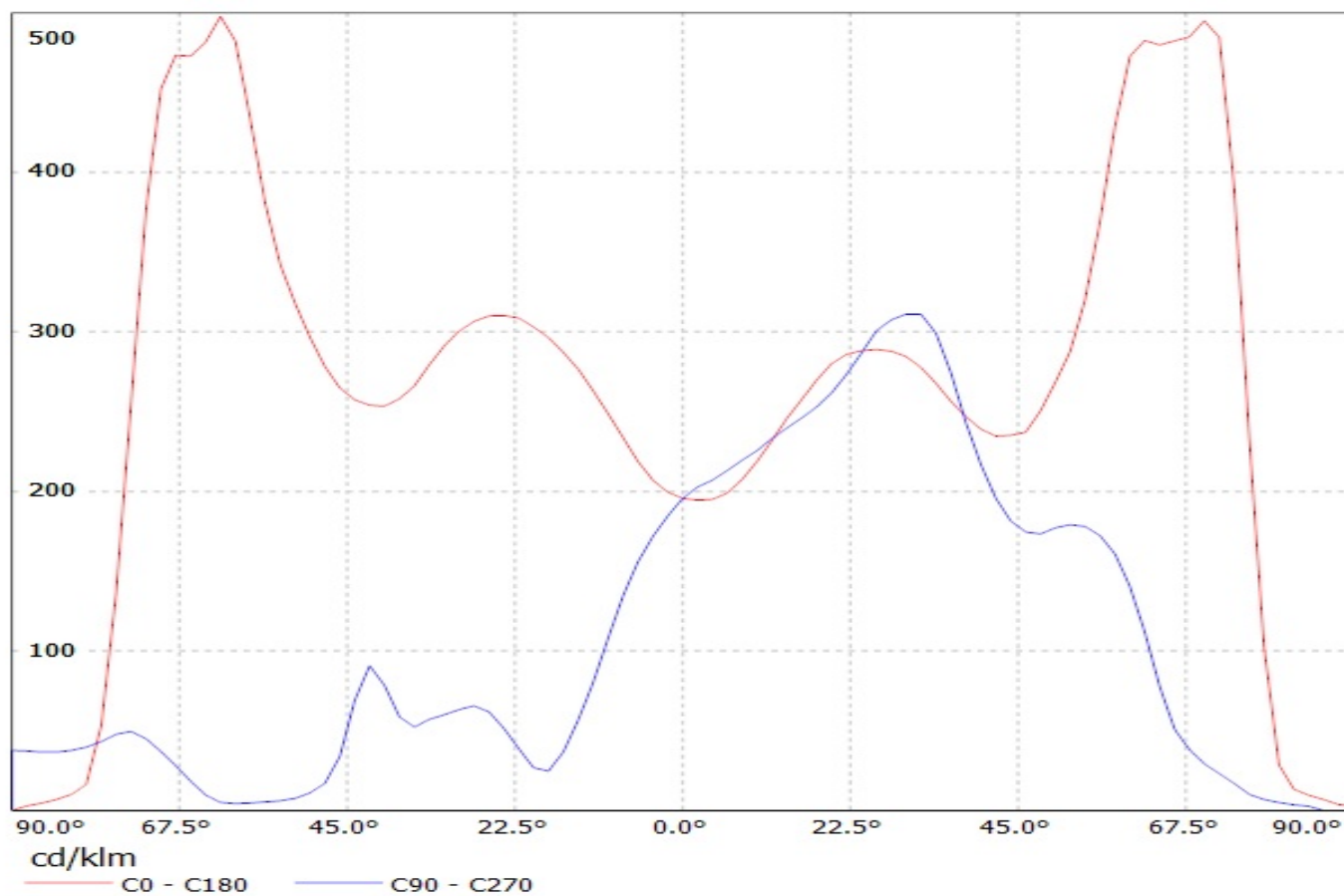

Luminaire: LEDiL Oy CA12889_STRADA-SQ-T-DWC_(MK-R) Eff.90.8%
Lamps: 1 x CREE MKR (362lm@250mA)

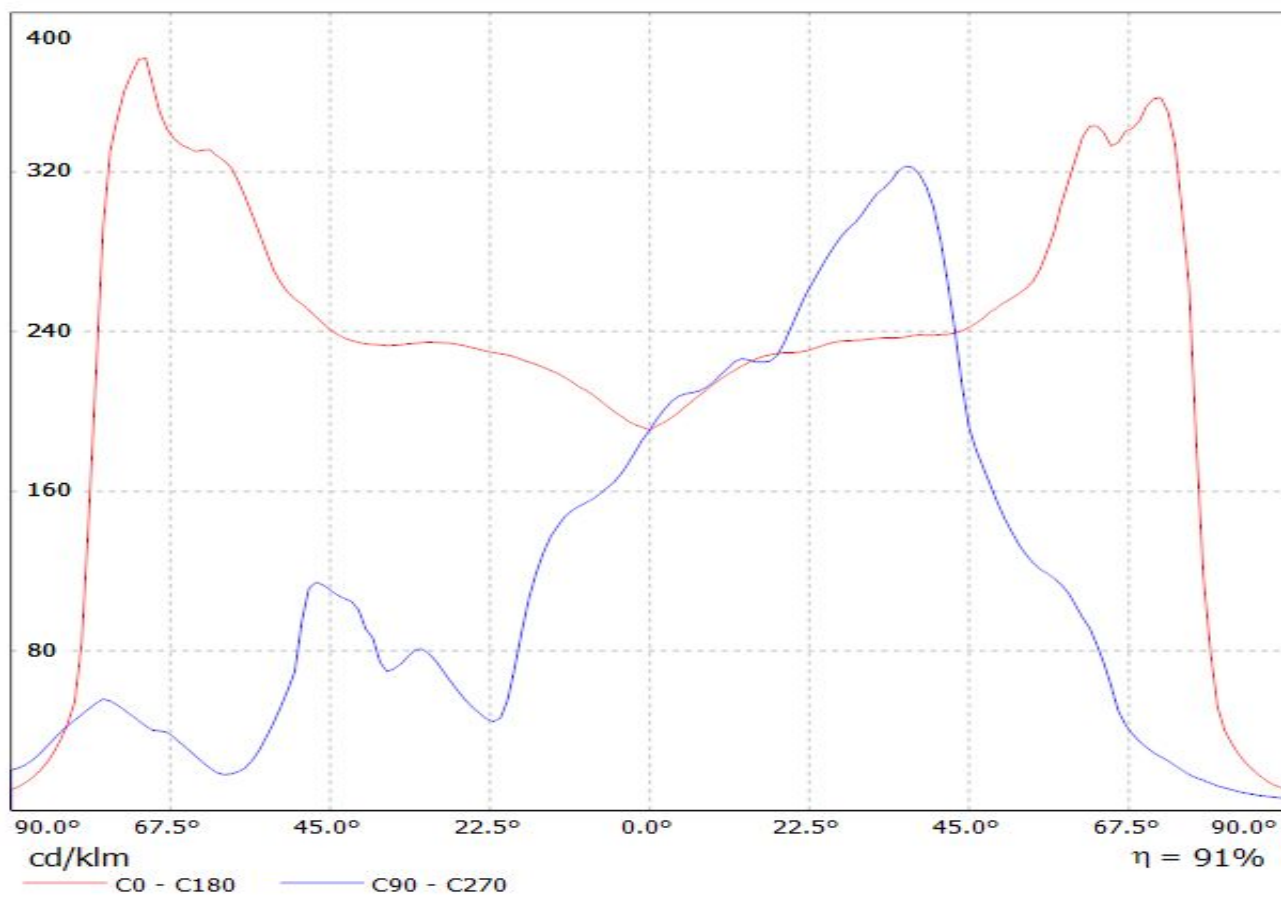

Luminaire: LEDiL Oy CA12889_STRADA-SQ-T-DWC_(CREE_XHP50_COOLWHITE)
Lamps: 1 x CREE_XHP50_COOLWHITE_242.798@0.250A_P=1.42658W_I=0.2499A

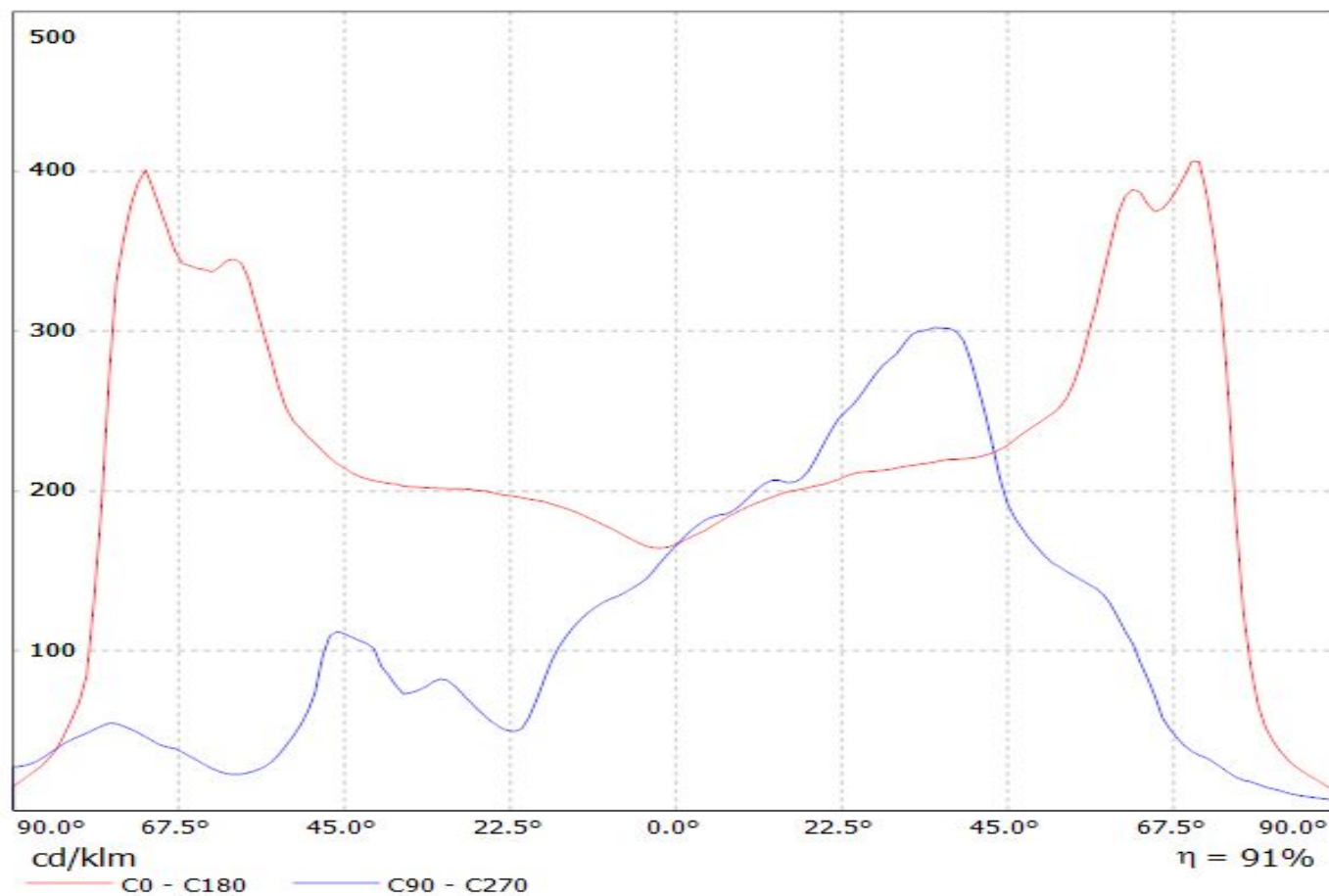

Luminaire: LEDiL C12726&CA12889_STRADA-SQ-T-DWC (Luxeon M) Efficiency=94%
Lamps: 1 x Luxeon M (360lm@250mA)

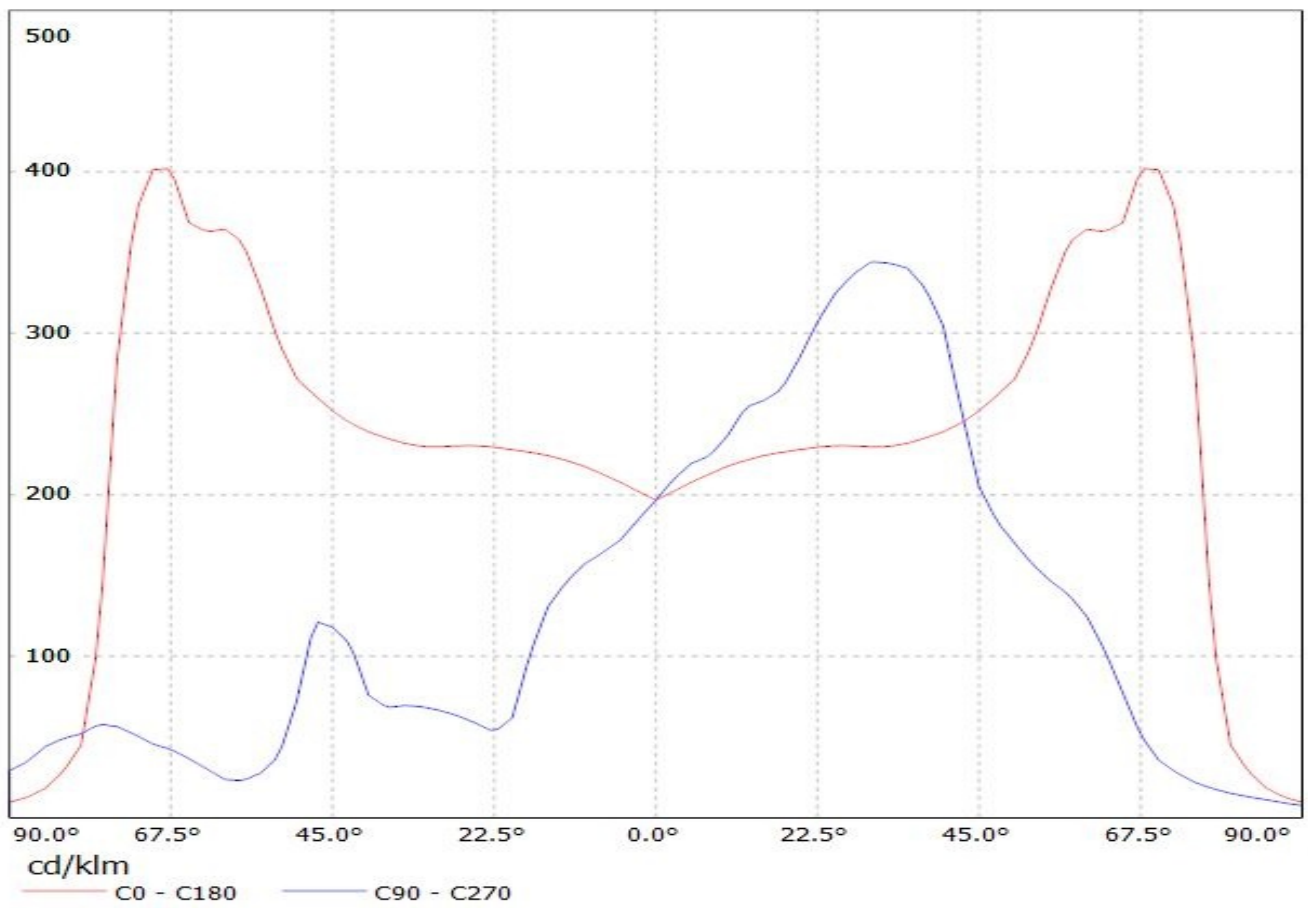

Luminaire: LEDiL Oy CA12889_STRADA-SQ-T-DWC_(LUXEON-MZ) Eff: 91%
Lamps: 1 x LUXEON-MZ_260.22lm@250mA_P=2.7399W_I=249.9mA

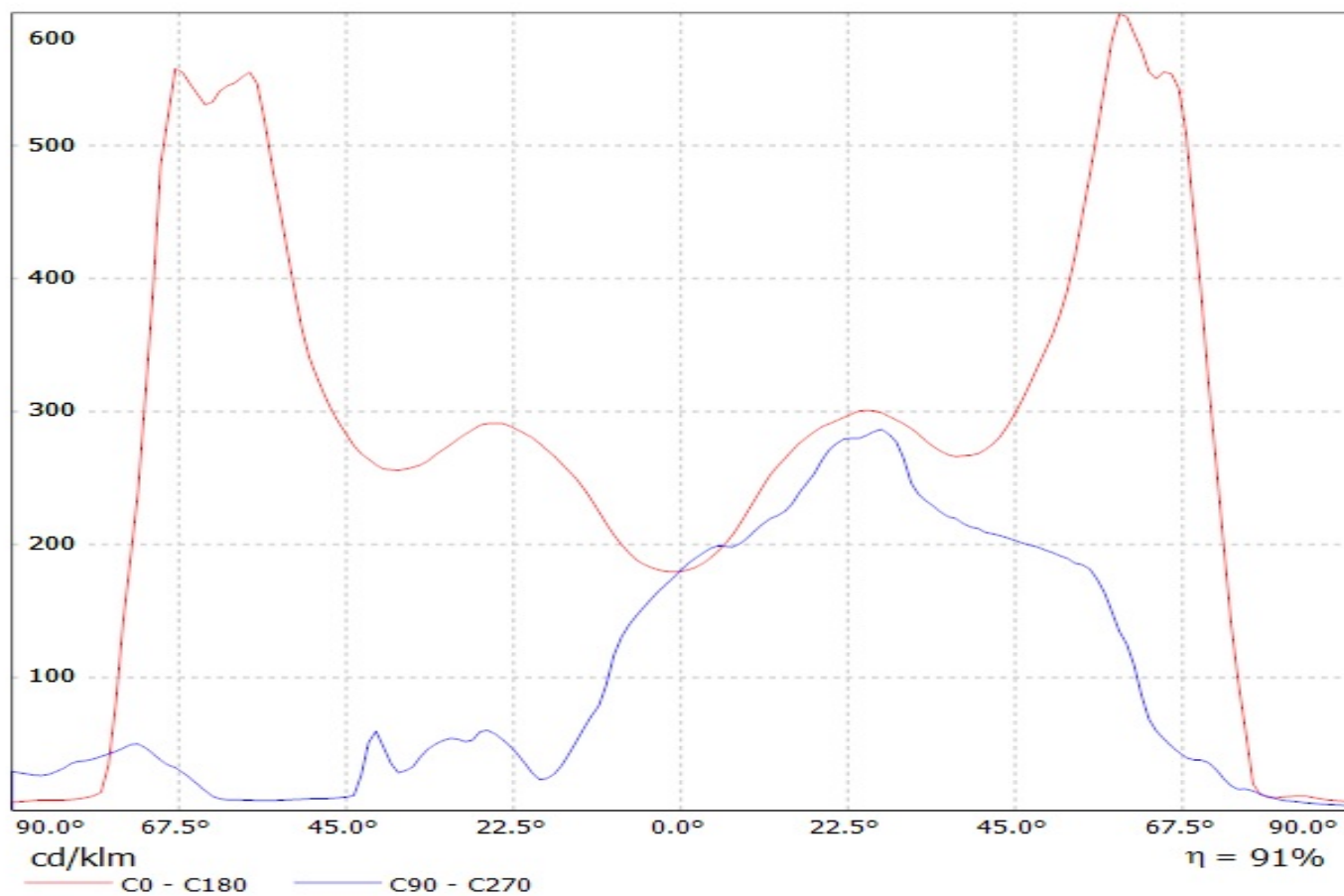

Luminaire: Ledil CA12889_STRADA-SQ-T-DWC_(LUXEON_XR-M_Linear_1x4)
Lamps: 1 x Lumiled_LUXEON_XR-M_Linear_1x4_1798.32lm@250mA_P=11.005W_I=0.25A

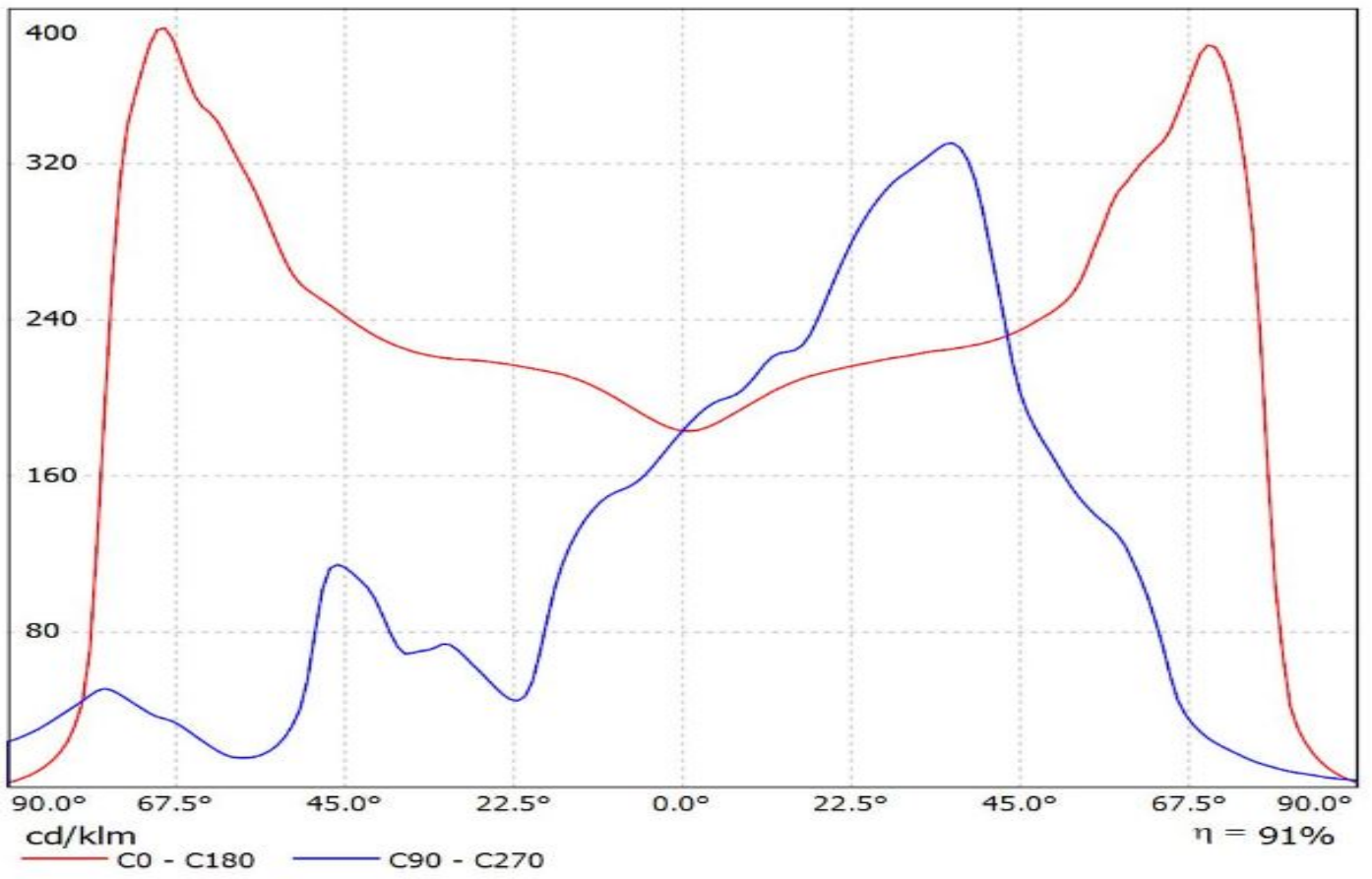

Luminaire: LEDiL Oy CA12889_STRADA-SQ-T-DWC_(NS9x383) Eff. 89,9%
Lamps: 1 x Nichia NS9x383 (105lm@250mA)

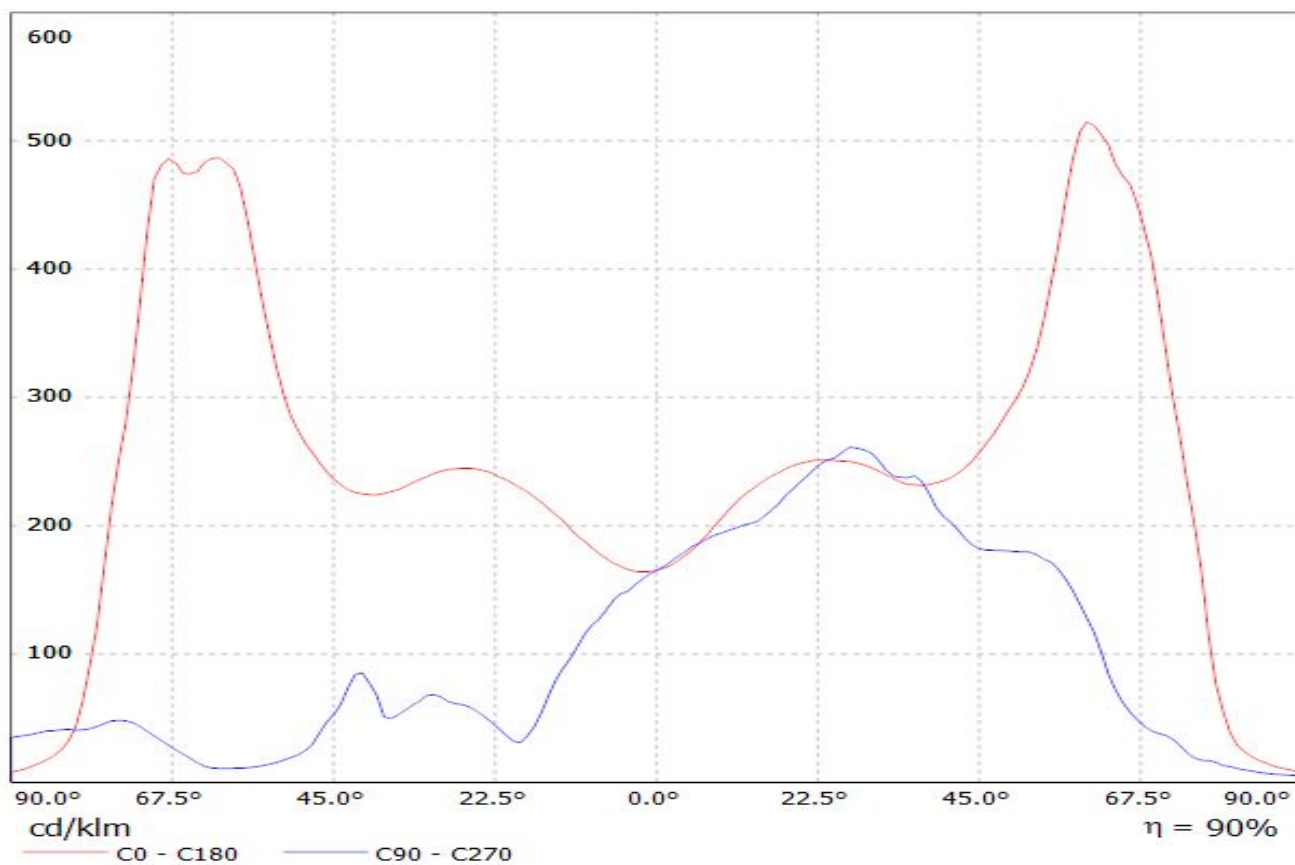

Luminaire: LEDiL Oy CA12889_STRADA-SQ-T-DWC_(NV4x144A)
Lamps: 1 x Nichia_NV4x144A_477.906lm@250mA_P=2.8045W_I=0.250A

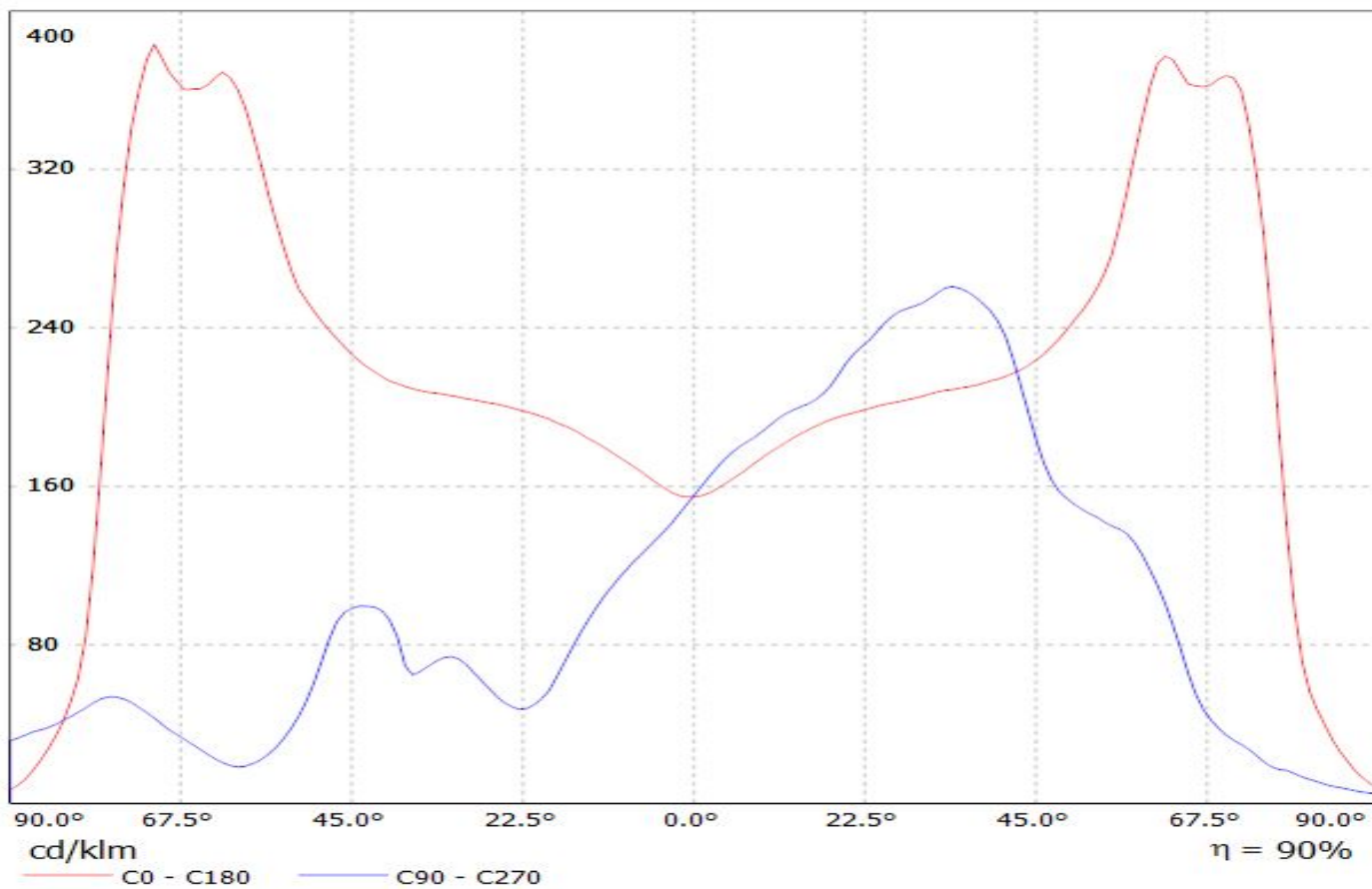

Luminaire: LEDiL Oy CA12889_STRADA-SQ-T-DWC_(OLP-5065F6L-06A) Eff.91.4%
Lamps: 1 x OPTOGAN_(OLP-5065F6L-06A-80-D05O0) 106.528lm@250mA CCT=5000K P=0.777664W I=249.9mA

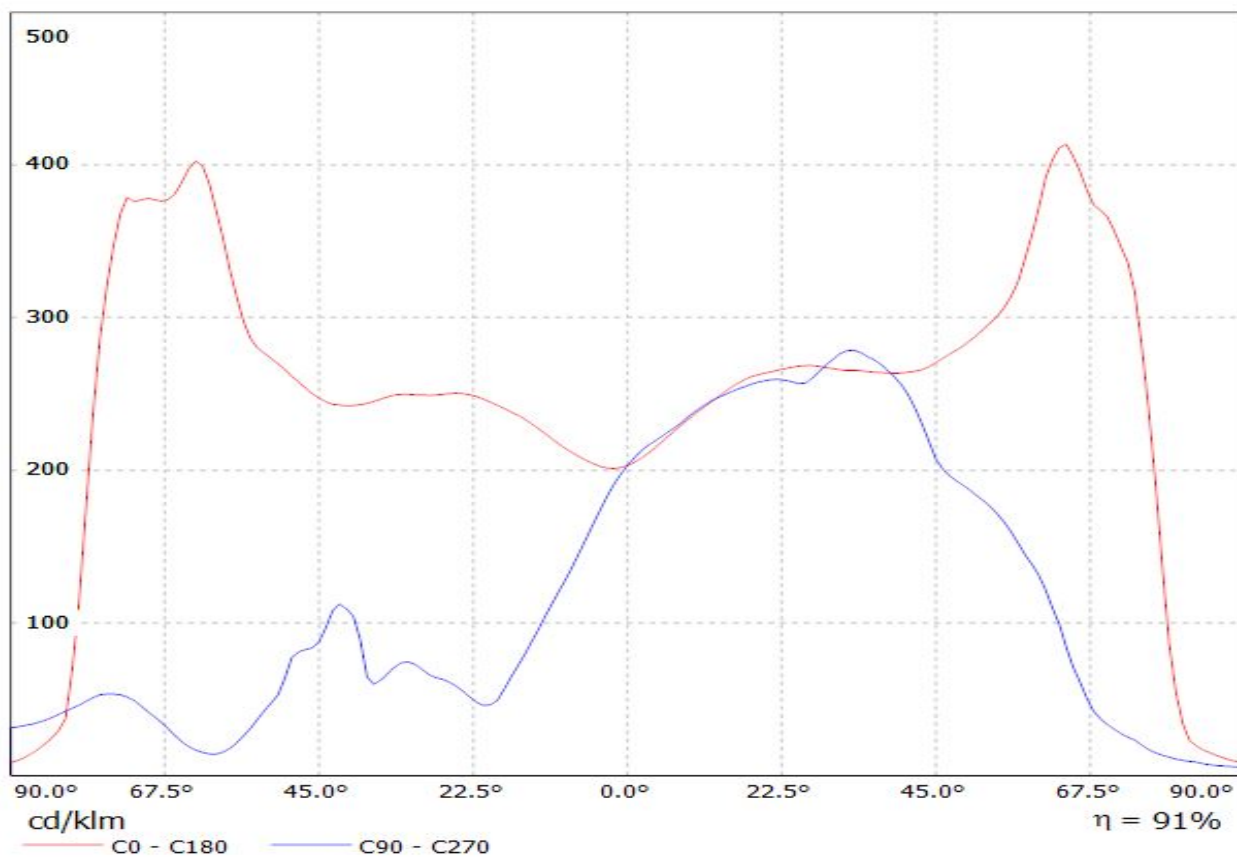

Luminaire: Ledil CA12889_STRADA-SQ-T-DWC_(Duris_S10)

Lamps: 1 x Osram_Duris_S10_(GW-P7LP32.EM)_992.375lm@250mA_P=9.2362W_I=0.25A

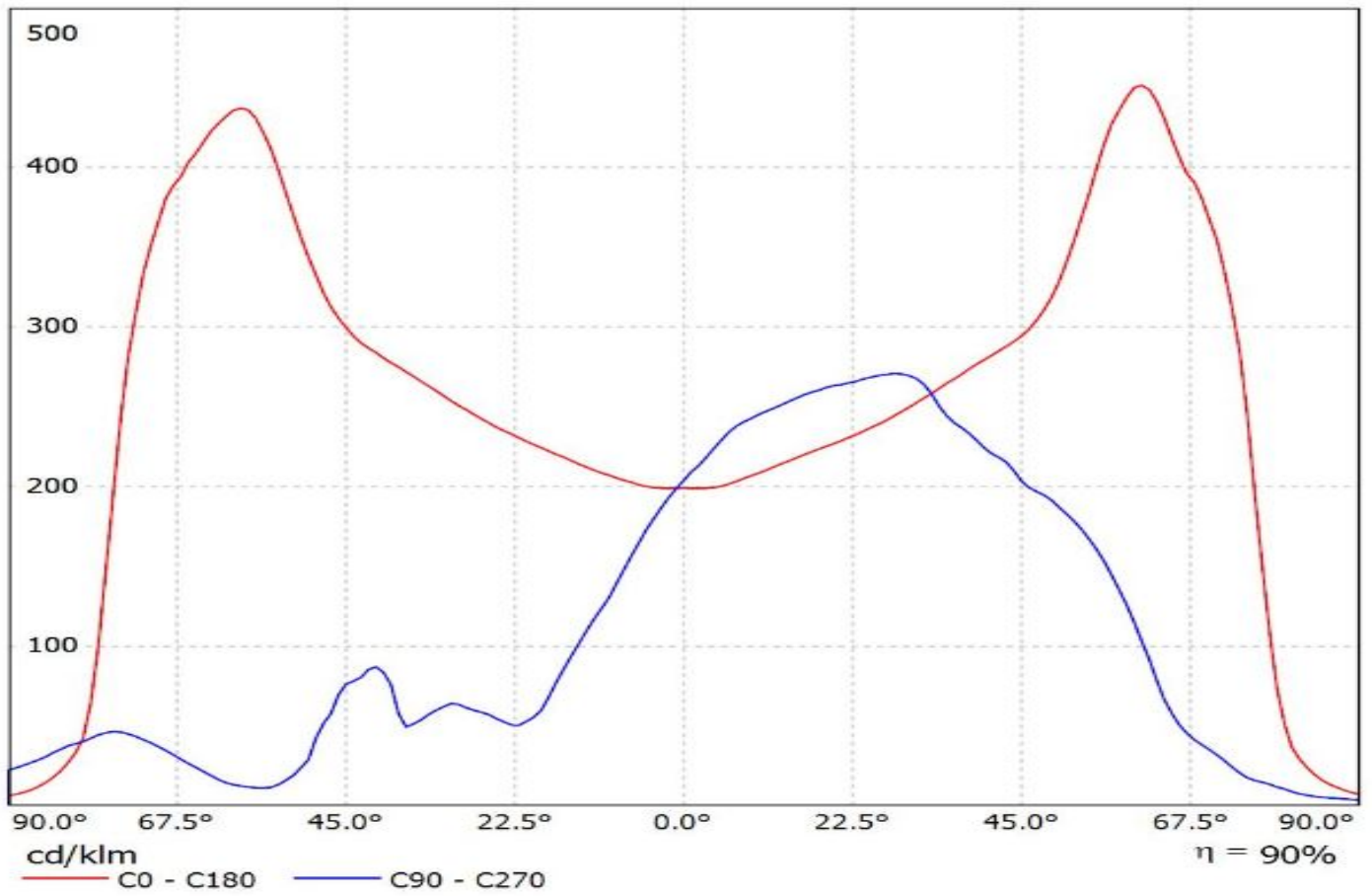

Luminaire: Ledil Oy C12726_STRADA-SQ-T-DWC/CA12889_STRADA-SQ-T-DWC (Cree XM-L 90lm @ 250mA) Efficiency=94%
Lamps: 1 x Cree XM-L 90lm @ 250mA

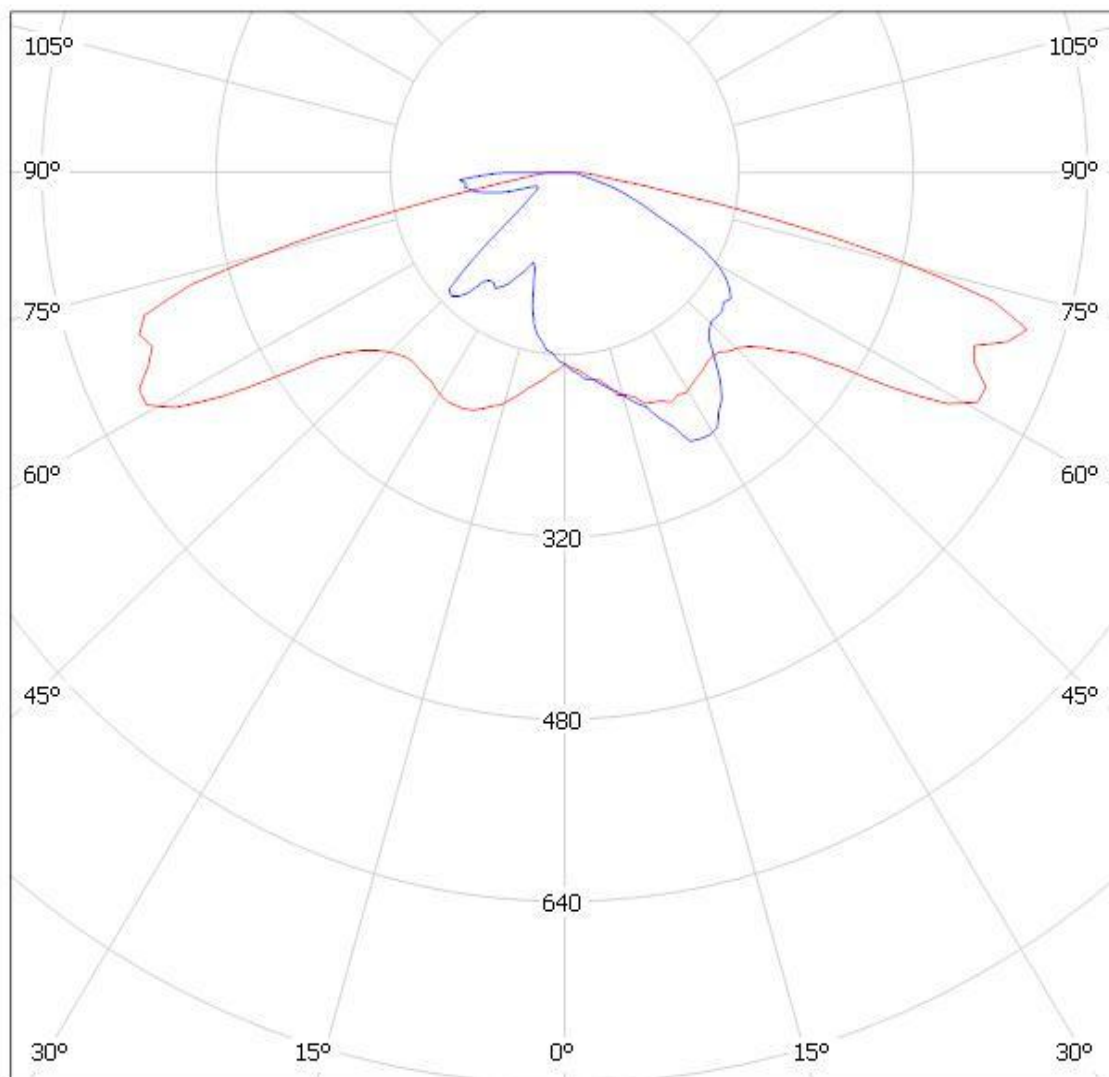

cd/klm

— C0 - C180

— C90 - C270

Luminaire: LEDil Oy CA12889_STRADA-SQ-T-DWC_(XM-L2) Efficiency=92%
Lamps: 1 x CRee XM-L2 (XMLBWT-0-7B4-T30-0L-0001) 91lm @ 250mA CCT=3220K P=0.7W I=250mA

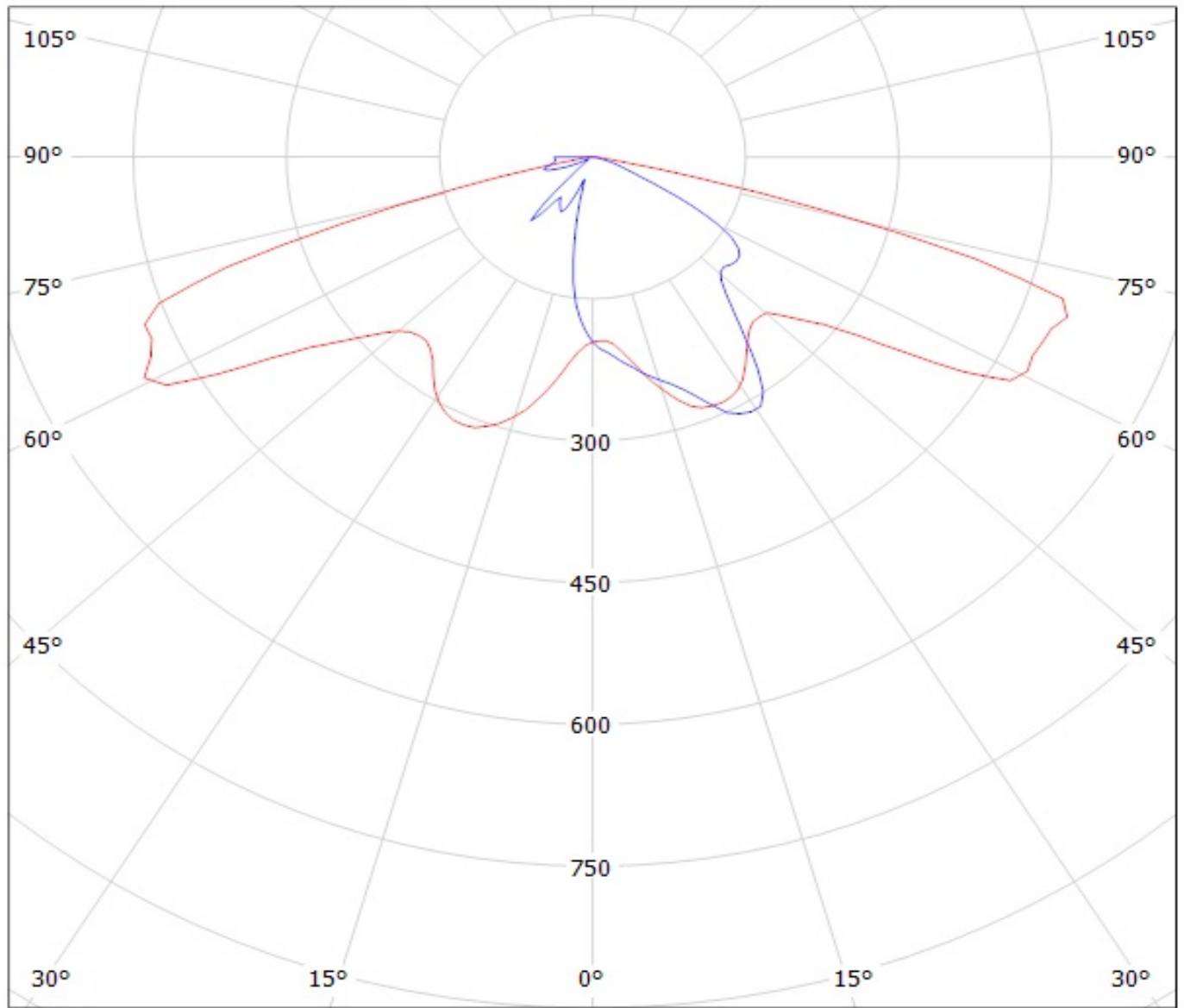

cd/klm

— C0 - C180

— C90 - C270

Luminaire: LEDiL Oy CA12889_STRADA-SQ-T-DWC_(MK-R) Eff.90.8%
Lamps: 1 x CREE MKR (362lm@250mA)

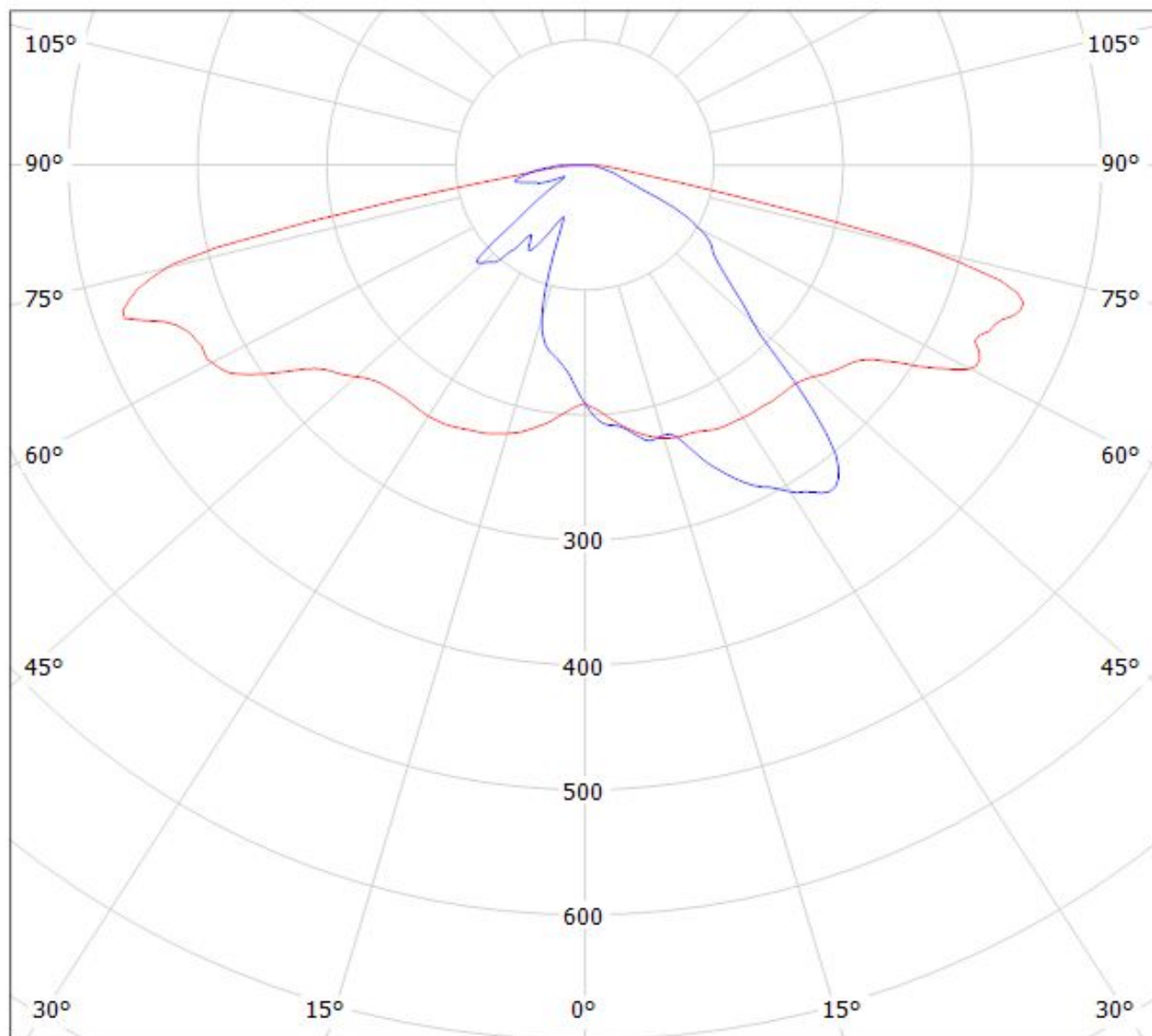

cd/klm

— C0 - C180 — C90 - C270

$\eta = 91\%$

Luminaire: LEDiL Oy CA12889_STRADA-SQ-T-DWC_(CREE_XHP50_COOLWHITE)
Lamps: 1 x CREE_XHP50_COOLWHITE_242.798@0.250A_P=1.42658W_I=0.2499A

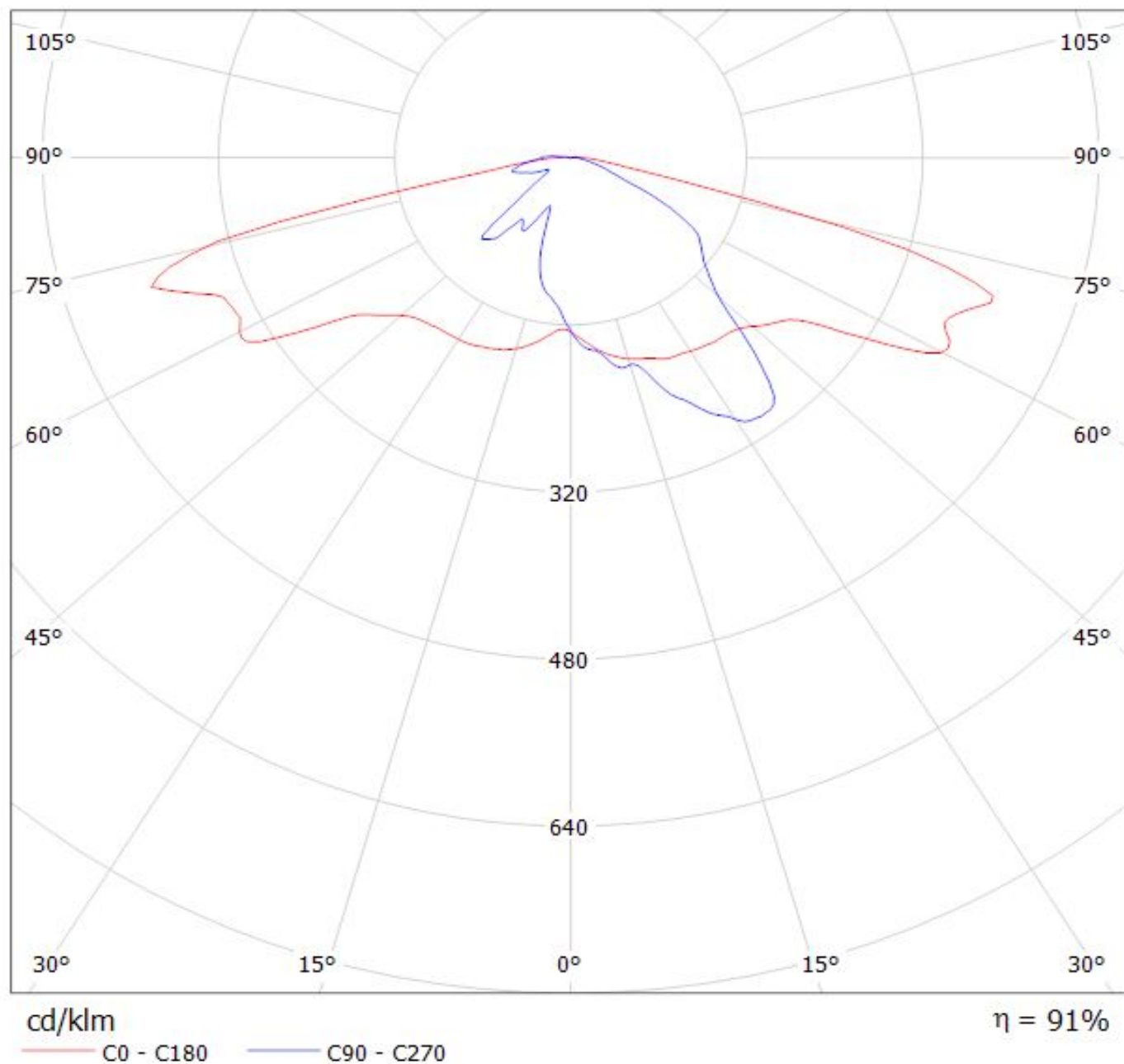

Luminaire: LEDiL C12726&CA12889_STRADA-SQ-T-DWC (Luxeon M) Efficiency=94%
Lamps: 1 x Luxeon M (360lm@250mA)

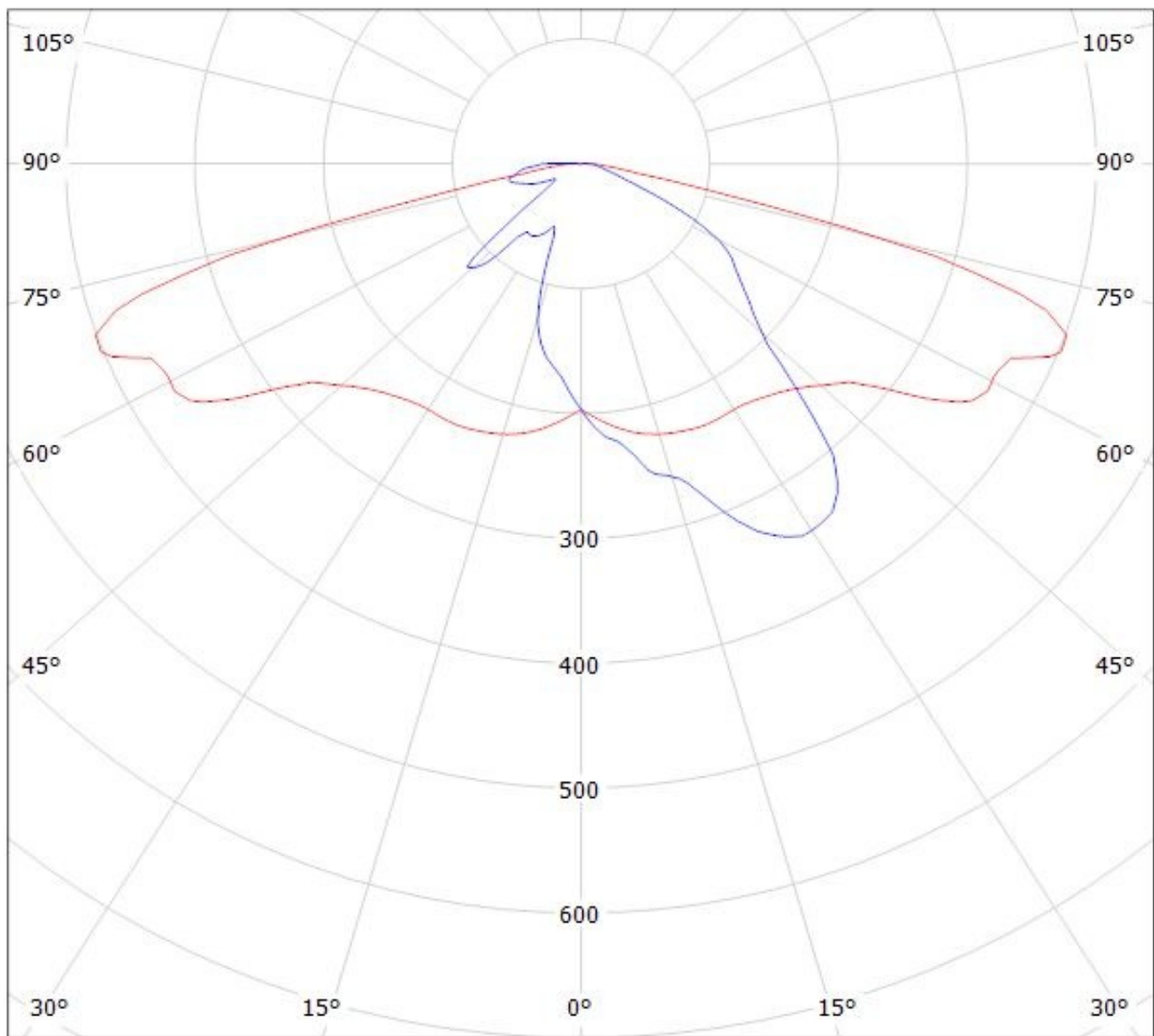

cd/klm

— C0 - C180

— C90 - C270

Luminaire: LEDiL Oy CA12889_STRADA-SQ-T-DWC_(LUXEON-MZ) Eff. 91%
Lamps: 1 x LUXEON-MZ_260.22lm@250mA_P=2.7399W_I=249.9mA

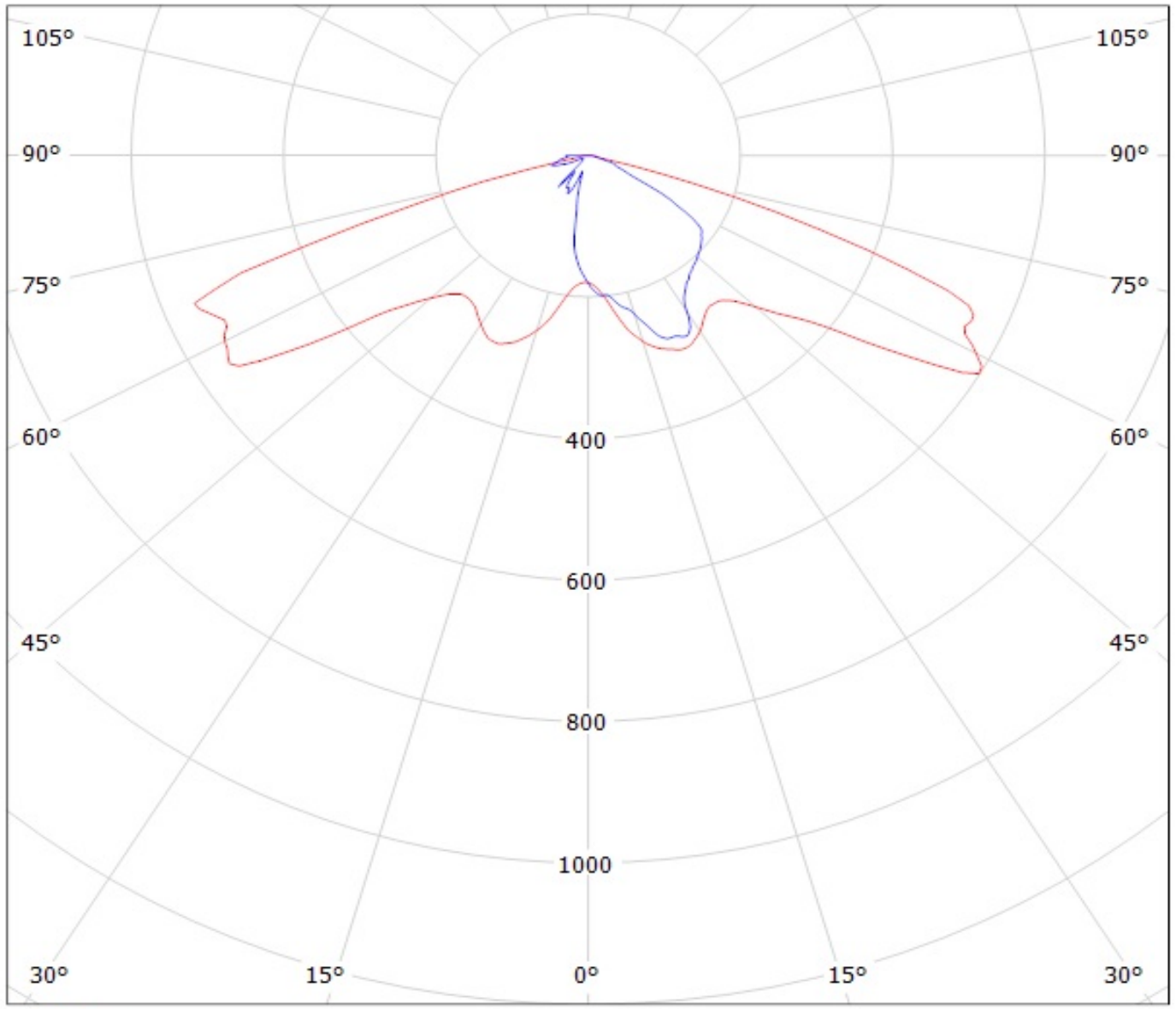

cd/klm
— C0 - C180 — C90 - C270

Luminaire: Ledil CA12889_STRADA-SQ-T-DWC_(LUXEON_XR-M_Linear_1x4)

Lamps: 1 x Lumiled_LUXEON_XR-M_Linear_1x4_1798.32lm@250mA_P=11.005W_I=0.25A

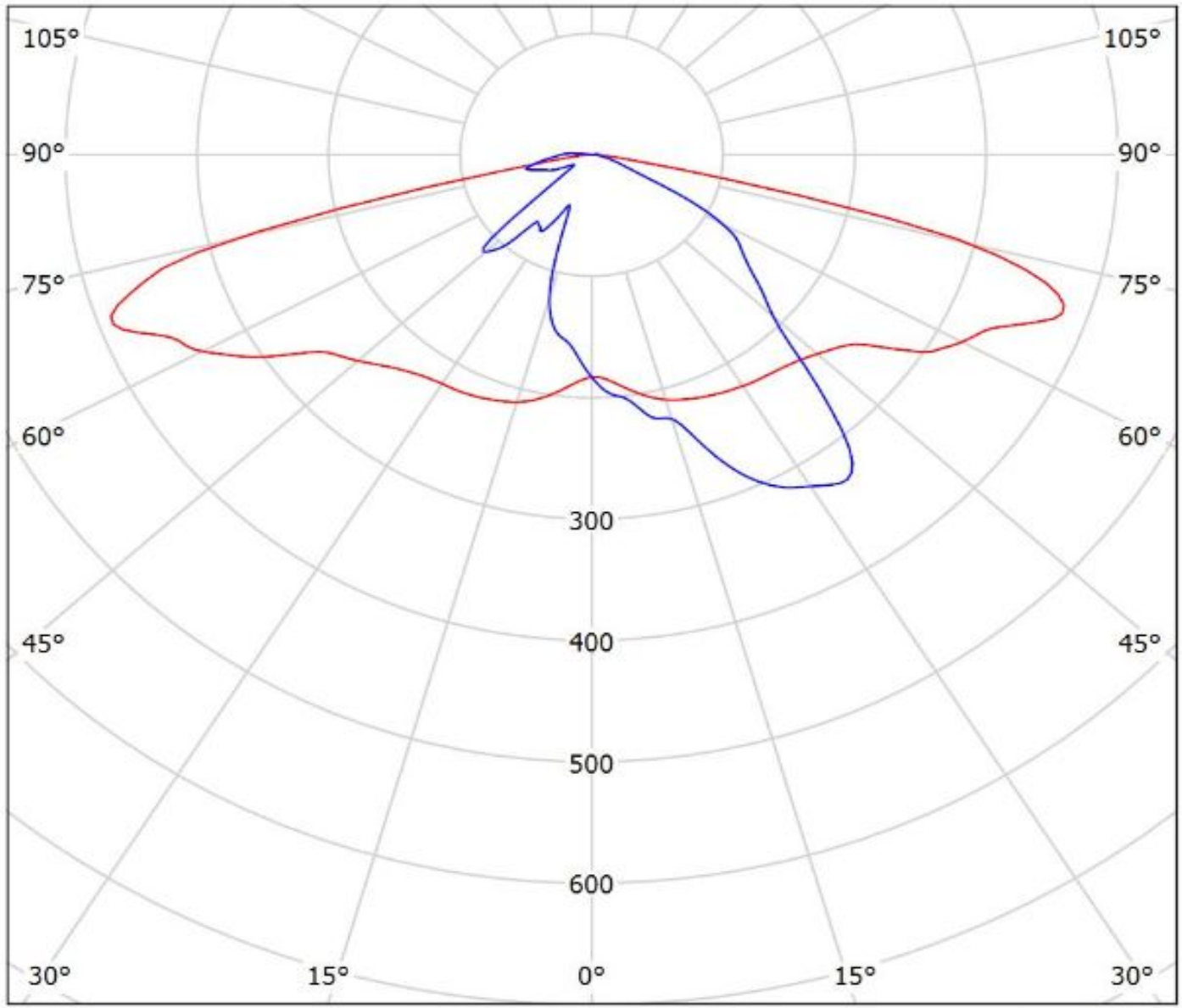

cd/klm

— C0 - C180 — C90 - C270

η = 91%

Luminaire: LEDiL Oy CA12889_STRADA-SQ-T-DWC_(NS9x383) Eff. 89,9%
Lamps: 1 x Nichia NS9x383 (105lm@250mA)

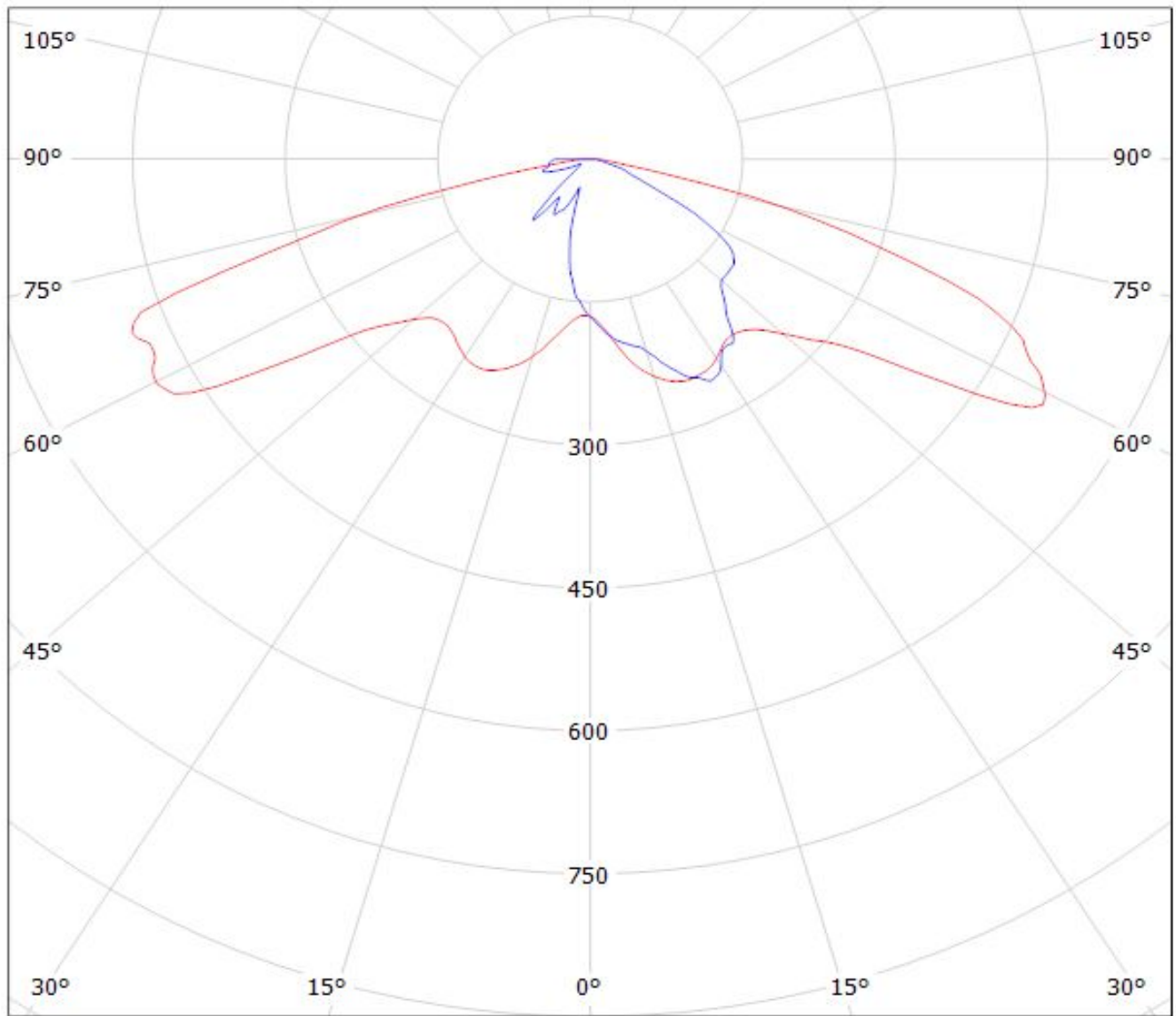

cd/klm

$\eta = 90\%$

— C0 - C180 — C90 - C270

Luminaire: LEDiL Oy CA12889_STRADA-SQ-T-DWC_(NV4x144A)
Lamps: 1 x Nichia_NV4x144A_477.906lm@250mA_P=2.8045W_I=0.250A

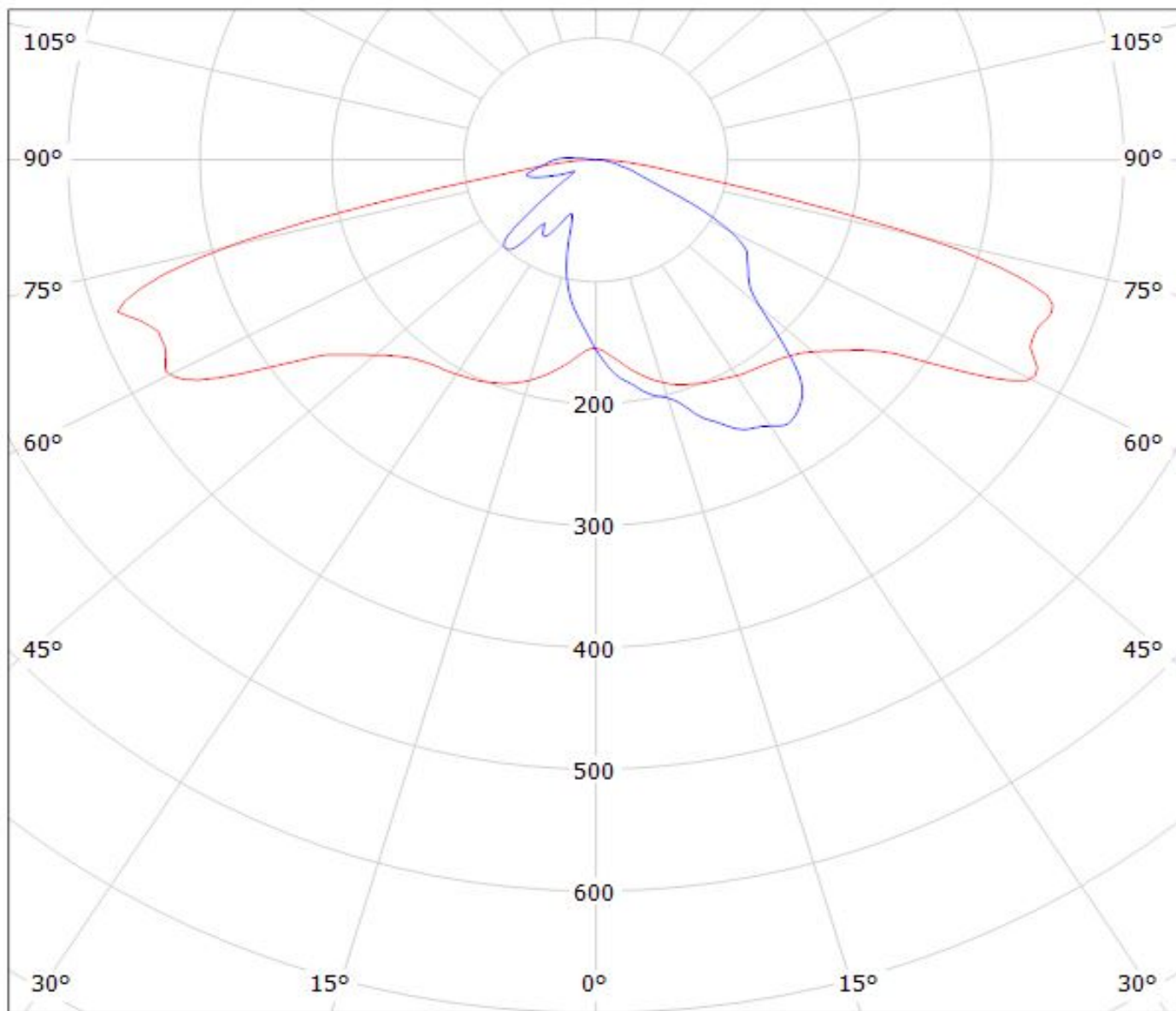

cd/klm

— C0 - C180 — C90 - C270

$\eta = 90\%$

Luminaire: LEDiL Oy CA12889_STRADA-SQ-T-DWC_(OLP-5065F6L-06A) Eff.91.4%
Lamps: 1 x OPTOGAN_(OLP-5065F6L-06A-80-D0500) 106.528lm@250mA CCT=5000K P=0.777664W I=249.9mA

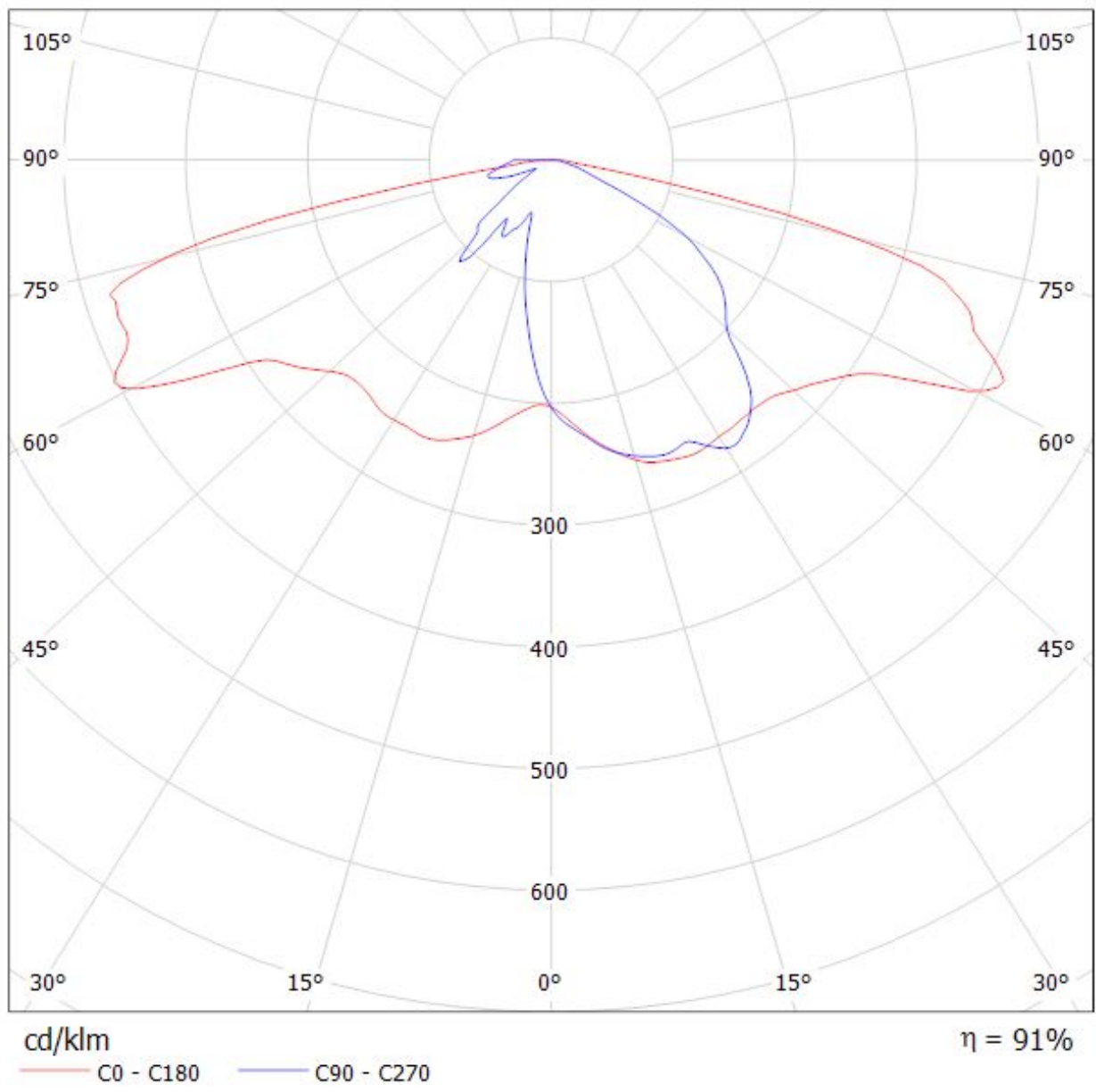

Luminaire: Ledil CA12889_STRADA-SQ-T-DWC_(Duris_S10)

Lamps: 1 x Osram_Duris_S10_(GW-P7LP32.EM)_992.375lm@250mA_P=9.2362W_I=0.25A

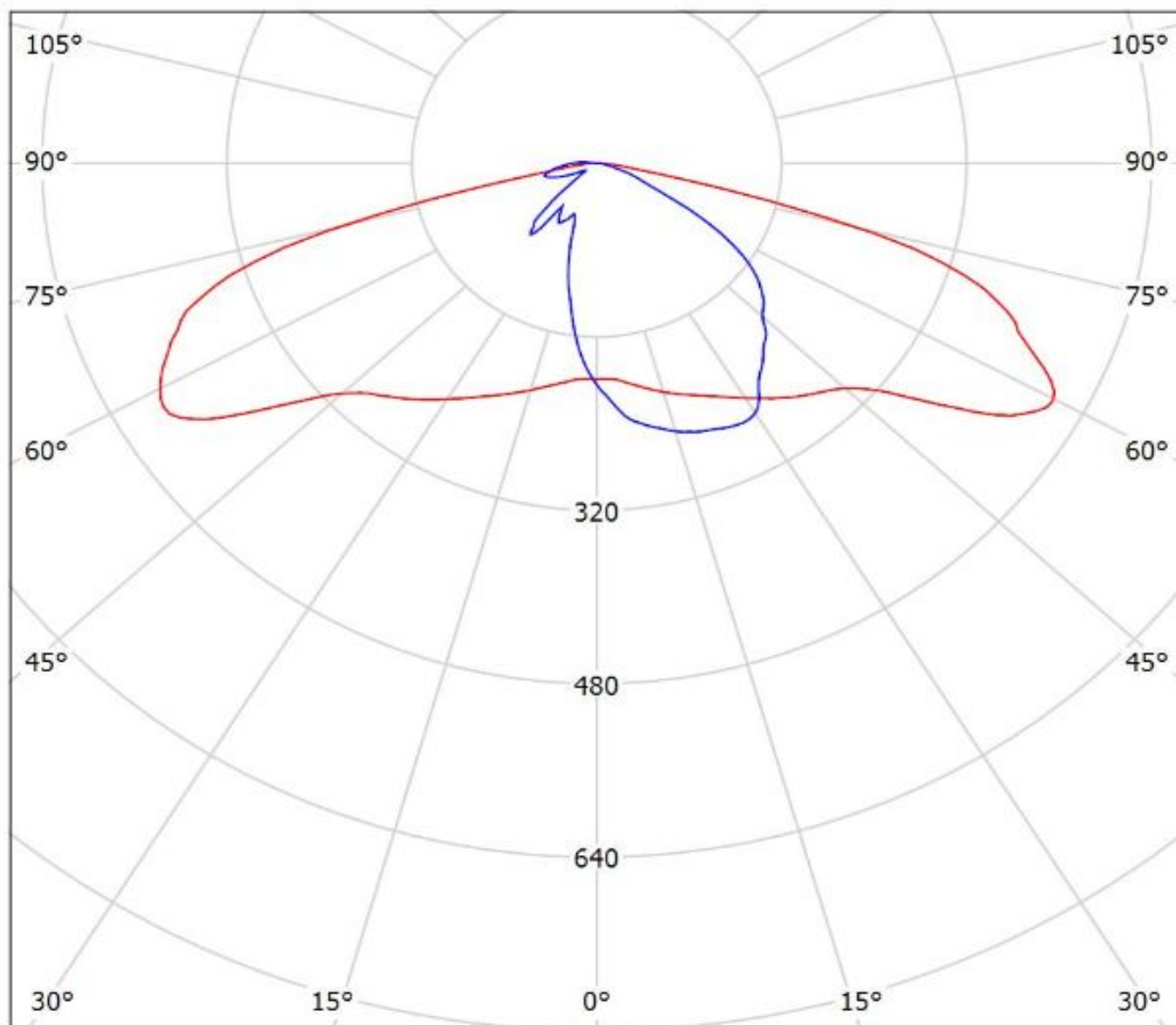

cd/klm

— C0 - C180 — C90 - C270

$\eta = 90\%$

NOTE: The typical divergence will be changed by different color, chip size and chip position tolerance. The typical total divergence is the full angle measured where the luminous intensity is half of the peak value.