

SOMDIMM-RX62N

Users Manual

For use with
Touch Screen LCD Kit

Copyright ©2011, Future Designs, Inc., All Rights Reserved

FDI ***Future Designs, Inc.***
Your Development Partner
2702 Triana Boulevard SW, Huntsville, AL 35805

Table of Contents

1. Introduction	4
2. RX62N SOMDIMM Block Diagram	4
3. Functional Description	5
4. ESD Warning	5
5. Requirements	5
6. SOMDIMM-RX62N Power Requirements	5
7. Setting up the Hardware	6
8. Demonstration Software Main Menu	7
9. PC to Demonstration Network Configuration	8
10. Setting up a Slideshow	10
11. Board Layout	11
12. DK-TS-KIT System Functional Block Diagram	12
13. I/O Connector Descriptions	13
JTAG Connector – CN1	13
MicroSD Connector – J1	14
14. On Board Functions	15
Ethernet PHY – U4	15
MicroSD – J1	15
Reset Generator – U7	15
15. 200-pin SOMDIMM Connector Details – J4	16
16. SOMDIMM Installation	19
17. SOMDIMM Socket Details	19
18. Mechanical Details	20
19. Software	21
20. Configuring Renesas HEW for J-Link Flashing	23
21. Functional Test Software	26
Configuring the Functional Test setup	26
Running Functional Test	26
22. Schematics	27
23. Table of Figures	27

Information in this document is provided solely to enable the use of Future Designs products. FDI assumes no liability whatsoever, including infringement of any patent or copyright. FDI reserves the right to make changes to these specifications at any time, without notice. No part of this document may be reproduced or transmitted in any form or by any means, electronic or mechanical, for any purpose, without the express written permission of Future Designs, Inc. 2702 Triana Blvd, Huntsville, AL 35805.

For more information on FDI or our products please visit www.teamfdi.com.

NOTE: The inclusion of vendor software products in this kit does not imply an endorsement of the product by Future Designs, Inc.

© 2011 Future Designs, Inc. All rights reserved.

uEZ® is a registered trademark of Future Designs, Inc.

Microsoft, MS-DOS, Windows, Windows XP, Microsoft Word are registered trademarks of Microsoft Corporation.

Other brand names are trademarks or registered trademarks of their respective owners.

FDI PN: MA00027

Revision: 1.0, 10/14/2011 3:04:00 PM

Printed in the United States of America

1. Introduction

The SOMDIMM-RX62N provides a quick and easy solution for implementing Renesas RX62N based design by providing the basic functions necessary for a product on an easy to use SOMDIMM. The SOMDIMM uses an industry standard 200 pin SO-DIMM interface. These sockets are utilized by virtually every laptop on the market.

This SOMDIMM is compatible with FDI’s Family of Touch Screen LCD Kits but can also be used for custom platform development or customer applications.

2. RX62N SOMDIMM Block Diagram

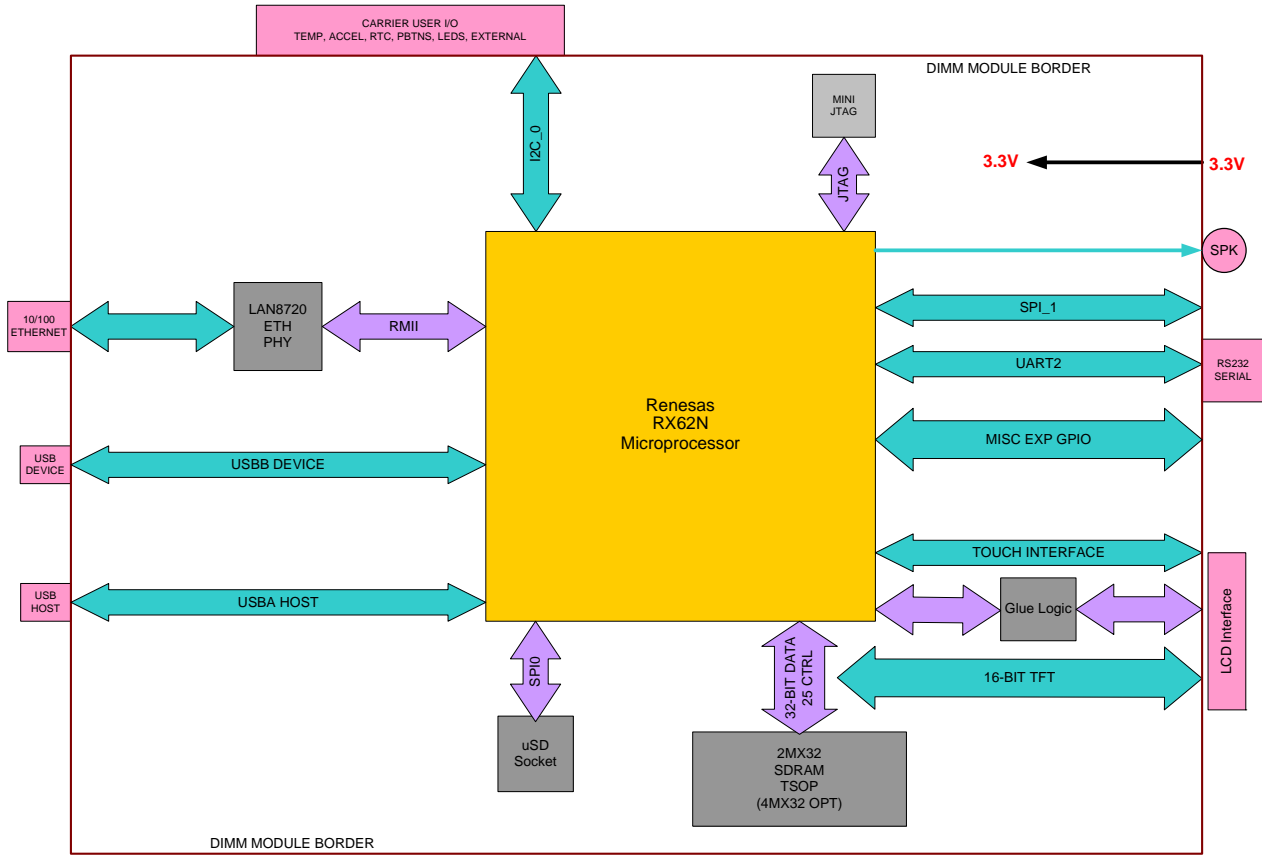

Figure 1 – RX62N SOMDIMM Block Diagram

3. Functional Description

SOMDIMM-RX62N

- Renesas RX62N based Microprocessor
- 2Mx32 SDRAM (8Mega-bytes)
- 10/100 Ethernet PHY
- Micro SD Card Socket for up to 2Giga-bytes storage (SDHC is not supported)
- Mini JTAG
- Power-on Reset Generator

4. ESD Warning

The DK-TS-KIT shipped in a protective anti-static package. The kit must not be subjected to high electrostatic potentials. Damage may occur to the boards that will not be covered under warranty. General practice for working with static sensitive devices should be followed when working with the DK-TS-KIT.

5. Requirements

The SOMDIMM-RX62N requires a carrier board with a 200-pin SO-DIMM socket. The socket should have the key at the 1.8V location (the SOMDIMM-RX62N doesn't require 1.8V). The CARRIER Board from Future Designs provides this socket and should be utilized to develop your application for initial verification.

Example SO-DIMM Socket Manufacturer and Part Number: TYCO 1473005-4

Please refer to section 10 for the pin out details of the SOMDIMM Edge Finger.

6. SOMDIMM-RX62N Power Requirements

The following power requirements were measured at room temperature at 96MHz operating clock rate:

Voltage	Booted at the uEZ Demo Screen	Observed Max
3.36V	126mA	128mA

7. Setting up the Hardware

The following are step by step instructions for setting up the hardware.

- 1) Make sure you have a SOMDIMM-RX62N board plugged into the CARRIER board at J1.
- 2) Verify the LCD Interface ribbon cable connects the CARRIER board to the LCD CARRIER (J7) board.
- 3) With the power off, plug the 5V center-positive Power Supply into 5V (P5) of the CARRIER board.
- 4) Connect an RJ-45 Ethernet cable to the ETHERNET (J5) interface of the CARRIER board.
- 5) Plug in a female-to-female DB9 serial cable (not included in the DK-TS-KIT) between PC and RS232 (P4)
- 6) Insert the microSD card with the demonstration files (included) into microSD connector on the SOMDIMM.
- 7) Turn on the power. The title screen should appear and a short tune is played. The main menu will appear.
- 8) After connecting all of the above, your configuration should look similar to the following:



8. Demonstration Software Main Menu

The Demonstration Software has the following options:

- **Slideshow**
Loads up to nine slides from the flash drive and allows the user to scroll up and down through the material. Slide back to the load screen to return to the main menu. See **Setting up a Slideshow** for details on how to customize.
- **Draw**
A very simple art program is provided. Use the touch screen to draw lines in the box to the right. Click on **Color** to rotate through a list of color choices. **Save** stores the graphic image as the file IMAGE.RAW on the microSD card. **Load** recalls the saved graphic image from the microSD card.
- **Console**
Presents an output screen showing what a remote user sees when Telnetting into the console. On a Windows PC, configure the PC as explained in **PC to Demonstration Network Configuration**, then open a CMD window and type “telnet 192.168.10.20” to connect to the DK-TS-KIT. Type “quit” to disconnect.
- **Time & Temperature**
Displays the current time and date from the external Real Time Clock (RTC) and the temperature from the LM75 temperature sensor on the CARRIER board.
- **Accelerometer**
Demonstrates the accelerometer by moving a simulated ball across the screen as the CARRIER board is tilted along the X and Y axis.
- **Settings**
Displays the submenu screen.
- **Calibrate**
Calibrates the Touch Screen and stores the new calibration information in the NV Storage on the SOMDIMM.
- **Functional Test**
Provides a step by step test of all basic features of the DK-TS-KIT. Requires additional hardware to test all features. See **Functional Test Software** section for more details.
- **FCT Loopback**
Puts the unit into a mode that will communicate with another DK-TS-KIT running the **Functional Test**. See **Functional Test Software** section for more details.

9. PC to Demonstration Network Configuration

In order to communicate via Ethernet to the DK-TS-KIT, the PC's network configuration will need to be changed. The simplest method is to give the PC another IP number and add the PC to another subnet. If using Windows XP, follow these instructions. Other operating systems should have similar operations.

Start by going to the **Control Panel** and select **Network Connections**. Then double click the **Local Area Connection** (or similarly named) and click **Properties**. The following dialog should appear. Scroll down to "Internet Protocol (TCP/IP)", select, and then click **Properties**.

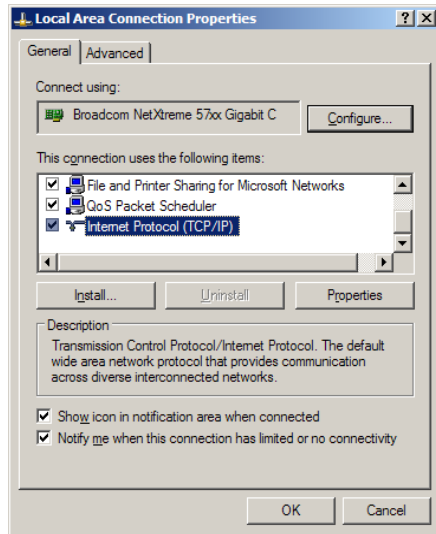

On the next screen, the computer needs to be set to a static IP number. Enter the current IP address, subnet mask, default gateway, and DNS servers (enter the command "ipconfig /all" at a CMD window to get this information). Then click **Advanced** and then click **Add...** and enter the following information and then click **Add**. Click **OK**. Click **OK**.

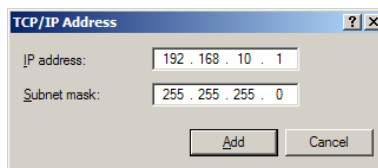

Open another CMD window and type the command “ping 192.168.10.20” and should output the following:

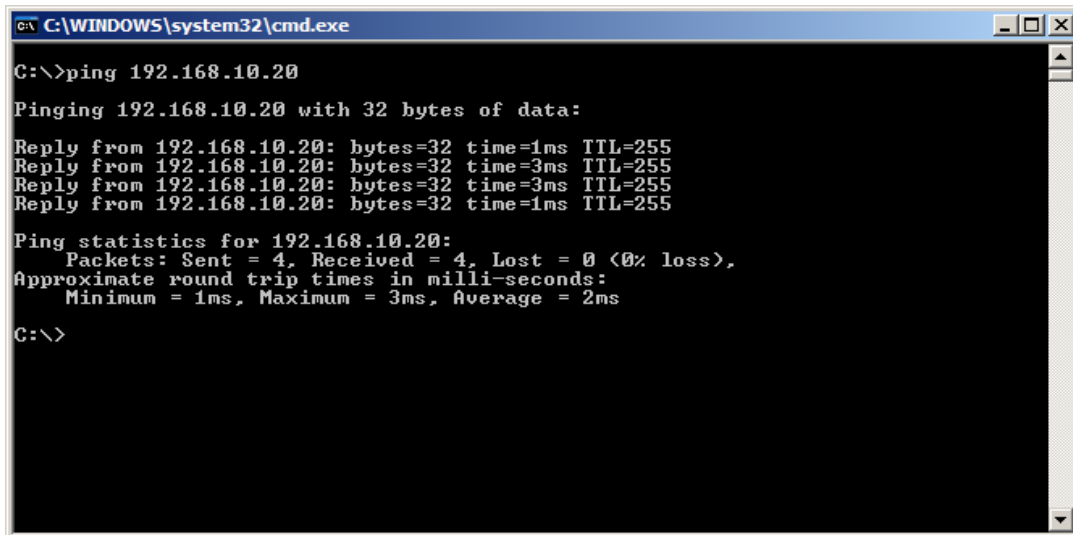

```
C:\WINDOWS\system32\cmd.exe
C:\>ping 192.168.10.20
Pinging 192.168.10.20 with 32 bytes of data:
Reply from 192.168.10.20: bytes=32 time=1ms TTL=255
Reply from 192.168.10.20: bytes=32 time=3ms TTL=255
Reply from 192.168.10.20: bytes=32 time=3ms TTL=255
Reply from 192.168.10.20: bytes=32 time=1ms TTL=255
Ping statistics for 192.168.10.20:
    Packets: Sent = 4, Received = 4, Lost = 0 (0% loss),
    Approximate round trip times in milli-seconds:
        Minimum = 1ms, Maximum = 3ms, Average = 2ms
C:\>
```

Open a browser and go to <http://192.168.10.20> and watch the output. It should appear as follows:

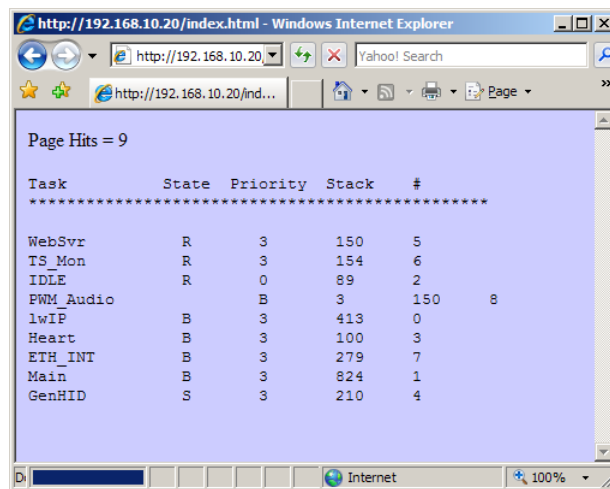

States are: R = Running, B = Blocked, S = Suspended, D = Deleted

NOTE: Blocked means the task is waiting for an event and has a timeout specified, Suspended means it also waiting but has no timeout.

The Stack value is the stack watermark representing the lowest amount of stack left in 32-bit words. For example, in your screenshot, the WebSvr task has always had $150 * 4 = 600$ bytes (or more) available in its stack.

is the task control block number in FreeRTOS. In short, it is the unique number for an active task.

10. Setting up a Slideshow

The Slideshow demonstration loads and scrolls between images provided on a microSD Card. Images must be in 24 bit uncompressed Targa (.TGA) format. Adobe Photoshop and many other graphics programs can save images in this format.

When using DK-TS-KIT's with a WQVGA LCD (e.g. DK-43WQT-RX62N), the images must be 480x272 in size and use the file names WQSLID01.TGA, WQSLID02.TGA, WQSLID03.TGA, etc.

11. Board Layout

The following figures illustrate the layout of the various components of the DK-TS-KIT. They are for reference only and are subject to change.

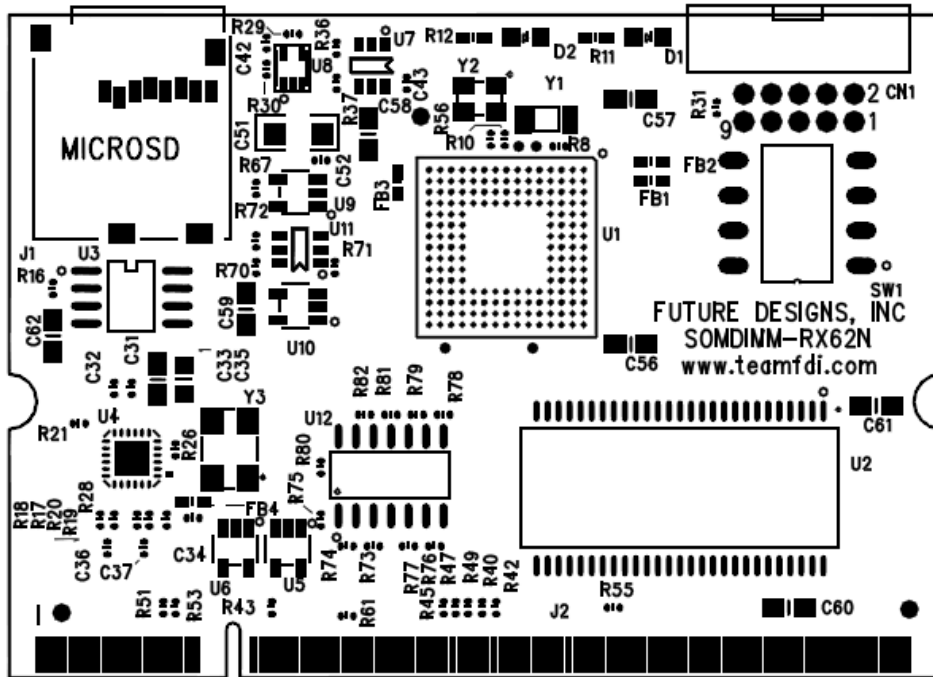

Figure 2 – SOMDIMM-RX62N Side

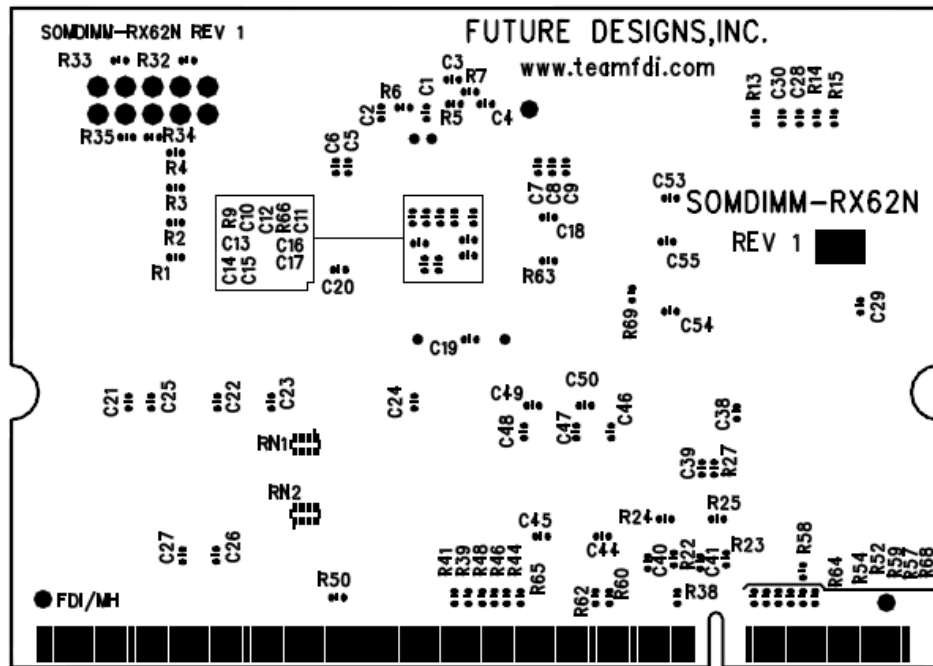

Figure 3 – SOMDIMM-RX62N Bottom Side

12. DK-TS-KIT System Functional Block Diagram

The DK-TS-KIT Block Diagram is illustrated below. (5.7" QVGA shown)

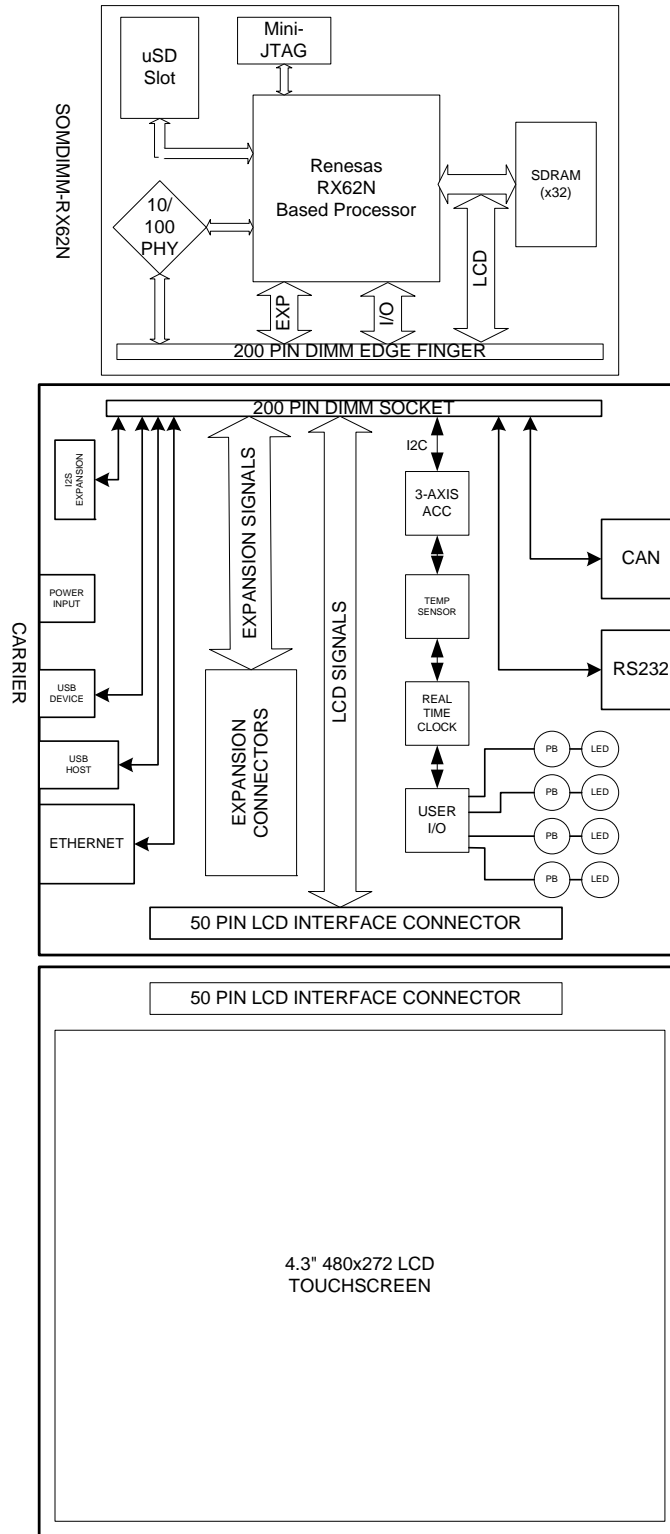

Figure 4 – DK-TS-KIT System Block Diagram

13. I/O Connector Descriptions

JTAG Connector – CN1

The SOMDIMM-RX62N uses a new, reduced size JTAG connector based on a 2mm Header. This smaller connector provides 100% of the functionality of the standard 20-pin JTAG connector, but utilizes 70% less board space. The connector is a standard part available from most major vendors.

Pin Number	Description
1	GND
2	NC
3	TDO
4	Reset
5	TCK
6	NC
7	TDI
8	TMS
9	VCC
10	TRSTn

For users that may have existing JTAG debuggers, an adapter may be fabricated using the following wiring diagram: (part numbers for the connectors are included from both the manufacturer and Digi-key)

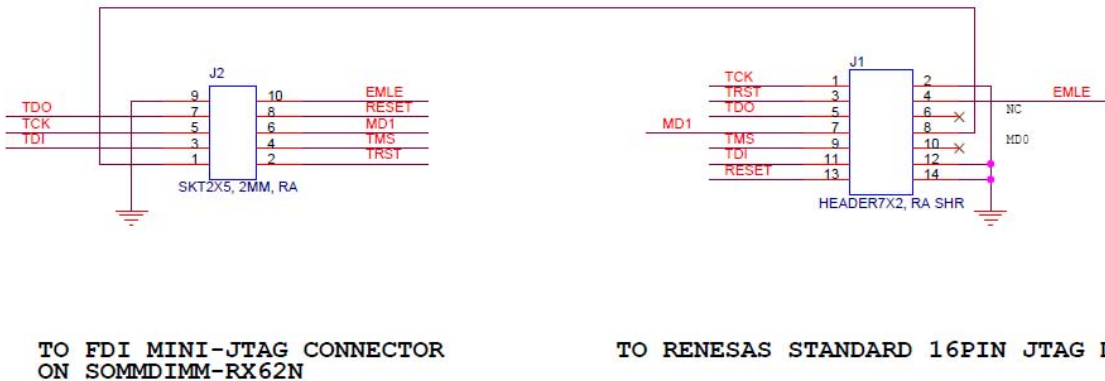

Figure 5 – Mini JTAG Adapter Wiring Diagram

MicroSD Connector – J1

The SOMDIMM-RX62N utilizes a MicroSD Socket for flexible mass storage capability. MicroSD Flash Cards are utilized by almost every cell phone on the market and are very cost effective, providing as much as 2GB of user-changeable memory storage. Adapter cards are available (and are usually included with the MicroSD) to facilitate installation of the MicroSD card into a standard SD reader. At this time, the SOMDIMM-RX62N uEZ® software does not support SDHC MicroSD Cards.

Pin Number	Description
1	NC
2	Micro SD Chip Select
3	Micro SD MOSI
4	3.3V
5	Micro SD SCLK
6	Ground
7	Micro SD MISO
8	NC

14. On Board Functions

Ethernet PHY – U4

The SOMDIMM-RX62N provides an Ethernet PHY from SMSC, LAN8720. The LAN8720 is a single chip solution for a 100BASE-TX/10BASE-T physical layer transceiver. It has support for reduced MII (RMII), and HP MDI-X auto crossover. This allows for any standard Ethernet cable to be used, even a crossover cable. The LAN8720 is fully compliant to IEEE 802.3u with support for auto-negotiation and manual selection of 10/100Mbps speed as well as full and half-duplex modes.

For detailed information, please refer to the specific data sheet for this device available from the manufacturer.

MicroSD – J1

The SOMDIMM-RX62N provides a MicroSD interface for access to a removable Flash memory. Micro Secure Digital cards are one of the lowest prices per capacity memory cards available. They allow the RX62N to have access to a much larger amount of Flash memory in a very small form factor. When using a MicroSD card it can be accessed via the SPI B bus of the RX62N. At this time, SDHC MicroSD Cards are not supported by the uEZ® software.

Reset Generator – U7

The SOMDIMM-RX62N utilizes a TPS3808 power-on reset supervisor and voltage monitor. The TPS3808 includes an external reset input that is connected to the reset button on the CARRIER Board.

For detailed information, please refer to the specific data sheet for this device available from the manufacturer.

15. 200-pin SOMDIMM Connector Details – J4

Pin	SOMDIMM Signal Name	Application Details	I/O	SOMDIMM Connection Details
1	ETH_TXP	Ethernet Transmit Positive	O	Output from LAN8720 Ethernet PHY
2	ETH_RXP	Ethernet Receive Positive	I	Output from LAN8720 Ethernet PHY
3	ETH_TXN	Ethernet Transmit Negative	O	Input to LAN8720 Ethernet PHY
4	ETH_RXN	Ethernet Receive Negative	I	Input to LAN8720 Ethernet PHY
5	3V3A	3.3V Analog	P	Analog 3.3V Output from PHY Circuit
6	GND	Ground	P	
7	ETH_LED0	Ethernet LED0	O	Ethernet LED0 output from LAN8720
8	ETH_LED1	Ethernet LED1	O	Ethernet LED1 output from LAN8720
9	NC	Not connected	U	
10	NC	Not connected	U	
11	RESET_IN	Reset Input	I	Reset input to POR IC TPS3808
12	RESET_OUT	Reset Output from POR	O	Reset output from POR circuit
13	NC	Not connected	U	
14	NC	Not connected	U	
15	NC	Not connected	U	
16	NC	Not connected	U	
17	NC	Not connected	U	
18	NC	Not connected	U	
19	NC	Not connected	U	
20	NC	Not connected	U	
21	VDDA	Vdd Analog	I	ADC Power Supply
22	VREF	Reference Voltage	I	ADC Reference Voltage Input
23	VSSA	Vss Analog	I	ADC Ground
24	GND	Ground	P	
25	GPIO25_LCDPWR	LCD Power Enable	O	Connected to Port 9 pin 2
26	GPIO26_LCDLE	Not connected	U	
27	GPIO27_LCDCLK	LCD Clock	O	Connected to Port 5 pin 6
28	GPIO28_LCDFP		O	Connected to Port 2 pin 4
29	GPIO29_LCDENABLE	LCD Enable	O	Connected to Port 3 pin 4
30	GPIO30_LCDLP		O	Connected to Port 2 pin 2
31	GPIO31_LCDVD4	LCD Data Bit 4	O	Connected to Port E pin 4
32	GPIO32_LCDVD5	LCD Data Bit 5	O	Connected to Port E pin 5
33	GPIO33_LCDVD6	LCD Data Bit 6	O	Connected to Port E pin 6
34	GPIO34_LCDVD7	LCD Data Bit 7	O	Connected to Port E pin 7
35	GPIO35	GPIO	U	Connected to Port 5 pin 2
36	GPIO36	LCD SPI CS	U	Connected to Port 5 pin 0
37	3.3V	3.3V Power	P	
38	GND	Ground	P	
39	3.3V	3.3V Power	P	
40	GND	Ground	P	
41	USBH_DP	USB Host Data Positive	B	Connected to USB1_DP
42	USBD_DP	USB Device Data Positive	B	Connected to USB0_DP
43	USBH_DM	USB Host Data Negative	B	Connected to USB1_DM -
44	USBD_DM	USB Device Data Negative	B	Connected to USB0_DP
45	GPIO45_LCDVD18	LCD Data Bit 18	O	Connected to Port D pin 4
46	GPIO46_LCDVD19	LCD Data Bit 19	O	Connected to Port D pin 0
47	NC	Not connected	U	
48	NC	Not connected	U	
49	NC	Not connected	U	
50	NC	Not connected	U	
51	GND	Ground	P	
52	GND	Ground	P	
53	GND	Ground	P	
54	GND	Ground	P	
55	GND	Ground	P	
56	GND	Ground	P	
57	GPIO57_TXD	GPIO / Serial Transmit Data	O	Connected to Port 2 pin 0
58	GPIO58_RXD	GPIO / Serial Receive Data	I	Connected to Port 2 pin 1
59	GPIO59_USBH_PWRD	GPIO / USB Host Power Detect	I	Connected to Port 0 pin 5
60	GPIO60_USBD_UPLD	GPIO / USB Device Up LED	O	Connected to Port 0 pin 0
61	GPIO61_USBD_CON	GPIO / USB Device Connect	O	Connected to Port 1 pin 4
62	GPIO62_SCK	GPIO / SPI Clock	O	Connected to Port 2 pin 7
63	NC	Not connected	U	
64	GPIO64_MISO	GPIO / SPI MISO	I	Connected to Port 3 pin 3
65	GPIO65_MOSI	GPIO / SPI MOSI	O	Connected to Port 2 pin 6

66	NC	Not connected	U	
67	NC	Not connected	U	
68	GPIO68_USBH_OVC	GPIO / USB Host Over Current	I	Connected to Port 1 pin 5
69	GPIO69_TPIRQ	GPIO / Touch IC IRQ Input	I	Connected to Port 0 pin 3
70	GPIO70_AD0.0	GPIO / AD0 Bit 0	I	Connected to Port 4 pin 6
71	GPIO71_AD0.1	GPIO / AD0 Bit 1	I	Connected to Port 4 pin 5
72	GPIO72_AD0.2	GPIO / AD0 Bit 2	I	Connected to Port 4 pin 4
73	GPIO73_AD0.3	GPIO / AD0 Bit 3	I	Connected to Port 4 pin 7
74	GPIO74_SDA	GPIO / User IO I2C Bus SDA	B	Connected to Port 1 pin 3
75	GPIO75_SCL	GPIO / User IO I2C Bus SCL	O	Connected to Port 1 pin 2
76	GND	Ground	P	
77	GND	Ground	P	
78	GPIO78_ACC_IRQ	GPIO / Accelerometer IRQ	I	Connected to Port 0 pin 2
79	NC	Not connected	U	
80	GPIO80_RTC_IRQ	GPIO / RTC IRQ Input	I	Connected to Port 1 pin 0
81	NC	Not connected	U	
82	NC	Not connected	U	
83	NC	Not connected	U	
84	NC	Not connected	U	
85	NC	Not connected	U	
86	GPIO86_LED_BR	GPIO / LED Backlight Bright	O	Connected to Port 9 pin 3
87	GPIO87_USBH_PPWR	GPIO / USB Host Power Ctl	O	Connected to Port 1 pin 7
88	GPIO88_LCDVD10	LCD Data Bit 10	O	Connected to Port D pin 5
89	GPIO89_LCDVD11	LCD Data Bit 11	O	Connected to Port D pin 6
90	GPIO90_LCDVD12	LCD Data Bit 12	O	Connected to Port D pin 7
91	GPIO91_LCDVD13	LCD Data Bit 13	O	Connected to Port E pin 0
92	GPIO92_LCDVD14	LCD Data Bit 14	O	Connected to Port E pin 1
93	GPIO93_LCDVD15	LCD Data Bit 15	O	Connected to Port E pin 2
94	GPIO94_LCDVD20	LCD Data Bit 16	O	Connected to Port E pin 3
95	GPIO95_LCDVD21	LCD Data Bit 17	O	Connected to Port E pin 4
96	GPIO96_LCDVD22	LCD Data Bit 22	O	Connected to Port E pin 5
97	GPIO97_LCDVD23	LCD Data Bit 23	O	Connected to Port E pin 6
98	GPIO98_USBD_VBUS	USB Device VBus Sense Input	I	Connected to Port 1 pin 6
99	NC	Not connected	U	
100	NC	Not connected	U	
101	GND	Ground	P	
102	GND	Ground	P	
103	NC	Not connected	U	
104	NC	Not connected	U	
105	NC	Not connected	U	
106	NC	Not connected	U	
107	NC	Not connected	U	
108	NC	Not connected	U	
109	NC	Not connected	U	
110	NC	Not connected	U	
111	NC	Not connected	U	
112	NC	Not connected	U	
113	NC	Not connected	U	
114	NC	Not connected	U	
115	NC	Not connected	U	
116	GPIO116	GPIO	B	Connected to Port 9 pin 7
117	GPIO117	GPIO	B	Connected to Port 9 pin 6
118	GPIO118	GPIO	B	Connected to Port G pin 1
119	GPIO119	GPIO	B	Connected to Port G pin 0
120	P57_WAIT#-A	GPIO	B	Connected to Port 5 pin 7
121	P53_BCLK	GPIO	B	Connected to Port 5 pin 3
122	NC	Not connected	U	2
123	GPIO123_SPKR	GPIO	O	
124	P11_SCK2-A	GPIO	B	Connected to Port 1 pin 1
125	P60_CS0#-A	GPIO	B	Connected to Port 6 pin 0
126	P73_CS3#-B	GPIO	B	Connected to Port 7 pin 3
127	GPIO127_LCDVD2	LCD Data Bit 2	O	Connected to Port E pin 7
128	GPIO128_LCDVD3	LCD Data Bit 3	O	Connected to Port E pin 3
129	GND	Ground	P	
130	GND	Ground	P	
131	PC7_ET_COL_MTIC11U-A	GPIO	B	Connected to Port C pin 7
132	PC6_A22-A_ET_ETXD3_MTIC11V	GPIO	B	Connected to Port C pin 6

133	PC5_A21-A_ET_ETXD2_MTIC11W-A	GPIO	B	Connected to Port C pin 5
134	PC4_A20-A_ET_TX_CLK	GPIO	B	Connected to Port C pin 4
135	PC3_A19-A_ET_TC_ER_MTCLKF-A	GPIO	B	Connected to Port C pin 3
136	PC2_A18-A_ET_RX_DV_MTCLKE-A	GPIO	B	Connected to Port C pin 2
137	PC1_A17-A_ET_ERXD2	GPIO	B	Connected to Port C pin 1
138	PC0_A16-A_ET_ERXD3	GPIO	B	Connected to Port C pin 0
139	NC	Not connected	U	
140	NC	Not connected	U	
141	P43/AN3	GPIO	B	Connected to Port 4 pin 3
142	P42/AN2	GPIO	B	Connected to Port 4 pin 2
143	P41/AN1	GPIO	B	Connected to Port 4 pin 1
144	P40/ANO	GPIO	B	Connected to Port 4 pin 0
145	NC	Not connected	U	
146	P25_USB0_DPRPD_MTCLKB-A	GPIO	B	Connected to Port 2 pin 5
147	P23_USB0_DPUPE-A	GPIO	B	Connected to Port 2 pin 3
148	P22_USB0_DPRD_TMOO	GPIO	B	Connected to Port 2 pin 2
149	GPIO149_RX	GPIO	B	Connected to Port 0 pin 1
150	GPIO150_TX	GPIO	B	Connected to Port 0 pin 0
151	NC	Not connected	U	
152	NC	Not connected	U	
153	NC	Not connected	U	
154	NC	Not connected	U	
155	NC	Not connected	U	
156	NC	Not connected	U	
157	NC	Not connected	U	
158	NC	Not connected	U	
159	NC	Not connected	U	
160	NC	Not connected	U	
161	NC	Not connected	U	
162	NC	Not connected	U	
163	GND	Ground	P	
164	GND	Ground	P	
165	3.3V	3.3V Power	P	
166	GND	Ground	P	
167	NC	Not connected	U	
168	NC	Not connected	U	
169	NC	Not connected	U	
170	NC	Not connected	U	
171	NC	Not connected	U	
172	NC	Not connected	U	
173	NC	Not connected	U	
174	NC	Not connected	U	
175	NC	Not connected	U	
176	NC	Not connected	U	
177	NC	Not connected	U	
178	NC	Not connected	U	
179	NC	Not connected	U	
180	NC	Not connected	U	
181	NC	Not connected	U	
182	NC	Not connected	U	
183	NC	Not connected	U	
184	NC	Not connected	U	
185	NC	Not connected	U	
186	NC	Not connected	U	
187	NC	Not connected	U	
188	NC	Not connected	U	
189	NC	Not connected	U	
190	NC	Not connected	U	
191	NC	Not connected	U	
192	NC	Not connected	U	
193	NC	Not connected	U	
194	NC	Not connected	U	
195	NC	Not connected	U	
196	NC	Not connected	U	
197	NC	Not connected	U	
198	NC	Not connected	U	

199	3.3V	3.3V Power	P	
200	GND	Ground	P	

16. SOMDIMM Installation

The SOMDIMM-RX62N should be inserted into the DIMM Socket as shown below and then locked into place by pushing down to the Carrier Board. Ensure the SOMDIMM is inserted completely into the socket prior to locking. The socket utilized on the CARRIER Board is rated for a minimum of 25 insertions.

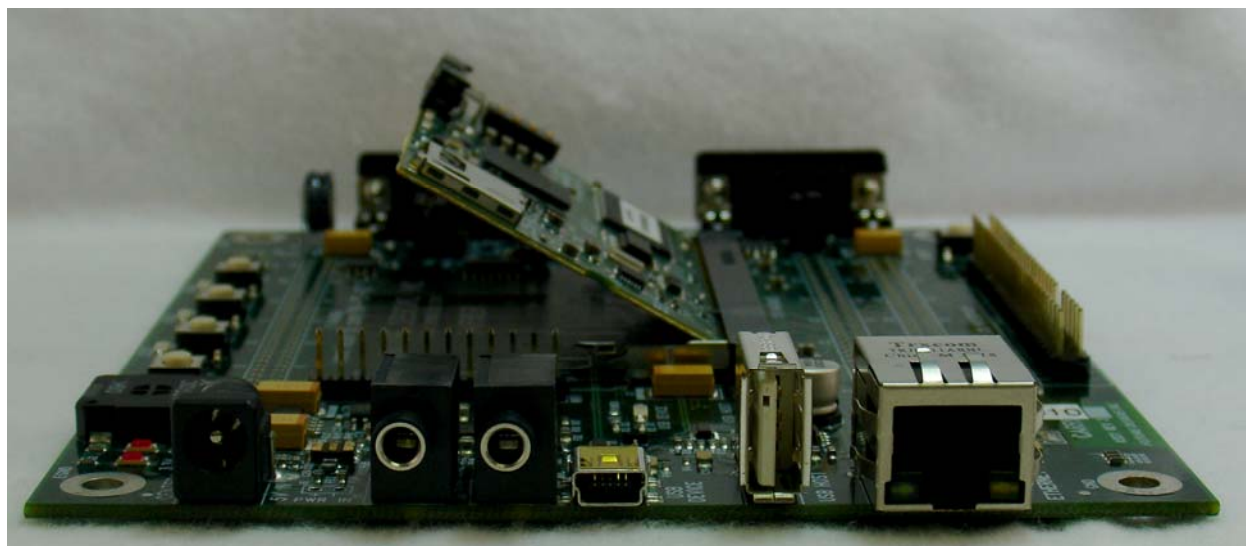

Figure 6 – SOMDIMM Insertion

17. SOMDIMM Socket Details

The SOMDIMM-RX62N is designed to be used with a standard 200-pin DDR2 SO-DIMM Socket connector. An example connector part is as follows: Mfg: Tyco (AMP), Part Number: 1473005-4.

19. Software

μ EZ[®] takes its name from the Muses of Greek mythology. A Muse was a goddess who inspired the creation process for the arts and sciences. Like its ancient Greek namesake, the μ EZ[®] platform inspires rapid development by supplying customers with an extensive library of open source software, drivers, and processor support - all under a common framework. μ EZ[®] development works on the premise of "design once, reuse many times". This provides an open source standard for embedded developers to build upon and support. μ EZ[®] allows companies to focus on innovation and on their own value-added applications while minimizing development time and maximizing software reuse.

The diagram below shows a typical embedded application stack. μ EZ[®] has three primary categories of components that help simplify embedded application development:

1. **Operating System Abstraction Layer (μ EZ[®] OSAL)**
2. **Sub-system drivers (μ EZ[®] TCP/IP, μ EZ[®] USB, μ EZ[®] Driver)**
3. **Hardware Abstraction Layer (μ EZ[®] HAL)**

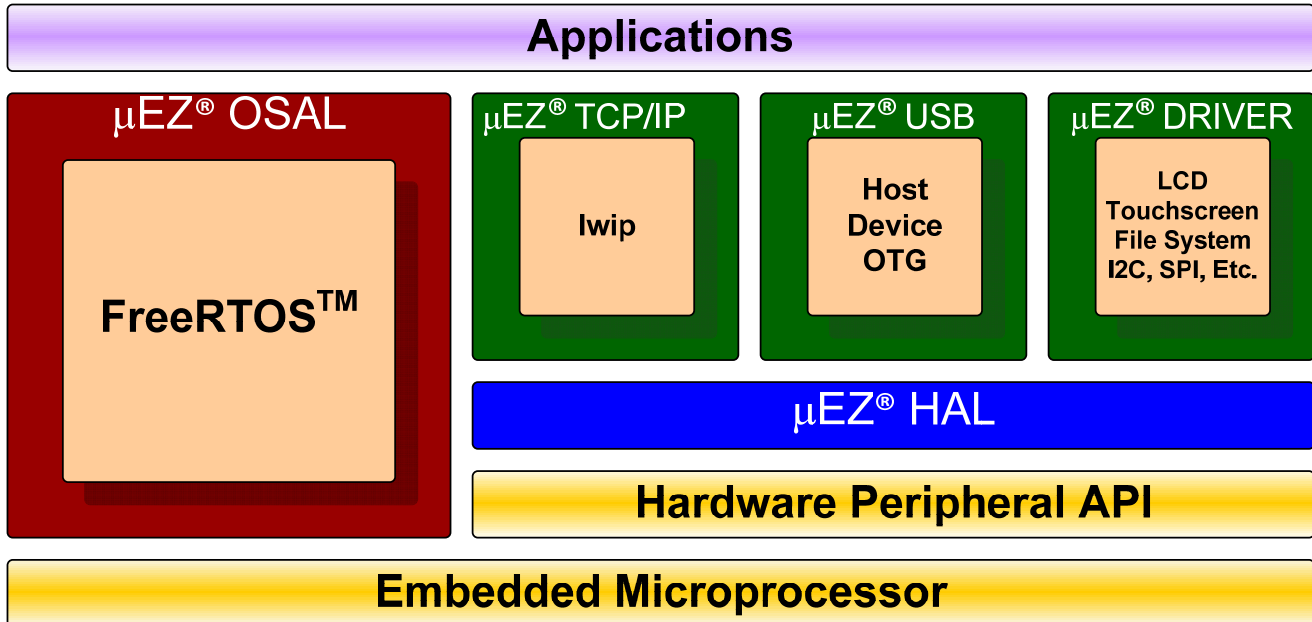

The selection of an RTOS can be one of the most daunting aspects of an embedded system development. With μ EZ[®] the primary features of common multi-tasking operating systems are abstracted, thus easing the transition to an open source or low-cost RTOS. The μ EZ[®] OSAL provides applications access to the following features in an OS-independent fashion:

- Pre-emptive multitasking
- Stack overflow detection
- Unlimited number of tasks
- Queues
- Semaphores (binary, counting, mutex)

The μ EZ[®] sub-system drivers utilize the OSAL functions to provide protected access to the processor peripherals. The sub-system driver API functions are typically protocol layer interfaces (TCP/IP, USB, etc) designed as high-level access routines such as open, close, read, write, etc. where possible.

The HAL functions provide single-threaded unprotected access to the processor peripherals. Customers can use the **μEZ**[®] HAL routines provided by FDI or they can write their own. The HAL routines provide for RTOS/**μEZ**[®] independence and allow portability within a family of processors.

μEZ[®] is ideally suited for Embedded Systems with standard features such as:

- Processor and Platform BSPs
(Board Support Packages)
- Real Time Operating System (RTOS)
- Memory Management
- NAND/NOR Flash
- SDRAM and DDR Memory
- TCP/IP stack
- Mass Storage Devices
- LCD Displays with Touch Screen
- Input / Output Devices

20. Configuring Renesas HEW for J-Link Flashing

- 1) See the document “uEZ® Software Quick start Guide” for details on how to download the uEZ® source code
- 2) Plug in the J-Link device into the PC and install any drivers as directed. If necessary, download the drivers from http://www.segger.com/cms/jlink-software.html?step=1&file=JLink_426a
- 3) Plug in the J-Link’s JTAG 10-pin connector (J2) to the SOMDIMM board connector (CN1) with the JTAG adapter.
- 4) If a workspace has not been opened, go to /uEZ_SRC/Build/DK-TS-KIT/DK-57TS-RX62N/RenesasRX and open file “DKTSKITDemo_RX62N.hws” or any other existing workspace.
- 5) Build the code if not already using **Build->Build** or by pressing **F7**.
- 6) Open Debug->Debug Sessions. Under Current Session, select “SessionRX600_Segger_J-Link” and click **OK**. Some older compiler configurations do not have this option. If this is the case, use “SessionRX600_E1_E20_SYSTEM”. If asked to save the previous session, click **No**.

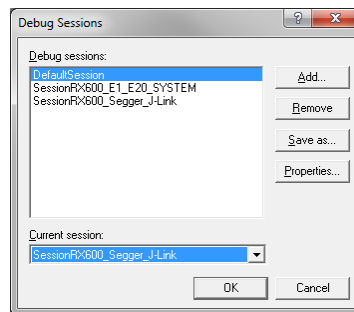

- 7) The following dialog will appear. Make sure the MCU group is “RX62N Group” and Device is “R5F562N8”. On the Communication tab, the JTAG Clock is 16.5 MHz. Press **OK**.

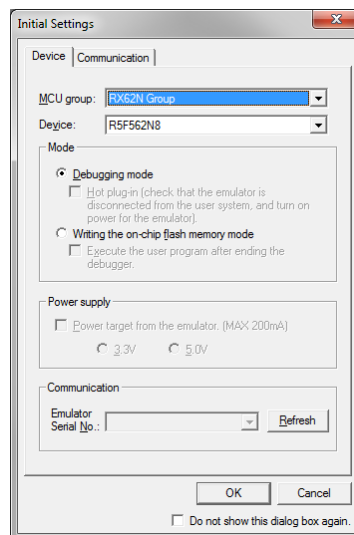

- 8) The Configuration Properties will appear. Confirm the Operating Mode has a Mode of “Single-chip mode” and Input clock (EXTAL) is “12.0000” MHz. The other tabs (Internal flash memory, External Flash memory, and System) use the default values. Then press **OK** to connect to the unit.

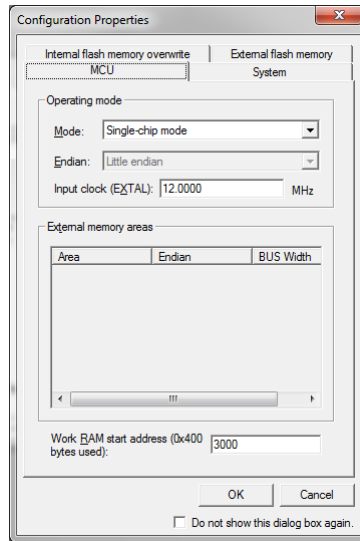

- 9) No errors should appear. The unit is now connected. The next step is to download the code. If the code has been compiled, scroll down in the project explorer and find the image file under “Download modules”. For the DKTSKitDemo code, the file “DKTSKITDemo_RX62N.abs” should be listed. Right click on this file and select **Download**.

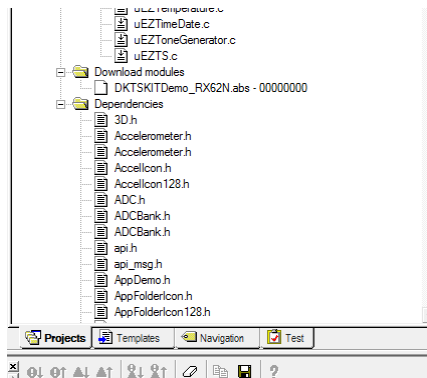

10) The following window should appear. Select Debug->Run (F5) to start execution.

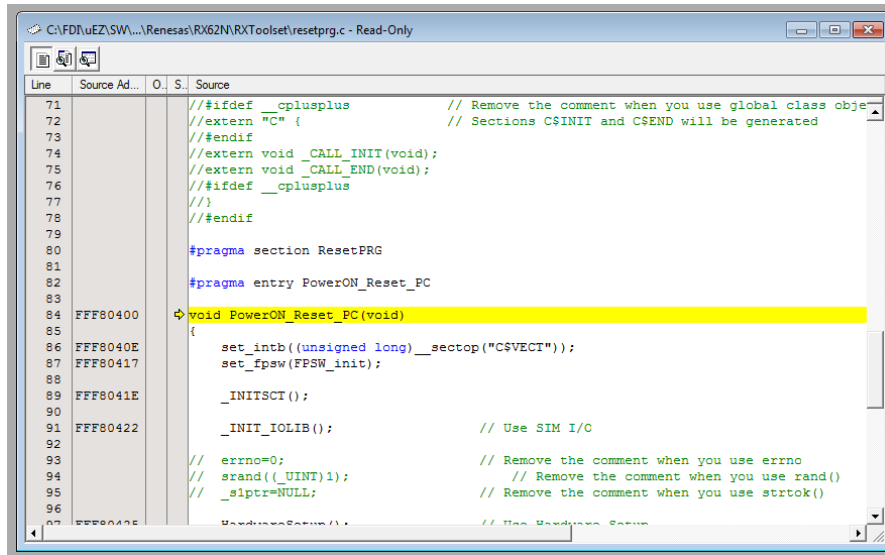

The screenshot shows a code editor window titled "C:\FD\nuEZ\SW\...\Renesas\RX62N\RXToolset\resetprg.c - Read-Only". The code is as follows:

```
71 // #ifndef __cplusplus // Remove the comment when you use global class objects
72 // extern "C" { // Sections C$INIT and C$END will be generated
73 // #endif
74 // extern void _CALL_INIT(void);
75 // extern void _CALL_END(void);
76 // #ifdef __cplusplus
77 // }
78 // #endif
79
80 #pragma section ResetPRG
81
82 #pragma entry PowerON_Reset_PC
83
84 void PowerON_Reset_PC(void)
85 {
86     set_intb((unsigned long)_sectop("C$VECT"));
87     set_fpw(FPSW_init);
88
89     _INITSCT();
90
91     _INIT_IOLIB(); // Use SIM I/O
92
93     // errno=0; // Remove the comment when you use errno
94     // srand((UINT)1); // Remove the comment when you use rand()
95     // _s1ptr=NULL; // Remove the comment when you use strtok()
96
97     HardwareSetup(); // Use Hardware Setup
```

21. Functional Test Software

The functional test software tests all the features of the DK-TS-KIT. Additional hardware is required to test all the features, but these additional tests can be bypassed if the necessary hardware is not available.

Configuring the Functional Test setup

Another DK-TS-KIT is required for complete functional testing. By connecting to another kit's serial and CAN port, the functional test can receive automatic responses for specific queries. The DK-TS-KIT only needs a version of firmware that has the FCT Loopback program. This document will refer to this second unit as the "loopback unit".

Start with a CARRIER board that is already connected as described above, but disconnect the PC to serial connection. Connect a null modem cable between the CARRIER RS232 port (P4) and the loopback unit's RS232 port (also P4). NOTE: A gender change may be required. Then connect a DB9 cable between the CARRIER CAN port (P3) and loopback unit's CAN port (also P3). Power will be provided to the loopback unit from the CARRIER CAN port. When the unit boots up, select **Settings** and then **FCT Loopback**. You are now ready to do the functional test.

Running Functional Test

From the Main Menu, select Settings and then **Functional Test** to start the test. To abort the functional test, PRESS and HOLD the **Cancel** button. If the current test cannot be performed, press **Skip** to go to the next test. Most tests will run automatically and will report a green "Pass" or red "Fail" output. Some tests will require user input in the form of a question and a **Yes** or **No** response. If a test fails, the functional test will pause to show the error – press **OK** to continue.

The following tests are performed:

- SDRAM – Memory is sized and a basic test is performed to confirm read/write access.
- LCD Colors – Red, Green, and Blue are displayed in smooth bands to ensure the LCD lines are correct.
- External RTC – The CARRIER board has an external NXP I2C PCF8563 Real Time Clock that is set to 1/1/2009, 8:00:00 and then sampled for 3 seconds to verify that it is operational.
- Temperature Sensor – The CARRIER board has an external LM75A that is tested to be in a range of 20-30 C.
- Serial Port – A serial command is sent to the loopback unit and a response detected.
- Micro SDCard – A FAT formatted Micro SDCard that is inserted into the SOMDIMM-LPC2478 J2 slot is read to verify that the file TESTSDC.TXT is correct. (SDHC not supported)
- LEDs and Buttons – All four LEDs (LED1 to LED4) on the CARRIER board are lit by pressing the push button switches SW1 to SW4.
- Speaker – Tunes are played and the User is asked to verify that they are heard.
- Ethernet – Waits for a web page hit at <http://192.168.10.20/>

A final report of PASS or FAIL is displayed along with a list of any Skipped and Failed items.

22. Schematics

Please see the website at:

<http://www.teamfdi.com/SOMDIMM-RX62N>

23. Table of Figures

Figure 1 – RX62N SOMDIMM Block Diagram.....	4
Figure 2 – SOMDIMM-RX62N Side.....	11
Figure 3 – SOMDIMM-RX62N Bottom Side.....	11
Figure 4 – DK-TS-KIT System Block Diagram	12
Figure 5 – Mini JTAG Adapter Wiring Diagram	13
Figure 6 – SOMDIMM Insertion	19
Figure 7 – SOMDIMM-RX62N Mechanical Details	20