

# MAX149X2 Evaluation Kit

Evaluates: MAX14940/MAX14943/  
MAX14946/MAX14949

## General Description

The MAX149X2 evaluation kit (EV kit) is a fully assembled and tested PCB that demonstrates the functionality of the MAX14943 isolated RS-485/PROFIBUS transceiver. The EV kit operates from a single 3.3V supply and features an on-board isolated power supply to power the secondary-side of the circuit.

The MAX149X2 EV kit comes with the MAX14943GWE+ installed, but can also be used to evaluate the pin-compatible MAX14940, MAX14946, and MAX14949 ICs.

## Features

- Operates from a Single 3.3V Supply
- Terminal Block Connectors for Easy RS-485/PROFIBUS Evaluation
- 5000V<sub>RMS</sub> Isolation for 60s
- Fully Assembled and Tested
- Proven PCB Layout

*Ordering Information appears at end of data sheet.*

## Quick Start

### Required Equipment

- MAX149X2 EV kit
- 3.3V, 1A DC power supply
- Signal/function generator
- Oscilloscope

### Startup Procedure

The EV kit is fully assembled and tested. Follow the steps below to verify board operation:

- 1) Set the DC power supply to 3.3V and connect the DC power supply between the EV kits VDDA and GNDA connectors of the EV kit.
- 2) Ensure that J2 and J3 are in their default positions (see [Table 1](#)).
- 3) Turn on the power supply.
- 4) Set the signal/function generator to output a 100kHz 0 to 3V square wave. Note: Set the signal/function generator to operate with a high-impedance load. If needed, the R1 pad is available to add a 50Ω impedance to ground.
- 5) Connect the signal/function generator to the TXD test point.
- 6) Verify that the A and B outputs switch as the signal toggles.

**Table 1. Jumper Settings (J1–J6)**

JUMPER	SHUNT POSITION	DESCRIPTION
J1	1-2	Receiver is disabled. RXD is high impedance.
	2-3*	Receiver is enabled. RXD is active.
J2	1-2*	Driver is enabled. DEM is high.
	2-3	Driver is disabled. DEM is low.
J3	Open*	DE and $\overline{RE}$ are not connected together.
	Closed	DE and $\overline{RE}$ are connected together.
J4	Open*	A and B are not connected through the on-board 120Ω resistor.
	Closed	Connects the on-board 120Ω resistor between A and B.

\*Default position.



### Detailed Description of Hardware

The MAX149X2 EV kit is a fully assembled and tested circuit board for evaluating the MAX14943 isolated RS-485/Profibus transceiver (U1). The EV kit has been designed to allow for evaluating the IC alone or in a standard RS-485 configuration. The EV kit is powered from a single 3.3V power supply.

#### External Power Supply

The power on the EV kit is derived from a single 3.3V source. Connect an external supply from GNDA to either the VDDA test point or P1 connector to supply the 3.3V to the logic side (A) of the circuit. The integrated push-pull transformer driver and external transformer (TX1) generate an isolated supply for powering the (B) isolated side of the board.

#### Evaluating the Isolated RS-485 Interface

##### Driver and Receiver Enable Selection

The EV kit features three jumpers (J1, J2, and J3) to enable/disable the driver and receiver outputs. Set J1 to 2-3 to enable the receiver. Set J2 to 1-2 to enable the driver. To actively control both enables, remove J1 and J2 and close J3, which connects DE and RE together.

#### Resistors R2 – R4 Configuration

For end-of-the-line transceivers, close J4 to connect a 120Ω resistor (R3) between the A and B RS-485 I/Os on the IC.

Pullup and pulldown resistors are generally used on the receiver inputs to guarantee a known state in the event that all nodes on the bus are in receive mode, or the cable becomes disconnected. The exact value for these resistors varies with the application. Pads are provided for pullup (R2) and pulldown (R4) resistors for the A-B lines, although the use of these resistors is purely optional. Note that the MAX14943 features true fail-safe receiver inputs that ensure RXD is high when the receiver inputs are shorted, open, or connected to an idle bus.

#### Selecting a Transformer

[Table 2](#) is a list of transformers designed to operate with the device family. Select the transformer that best meets the performance requirements of the end application. All transformers in [Table 2](#) can be used on the EV kit.

**Table 2. Transformer Selection**

MANUFACTURER/PART NUMBER	TURNS RATIO	ISOLATION VOLTAGE (V <sub>RMS</sub> )	A-SIDE SUPPLY (V)	CAN BE USED WITH MAXIM PART NUMBERS
HALO TGMS-1440V6LF	1CT: 1.33CT	2750	5V	MAX14940, MAX14946
HALO TGMS-1464V6LF	1CT:2.4CT	2750	3.3V	MAX14940, MAX14946
HALO TGMR-1440V6LF	1CT:1.33CT	5000	5V	MAX14943, MAX14949
HALO TGMR-1464V6LF	1CT:2.4CT	5000	3.3V	MAX14943, MAX14949
WURTH 750315226	1CT:1.3CT	2750	5V	MAX14940, MAX14946
WURTH 750315228	1CT: 2CT	2750	3.3V	MAX14940, MAX14946
WURTH 750315230	1CT:1.3CT	5000	5V	MAX14943, MAX14949
WURTH 750315232	1CT: 2CT	5000	3.3V	MAX14943, MAX14949

---

## MAX149X2 Evaluation Kit

Evaluates: MAX14940/MAX14943/  
MAX14946/MAX14949

### Component List, PCB Layout, and Schematic

See the following links for component information, PCB layout diagrams, and schematics:

- [MAX149X2 EV BOM](#)
- [MAX149X2 EV PCB Layout](#)
- [MAX149X2 EV Schematic](#)

### Ordering Information

PART	TYPE
MAX149X2EVKIT#	EV Kit

#Denotes RoHS compliant.

### Revision History

REVISION NUMBER	REVISION DATE	DESCRIPTION	PAGES CHANGED
0	6/15	Initial release	—

For pricing, delivery, and ordering information, please contact Maxim Direct at 1-888-629-4642, or visit Maxim Integrated's website at [www.maximintegrated.com](http://www.maximintegrated.com).

*Maxim Integrated cannot assume responsibility for use of any circuitry other than circuitry entirely embodied in a Maxim Integrated product. No circuit patent licenses are implied. Maxim Integrated reserves the right to change the circuitry and specifications without notice at any time.*

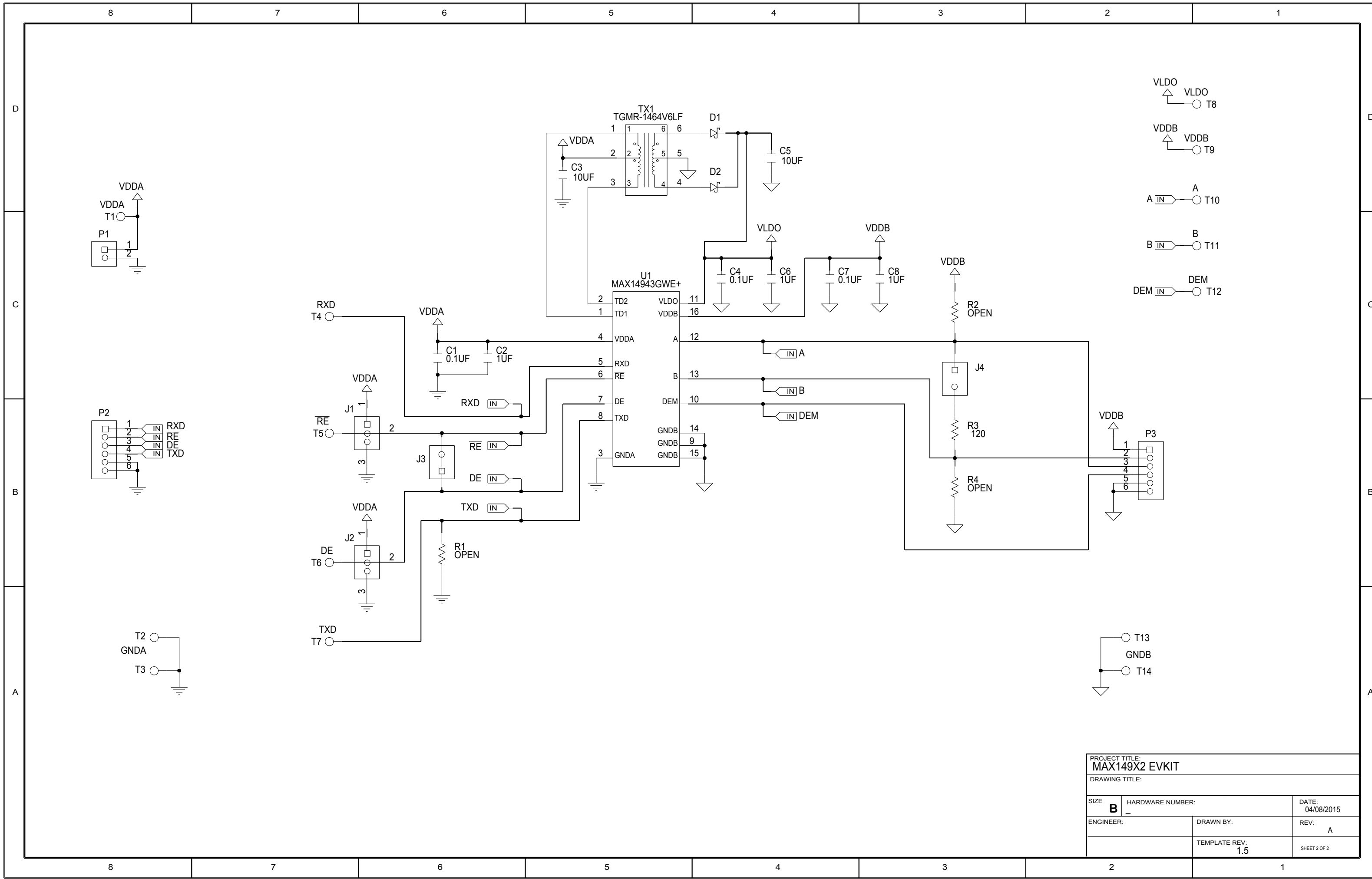

PROJECT TITLE: <b>MAX149X2 EVKIT</b>		
DRAWING TITLE:		
SIZE <b>B</b>	HARDWARE NUMBER: -	DATE: 04/08/2015
ENGINEER:	DRAWN BY:	REV: A
	TEMPLATE REV: 1.5	SHEET 2 OF 2



This document contains information considered proprietary, and shall not be reproduced wholly or in part, nor disclosed to others without specific written permission.

HARDWARE NAME: MAX149X2\_EVKIT\_A

HARDWARE NUMBER:

ENGINEER:

DESIGNER:

DATE: 04/08/2015

ODB++/GERBER: SILK\_TOP

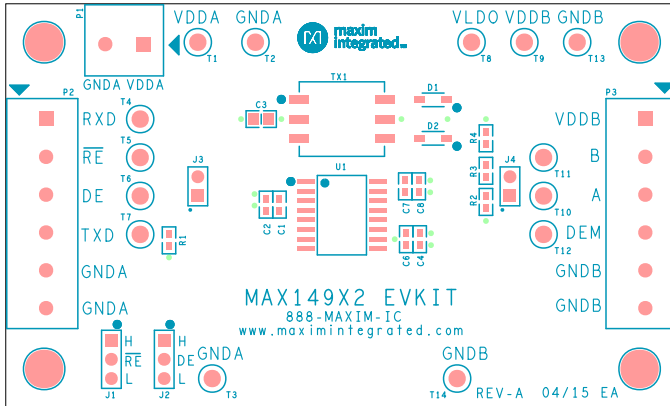



This document contains information considered proprietary, and shall not be reproduced wholly or in part, nor disclosed to others without specific written permission.

HARDWARE NAME: MAX149X2\_EVKIT\_A

HARDWARE NUMBER:

ENGINEER:

DESIGNER:

DATE: 04/08/2015

ODB++/GERBER: TOP

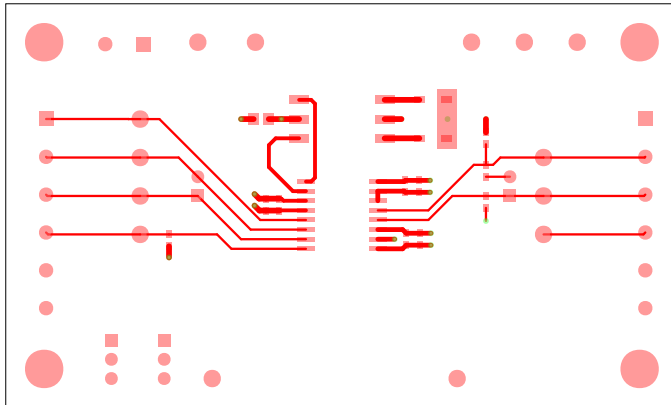



This document contains information considered proprietary, and shall not be reproduced wholly or in part, nor disclosed to others without specific written permission.

HARDWARE NAME: MAX149X2\_EVKIT\_A

HARDWARE NUMBER:

ENGINEER:

DESIGNER:

DATE: 04/08/2015

ODB++/GERBER: INTERNAL 2

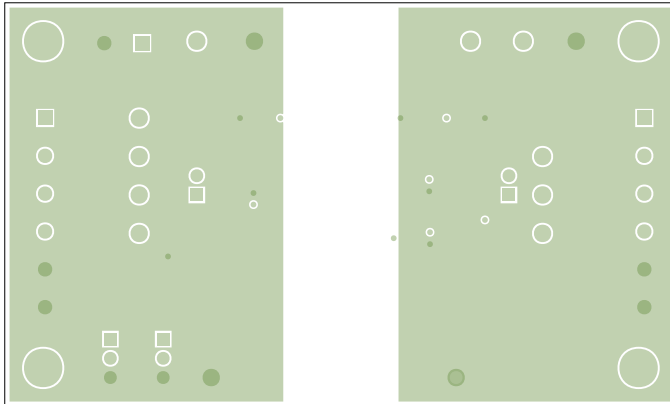





This document contains information considered proprietary, and shall not be reproduced wholly or in part, nor disclosed to others without specific written permission.

HARDWARE NAME: MAX149X2\_EVKIT\_A

HARDWARE NUMBER:

ENGINEER:

DESIGNER:

DATE: 04/08/2015

ODB++/GERBER: INTERNAL 3

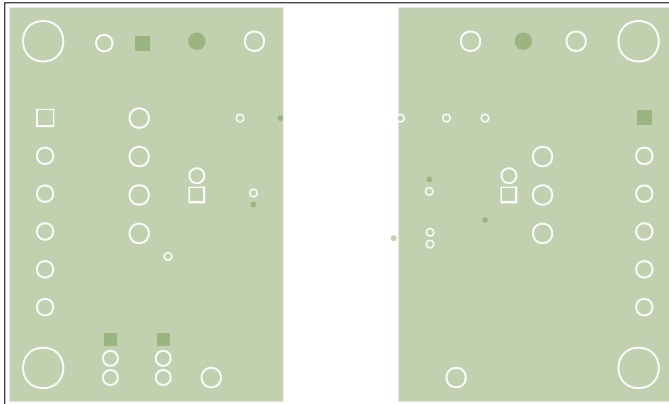



This document contains information considered proprietary, and shall not be reproduced wholly or in part, nor disclosed to others without specific written permission.

HARDWARE NAME: MAX149X2\_EVKIT\_A

HARDWARE NUMBER:

ENGINEER:

DESIGNER:

DATE: 04/08/2015

ODB++/GERBER: BOTTOM

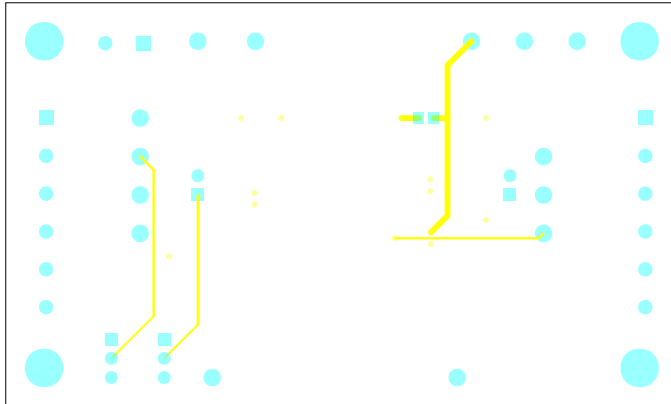



This document contains information considered proprietary, and shall not be reproduced wholly or in part, nor disclosed to others without specific written permission.

HARDWARE NAME: MAX149X2\_EVKIT\_A

HARDWARE NUMBER:

ENGINEER:

DESIGNER:

DATE: 04/08/2015

ODB++/GERBER: SILK\_BOT

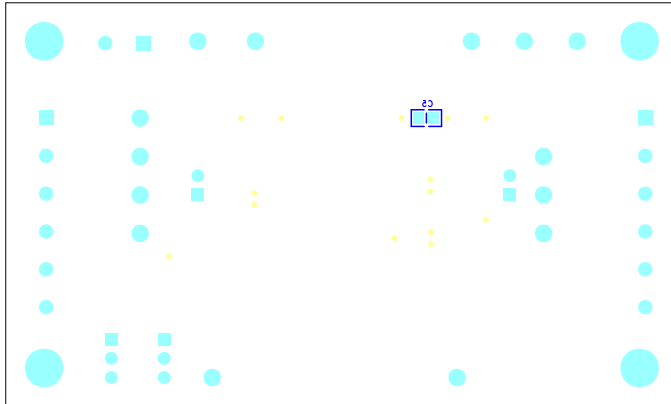

TITLE: Bill of Materials
DATE: 04/08/2015
DESIGN: max149x2_evkit_a

ITEM	QTY	REF DES	MFG PART #	MANUFACTURER	VALUE	DESCRIPTION
1	2	C1, C7	C0603C104K4RAC; GCM188R71C104KA37; C1608X7R1C104K; GRM188R71C104K; C0603X7R160-104KNE	KEMET/MURATA/T DK/VENKEL LTD.	0.1UF	CAPACITOR; SMT (0603); CERAMIC CHIP; 0.1UF; 16V; TOL=10%; TG=-55 DEGC TO +125 DEGC; TC=X7R; NOT RECOMMENDED FOR NEW DESIGN USE 20-000u1-01
2	3	C2, C6, C8	GRM188R71E105KA12D; CGA3E1X7R1E105K	MURATA	1UF	CAPACITOR; SMT (0603); CERAMIC CHIP; 1UF; 25V; TOL=10%; MODEL=GRM SERIES; TG=-55 DEGC TO +125 DEGC; TC=X7R
3	2	C3, C5	GRM21BR61E106K; C2012X5R1E106K125AB; C2012X5R1E106K	MURATA/TDK	10UF	CAPACITOR; SMT (0805); CERAMIC CHIP; 10UF; 25V; TOL=10%; MODEL=; TG=-55 DEGC TO +125 DEGC; TC=X5R
4	1	C4	C0603C104K3RAC; GRM188R71E104KA01; C1608X7R1E104K	KEMET/MURATA/T DK	0.1UF	CAPACITOR; SMT; 0603; CERAMIC; 0.1uF; 25V; 10%; X7R; -55degC to + 125degC; +/-15% from - 55degC to +125degC; NOT RECOMMENDED FOR NEW DESIGN USE - 20-000u1-01
5	2	D1, D2	MBR0520	GENERIC PART	MBR0520	DIODE; SCH; SCHOTTKY RECTIFIER; SMT (SOD- 123); PIV=20V; IF=0.5A; -55 DEGC TO +150 DEGC
6	2	J1, J2	PEC03SAAN	SULLINS	PEC03SAAN	CONNECTOR; MALE; THROUGH HOLE; BREAKAWAY; STRAIGHT; 3PINS
7	2	J3, J4	PEC02SAAN	SULLINS	PEC02SAAN	CONNECTOR; MALE; THROUGH HOLE; BREAKAWAY; STRAIGHT; 2PINS
8	1	P1	1935161	PHOENIX CONTACT	1935161	CONNECTOR; FEMALE; THROUGH HOLE; GREEN TERMINAL BLOCK; STRAIGHT; 2PINS
9	2	P2, P3	1935200	PHOENIX CONTACT	1935200	CONNECTOR; FEMALE; THROUGH HOLE; GREEN TERMINAL BLOCK; STRAIGHT; 6PINS
10	1	R3	CRCW0603120RJN	VISHAY DALE	120	RESISTOR; 0603; 120 OHM; 5%; 200PPM; 0.10W; THICK FILM
11	2	SU1, SU2	STC02SYAN	SULLINS ELECTRONICS CORP.	STC02SYAN	TEST POINT; JUMPER; STR; TOTAL LENGTH=0.256IN; BLACK; INSULATION=PBT CONTACT=PHOSPHOR BRONZE; COPPER PLATED TIN OVERALL
12	3	T1, T8, T9	5010	?	5010	TESTPOINT WITH 1.80MM HOLE DIA, RED, MULTIPURPOSE
13	4	T2, T3, T13, T14	5011	?	5011	TEST POINT; PIN DIA=0.125IN; TOTAL LENGTH=0.445IN; BOARD HOLE=0.063IN; BLACK; PHOSPHOR BRONZE WIRE SILVER PLATE FINISH; RECOMMENDED FOR BOARD THICKNESS=0.062IN
14	7	T4-T7, T10-T12	5014	?	5014	TEST POINT; PIN DIA=0.125IN; TOTAL LENGTH=0.445IN; BOARD HOLE=0.063IN; YELLOW; PHOSPHOR BRONZE WIRE SILVER PLATE FINISH; RECOMMENDED FOR BOARD THICKNESS=0.062IN
15	1	TX1	TGMR-1464V6LF	HALO ELECTRONICS, INC	TGMR- 1464V6LF	TRANSFORMER; SMT; 1:2.4; POWER TRANSFORMER; DRAFT DATASHEET ONLY

16	1	U1	MAX14943GWE+	MAXIM	MAX14943GWE+	EVKIT PART-IC; PACKAGE CODE: W16M-9; OUTLINE DRAWING NO.: 21-0042; LAND PATTERN DRAWING NO.: 90-0107; WSOIC16 300MIL
17	1		MAX149x2	MAXIM	PCB	PCB: MAX149x2
TOTAL	37					

DO NOT PURCHASE(DNP)

ITEM	QTY	REF DES	MFG PART #	MANUFACTURER	VALUE	DESCRIPTION
1	3	R1, R2, R4	N/A	N/A	OPEN	PACKAGE OUTLINE 0603 RESISTOR - EVKIT
TOTAL	3					