

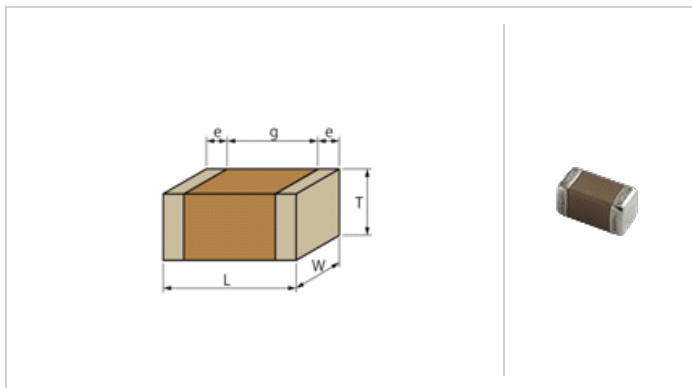

Date of discontinuation: 31 Mar 2014

< List of part numbers with package codes >
GRM2165C1H2R2CD01D , GRM2165C1H2R2CD01J

Shape



L size	2.0 ±0.1mm
W size	1.25 ±0.1 mm
T size	0.6 ±0.1mm
External terminal width e	0.2 to 0.7mm
Distance between external terminals g	0.7mm min.
Size code in inch(mm)	0805 (2012M)

Notes

Please use replacements or Recommended.

References

Packaging	Specifications	Minimum quantity
D	φ180mm Paper taping	4000
J	φ330mm Paper taping	10000

Specifications

Capacitance	2.2pF ±0.25pF
Rated voltage	50Vdc
Temperature characteristics (complied standard)	C0G(EIA)
Temperature coefficient	0±30ppm/°C
Temperature range of temperature characteristics	25 to 125°C
Operating temperature range	-55 to 125°C

Attention

- 1.This datasheet is downloaded from the website of Murata Manufacturing Co., Ltd. Therefore, it's specifications are subject to change or our products in it may be discontinued without advance notice. Please check with our sales representatives or product engineers before ordering.
- 2.This datasheet has only typical specifications because there is no space for detailed specifications. Therefore, please review our product specifications or consult the approval sheet for product specifications before ordering.