

BF1208

Dual N-channel dual gate MOSFET

Rev. 2 — 7 September 2011

Product data sheet

1. Product profile

1.1 General description

The BF1208 is a combination of two dual gate MOSFET amplifiers with shared source and gate2 leads and an integrated switch. The integrated switch is operated by the gate1 bias of amplifier B.

The source and substrate are interconnected. Internal bias circuits enable DC stabilization and a very good cross-modulation performance during Automatic Gain Control (AGC). Integrated diodes between the gates and source protect against excessive input voltage surges. The transistor has a SOT666 micro-miniature plastic package.

CAUTION



This device is sensitive to ElectroStatic Discharge (ESD). Therefore care should be taken during transport and handling.

1.2 Features and benefits

- Two low noise gain controlled amplifiers in a single package. One with a fully integrated bias and one with a partly integrated bias
- Internal switch to save external components
- Superior cross-modulation performance during AGC
- High forward transfer admittance
- High forward transfer admittance to input capacitance ratio

1.3 Applications

- Gain controlled low noise amplifiers for VHF and UHF applications with 5 V supply voltage
 - ◆ digital and analog television tuners
 - ◆ professional communication equipment



1.4 Quick reference data

Table 1. Quick reference data
Per MOSFET unless otherwise specified.

Symbol	Parameter	Conditions	Min	Typ	Max	Unit
V_{DS}	drain-source voltage (DC)		-	-	6	V
I_D	drain current (DC)		-	-	30	mA
P_{tot}	total power dissipation	$T_{sp} \leq 109\text{ }^\circ\text{C}$	[1]	-	180	mW
$ Y_{fs} $	forward transfer admittance	$f = 1\text{ MHz}$				
		amplifier A; $I_D = 19\text{ mA}$	26	31	41	mS
		amplifier B; $I_D = 13\text{ mA}$	28	33	43	mS
$C_{iss(G1)}$	input capacitance at gate1	$f = 1\text{ MHz}$				
		amplifier A	-	2.2	2.7	pF
		amplifier B	-	2.0	2.5	pF
C_{rss}	reverse transfer capacitance	$f = 1\text{ MHz}$	-	20	-	fF
NF	noise figure	amplifier A; $f = 400\text{ MHz}$	-	1.3	1.9	dB
		amplifier B; $f = 800\text{ MHz}$	-	1.4	2.1	dB
Xmod	cross-modulation	input level for $k = 1\%$ at 40 dB AGC				
		amplifier A	100	105	-	dB μ V
		amplifier B	100	103	-	dB μ V
T_j	junction temperature		-	-	150	$^\circ\text{C}$

[1] T_{sp} is the temperature at the soldering point of the source lead.

2. Pinning information

Table 2. Discrete pinning

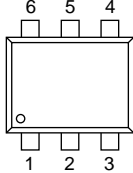
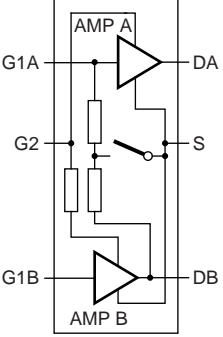
Pin	Description	Simplified outline	Symbol
1	gate1 (AMP A)		
2	gate2		
3	gate1 (AMP B)		
4	drain (AMP B)		
5	source		
6	drain (AMP A)		

3. Ordering information

Table 3. Ordering information

Type number	Package		
	Name	Description	Version
BF1208	-	plastic surface mounted package; 6 leads	SOT666

4. Marking

Table 4. Marking codes

Type number	Marking code
BF1208	2L

5. Limiting values

Table 5. Limiting values

In accordance with the Absolute Maximum Rating System (IEC 60134).

Symbol	Parameter	Conditions	Min	Max	Unit
Per MOSFET					
V_{DS}	drain-source voltage (DC)		-	6	V
I_D	drain current (DC)		-	30	mA
I_{G1}	gate1 current		-	±10	mA
I_{G2}	gate2 current		-	±10	mA
P_{tot}	total power dissipation	$T_{sp} \leq 109\text{ °C}$ [1]	-	180	mW
T_{stg}	storage temperature		-65	+150	°C
T_j	junction temperature		-	150	°C

[1] T_{sp} is the temperature at the soldering point of the source lead.

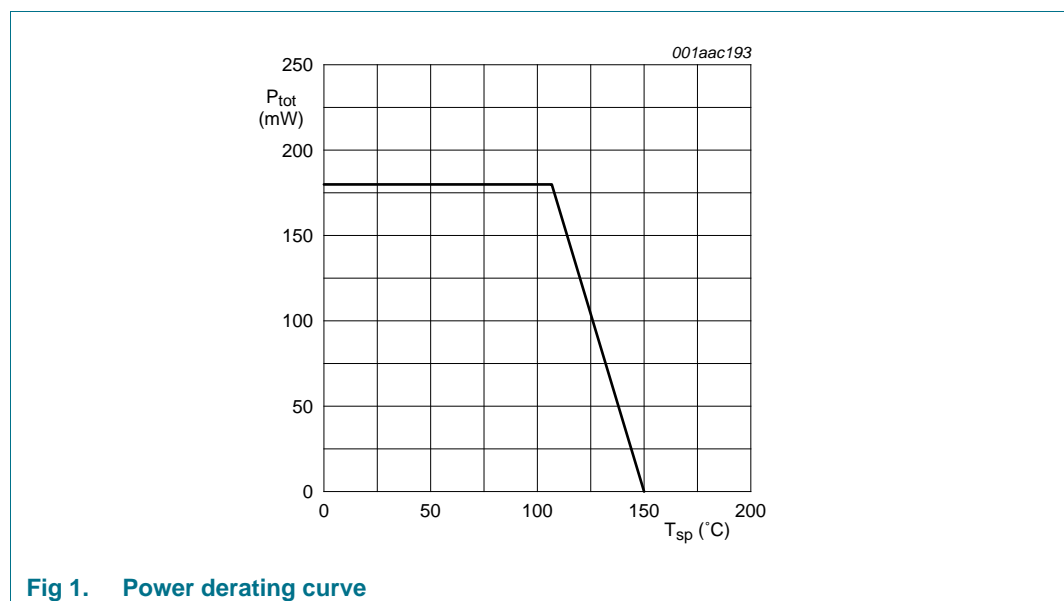

Fig 1. Power derating curve

6. Thermal characteristics

Table 6. Thermal characteristics

Symbol	Parameter	Conditions	Typ	Unit
$R_{th(j-sp)}$	thermal resistance from junction to solder point		225	K/W

7. Static characteristics

Table 7. Static characteristics

$T_j = 25\text{ }^\circ\text{C}$; unless otherwise specified.

Symbol	Parameter	Conditions	Min	Typ	Max	Unit	
Per MOSFET; unless otherwise specified							
$V_{(BR)DSS}$	drain-source breakdown voltage	$V_{G1-S} = V_{G2-S} = 0\text{ V}$; $I_D = 10\text{ }\mu\text{A}$					
		amplifier A	6	-	-	V	
		amplifier B	6	-	-	V	
$V_{(BR)G1-SS}$	gate1-source breakdown voltage	$V_{G2-S} = V_{DS} = 0\text{ V}$; $I_{G1-S} = 10\text{ mA}$	6	-	10	V	
$V_{(BR)G2-SS}$	gate2-source breakdown voltage	$V_{G1-S} = V_{DS} = 0\text{ V}$; $I_{G2-S} = 10\text{ mA}$	6	-	10	V	
$V_{F(S-G1)}$	forward source-gate1 voltage	$V_{G2-S} = V_{DS} = 0\text{ V}$; $I_{S-G1} = 10\text{ mA}$	0.5	-	1.5	V	
$V_{F(S-G2)}$	forward source-gate2 voltage	$V_{G1-S} = V_{DS} = 0\text{ V}$; $I_{S-G2} = 10\text{ mA}$	0.5	-	1.5	V	
$V_{G1-S(th)}$	gate1-source threshold voltage	$V_{DS} = 5\text{ V}$; $V_{G2-S} = 4\text{ V}$; $I_D = 100\text{ }\mu\text{A}$	0.3	-	1.0	V	
$V_{G2-S(th)}$	gate2-source threshold voltage	$V_{DS} = 5\text{ V}$; $V_{G1-S} = 5\text{ V}$; $I_D = 100\text{ }\mu\text{A}$	0.4	-	1.0	V	
I_{DSX}	drain-source current	$V_{G2-S} = 4\text{ V}$; $V_{DS(B)} = 5\text{ V}$; $R_{G1} = 150\text{ k}\Omega$					
		amplifier A; $V_{DS(A)} = 5\text{ V}$	[1]	14	-	24	mA
		amplifier B; $V_{DS(B)} = 5\text{ V}$	[2]	9	-	17	mA
I_{G1-S}	gate1 cut-off current	$V_{G2-S} = V_{DS(A)} = 0\text{ V}$					
		amplifier A; $V_{G1-S(A)} = 5\text{ V}$; $I_{D(B)} = 0\text{ A}$	-	-	50	nA	
		amplifier B; $V_{G1-S(B)} = 5\text{ V}$; $V_{DS(B)} = 0\text{ V}$	-	-	50	nA	
I_{G2-S}	gate2 cut-off current	$V_{G2-S} = 4\text{ V}$; $V_{G1-S(B)} = 0\text{ V}$; $V_{G1-S(A)} = V_{DS(A)} = V_{DS(B)} = 0\text{ V}$	-	-	20	nA	

[1] R_{G1} connects gate1 (B) to $V_{GG} = 0\text{ V}$ (see [Figure 3](#)).

[2] R_{G1} connects gate1 (B) to $V_{GG} = 5\text{ V}$ (see [Figure 3](#)).

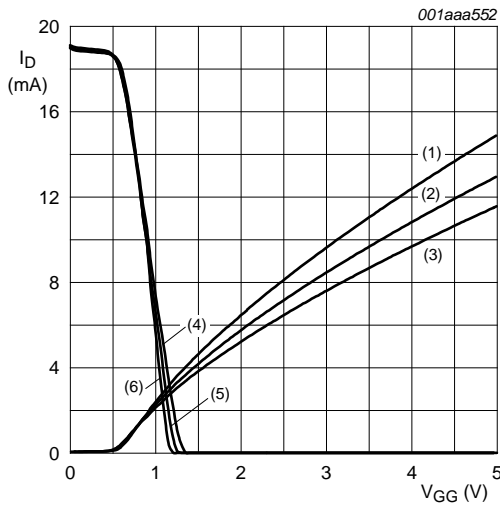

- (1) $I_{D(B)}$; $R_{G1} = 120 \text{ k}\Omega$.
- (2) $I_{D(B)}$; $R_{G1} = 150 \text{ k}\Omega$.
- (3) $I_{D(B)}$; $R_{G1} = 180 \text{ k}\Omega$.
- (4) $I_{D(A)}$; $R_{G1} = 180 \text{ k}\Omega$.
- (5) $I_{D(A)}$; $R_{G1} = 150 \text{ k}\Omega$.
- (6) $I_{D(A)}$; $R_{G1} = 120 \text{ k}\Omega$.

Fig 2. Drain currents of MOSFET A and B as a function of gate1 supply voltage

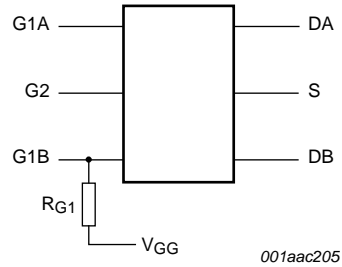

$V_{GG} = 5 \text{ V}$: amplifier A is off; amplifier B is on.
 $V_{GG} = 0 \text{ V}$: amplifier A is on; amplifier B is off.

Fig 3. Functional diagram

8. Dynamic characteristics

8.1 Dynamic characteristics for amplifier A

Table 8. Dynamic characteristics for amplifier A^[1]

Common source; $T_{amb} = 25 \text{ }^\circ\text{C}$; $V_{G2-S} = 4 \text{ V}$; $V_{DS} = 5 \text{ V}$; $I_D = 19 \text{ mA}$; unless otherwise specified.

Symbol	Parameter	Conditions	Min	Typ	Max	Unit
$ y_{fs} $	forward transfer admittance	$T_j = 25 \text{ }^\circ\text{C}$	26	31	41	mS
$C_{iss(G1)}$	input capacitance at gate1	$f = 1 \text{ MHz}$	-	2.2	2.7	pF
$C_{iss(G2)}$	input capacitance at gate2	$f = 1 \text{ MHz}$	-	3.0	-	pF
C_{oss}	output capacitance	$f = 1 \text{ MHz}$	-	0.9	-	pF
C_{rss}	reverse transfer capacitance	$f = 1 \text{ MHz}$	-	20	-	fF
G_{tr}	power gain	$B_S = B_{S(opt)}$; $B_L = B_{L(opt)}$				
		$f = 200 \text{ MHz}$; $G_S = 2 \text{ mS}$; $G_L = 0.5 \text{ mS}$	32	36	40	dB
		$f = 400 \text{ MHz}$; $G_S = 2 \text{ mS}$; $G_L = 1 \text{ mS}$	28	32	36	dB
		$f = 800 \text{ MHz}$; $G_S = 3.3 \text{ mS}$; $G_L = 1 \text{ mS}$	23	27	32	dB
NF	noise figure	$f = 11 \text{ MHz}$; $G_S = 20 \text{ mS}$; $B_S = 0 \text{ S}$	-	3.0	-	dB
		$f = 400 \text{ MHz}$; $Y_S = Y_{S(opt)}$	-	1.3	1.9	dB
		$f = 800 \text{ MHz}$; $Y_S = Y_{S(opt)}$	-	1.4	2.1	dB

Table 8. Dynamic characteristics for amplifier A^[1] ...continued

Common source; $T_{amb} = 25\text{ °C}$; $V_{G2-S} = 4\text{ V}$; $V_{DS} = 5\text{ V}$; $I_D = 19\text{ mA}$; unless otherwise specified.

Symbol	Parameter	Conditions	Min	Typ	Max	Unit
Xmod	cross-modulation	input level for $k = 1\%$; $f_w = 50\text{ MHz}$; $f_{unw} = 60\text{ MHz}$	[2]			
		at 0 dB AGC	90	-	-	dB μ V
		at 10 dB AGC	-	90	-	dB μ V
		at 20 dB AGC	-	99	-	dB μ V
		at 40 dB AGC	100	105	-	dB μ V

[1] For the MOSFET not in use: $V_{G1-S(B)} = 0\text{ V}$; $V_{DS(B)} = 0\text{ V}$.

[2] Measured in [Figure 33](#) test circuit.

8.1.1 Graphics for amplifier A

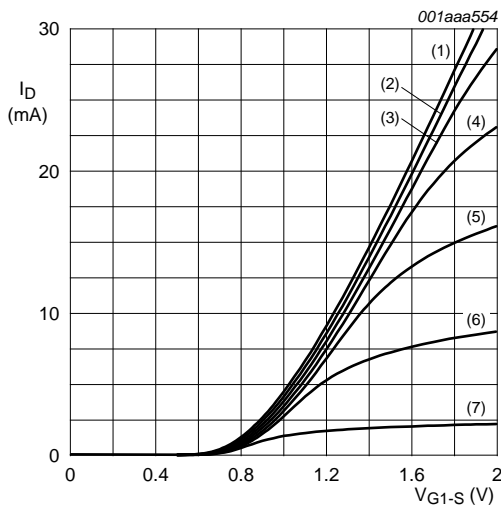

- (1) $V_{G2-S} = 4\text{ V}$.
 - (2) $V_{G2-S} = 3.5\text{ V}$.
 - (3) $V_{G2-S} = 3\text{ V}$.
 - (4) $V_{G2-S} = 2.5\text{ V}$.
 - (5) $V_{G2-S} = 2\text{ V}$.
 - (6) $V_{G2-S} = 1.5\text{ V}$.
 - (7) $V_{G2-S} = 1\text{ V}$.
- $V_{DS(A)} = 5\text{ V}$; $V_{G1-S(B)} = V_{DS(B)} = 0\text{ V}$; $T_j = 25\text{ °C}$.

Fig 4. Amplifier A: transfer characteristics; typical values

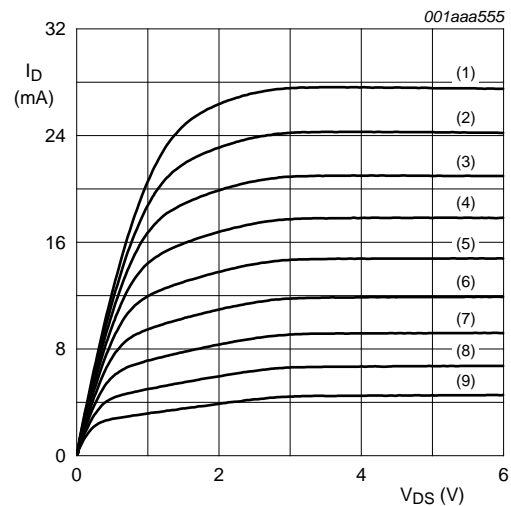

- (1) $V_{G1-S(A)} = 1.8\text{ V}$.
 - (2) $V_{G1-S(A)} = 1.7\text{ V}$.
 - (3) $V_{G1-S(A)} = 1.6\text{ V}$.
 - (4) $V_{G1-S(A)} = 1.5\text{ V}$.
 - (5) $V_{G1-S(A)} = 1.4\text{ V}$.
 - (6) $V_{G1-S(A)} = 1.3\text{ V}$.
 - (7) $V_{G1-S(A)} = 1.2\text{ V}$.
 - (8) $V_{G1-S(A)} = 1.1\text{ V}$.
 - (9) $V_{G1-S(A)} = 1\text{ V}$.
- $V_{G2-S} = 4\text{ V}$; $V_{G1-S(B)} = V_{DS(B)} = 0\text{ V}$; $T_j = 25\text{ °C}$.

Fig 5. Amplifier A: output characteristics; typical values

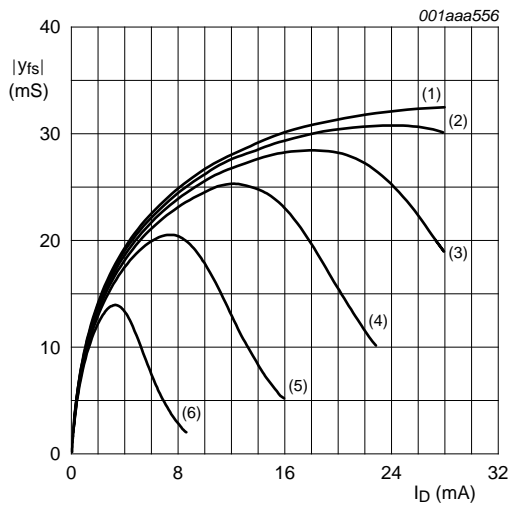

- (1) $V_{G2-S} = 4 \text{ V}$.
 - (2) $V_{G2-S} = 3.5 \text{ V}$.
 - (3) $V_{G2-S} = 3 \text{ V}$.
 - (4) $V_{G2-S} = 2.5 \text{ V}$.
 - (5) $V_{G2-S} = 2 \text{ V}$.
 - (6) $V_{G2-S} = 1.5 \text{ V}$.
- $V_{DS(A)} = 5 \text{ V}; V_{G1-S(B)} = V_{DS(B)} = 0 \text{ V}; T_j = 25 \text{ }^\circ\text{C}$.

Fig 6. Amplifier A: forward transfer admittance as a function of drain current; typical values

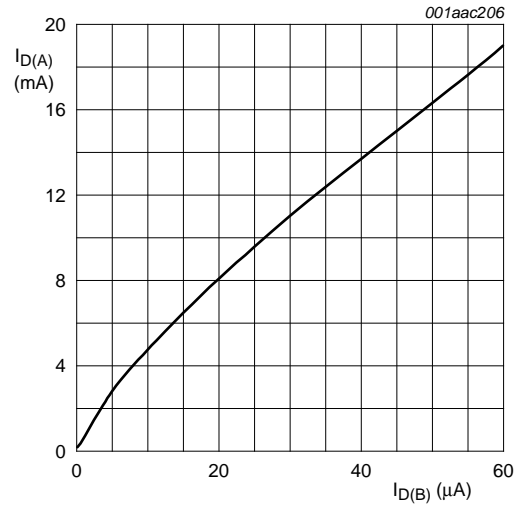

$V_{DS(A)} = 5 \text{ V}; V_{G2-S} = 4 \text{ V}; V_{DS(B)} = 5 \text{ V}; V_{G1-S(B)} = 0 \text{ V}; T_j = 25 \text{ }^\circ\text{C}$.

$I_{D(B)}$ = internal G1 current = current in pin drain (B) if MOSFET (B) is switched off.

Fig 7. Amplifier A: drain current as a function of internal G1 current; typical values

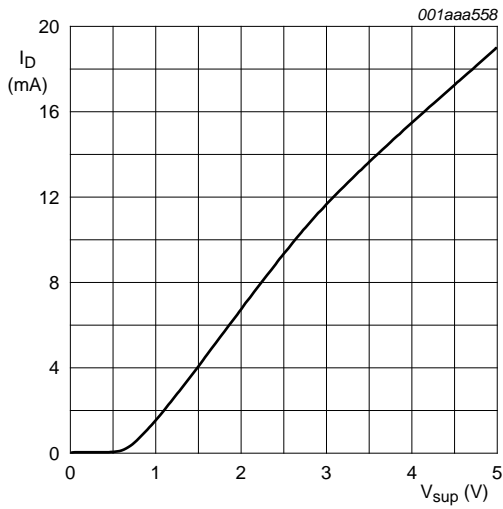

$V_{DS(A)} = V_{DS(B)} = V_{supply}$; $V_{G2-S} = 4\text{ V}$; $T_j = 25\text{ }^\circ\text{C}$;
 $R_{G1} = 150\text{ k}\Omega$ (connected to ground); see [Figure 3](#).

Fig 8. Amplifier A: drain current of amplifier A as a function of supply voltage of A and B amplifier; typical values

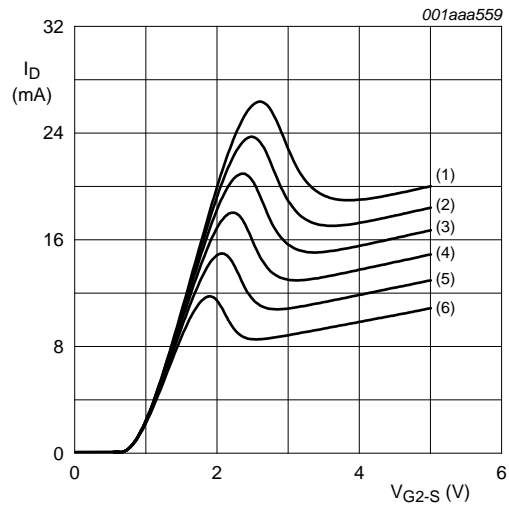

(1) $V_{DS(B)} = 5\text{ V}$.
 (2) $V_{DS(B)} = 4.5\text{ V}$.
 (3) $V_{DS(B)} = 4\text{ V}$.
 (4) $V_{DS(B)} = 3.5\text{ V}$.
 (5) $V_{DS(B)} = 3\text{ V}$.
 (6) $V_{DS(B)} = 2.5\text{ V}$.
 $V_{DS(A)} = 5\text{ V}$; $V_{G1-S(B)} = 0\text{ V}$; gate1 (A) = open;
 $T_j = 25\text{ }^\circ\text{C}$.

Fig 9. Amplifier A: drain current as a function of gate2 voltage; typical values

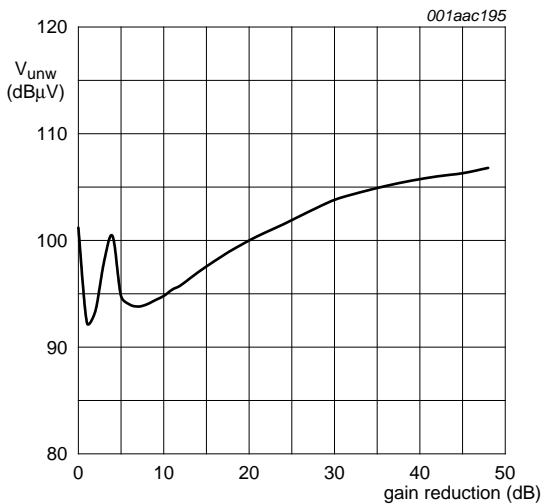

$V_{DS(A)} = V_{DS(B)} = 5\text{ V}$; $V_{G1-S(B)} = 0\text{ V}$; $f_w = 50\text{ MHz}$;
 $f_{unw} = 60\text{ MHz}$; $T_{amb} = 25\text{ }^\circ\text{C}$; see [Figure 33](#).

Fig 10. Amplifier A: unwanted voltage for 1 % cross-modulation as a function of gain reduction; typical values

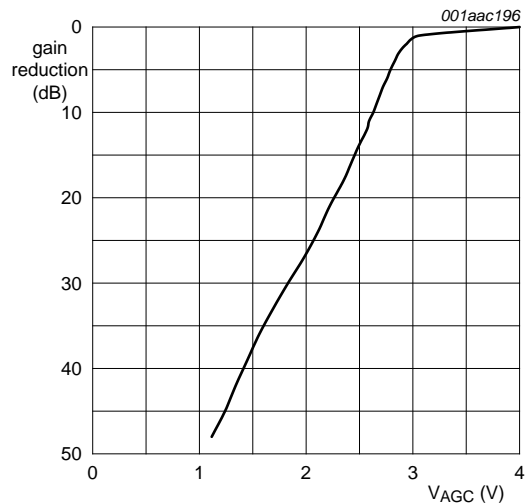

$V_{DS(A)} = V_{DS(B)} = 5\text{ V}$; $V_{G1-S(B)} = 0\text{ V}$; $f = 50\text{ MHz}$; see [Figure 33](#).

Fig 11. Amplifier A: gain reduction as a function of AGC voltage; typical values

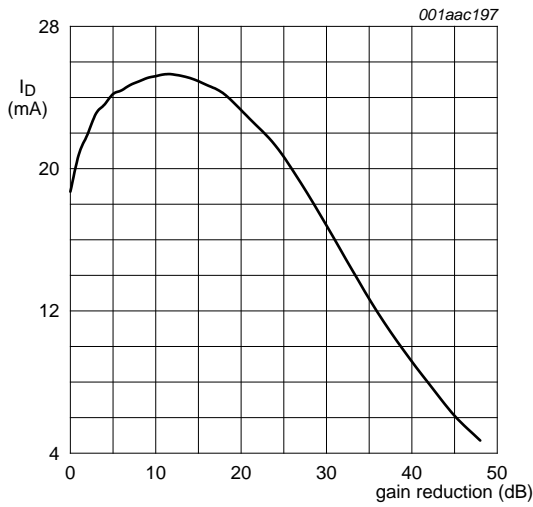

$V_{DS(A)} = V_{DS(B)} = 5\text{ V}$; $V_{G1-S(B)} = 0\text{ V}$; $f = 50\text{ MHz}$;
 $T_{amb} = 25\text{ }^{\circ}\text{C}$; see [Figure 33](#).

Fig 12. Amplifier A: drain current as a function of gain reduction; typical values

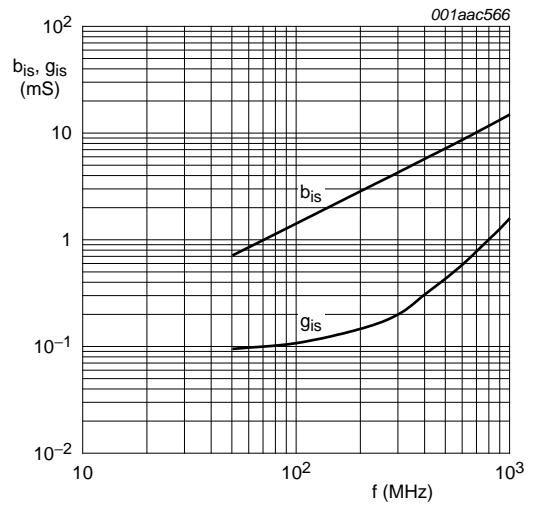

$V_{DS(A)} = 5\text{ V}$; $V_{G2-S} = 4\text{ V}$; $V_{DS(B)} = V_{G1-S(B)} = 0\text{ V}$;
 $I_{D(A)} = 19\text{ mA}$

Fig 13. Amplifier A: input admittance as a function of frequency; typical values

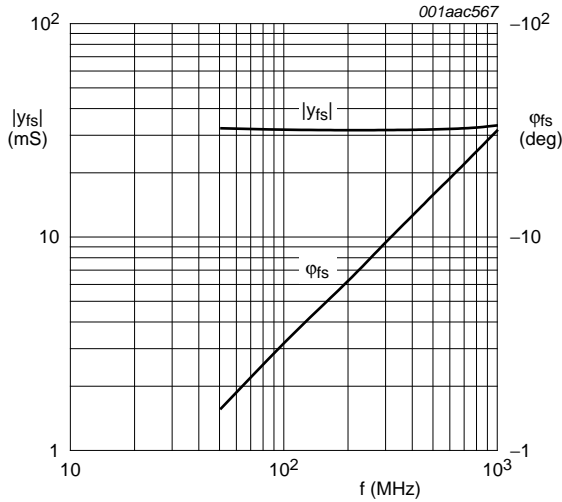

$V_{DS(A)} = 5\text{ V}$; $V_{G2-S} = 4\text{ V}$; $V_{DS(B)} = V_{G1-S(B)} = 0\text{ V}$;
 $I_{D(A)} = 19\text{ mA}$

Fig 14. Amplifier A: forward transfer admittance and phase as a function of frequency; typical values

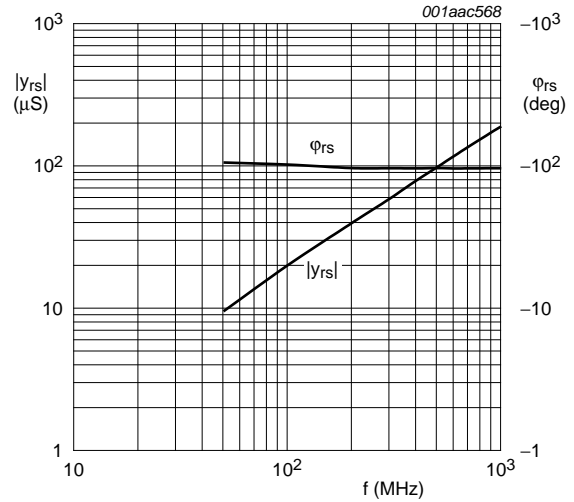

$V_{DS(A)} = 5\text{ V}$; $V_{G2-S} = 4\text{ V}$; $V_{DS(B)} = V_{G1-S(B)} = 0\text{ V}$;
 $I_{D(A)} = 19\text{ mA}$

Fig 15. Amplifier A: reverse transfer admittance and phase as a function of frequency; typical values

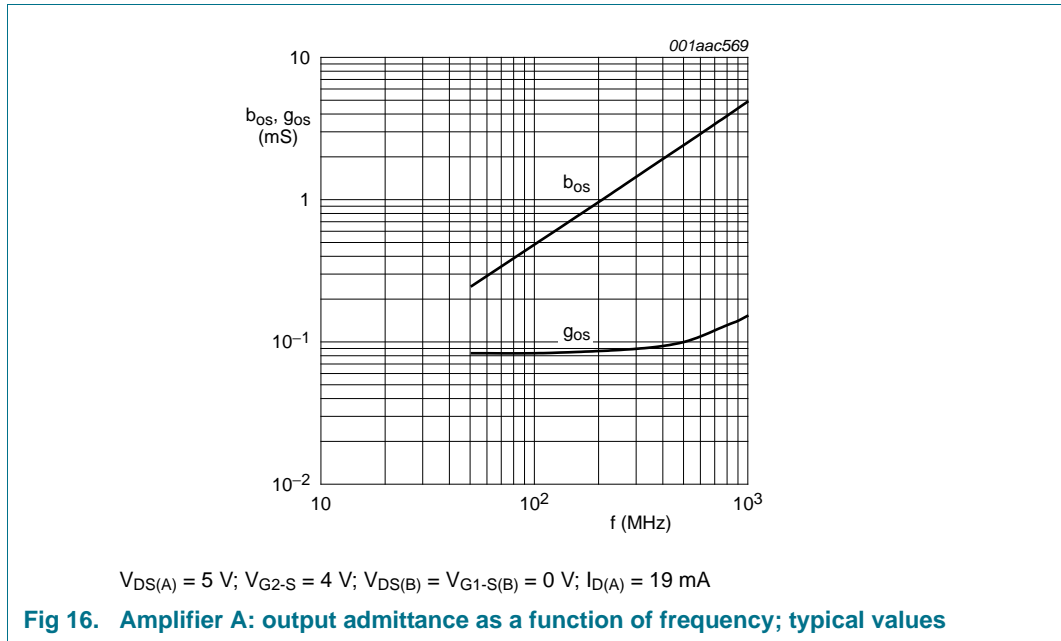

8.1.2 Scattering parameters for amplifier A

Table 9. Scattering parameters for amplifier A

$V_{DS(A)} = 5\text{ V}; V_{G2-S} = 4\text{ V}; I_{D(A)} = 19\text{ mA}; V_{DS(B)} = 0\text{ V}; V_{G1-S(B)} = 0\text{ V}; T_{amb} = 25\text{ }^\circ\text{C};$ typical values.

f (MHz)	S ₁₁		S ₂₁		S ₁₂		S ₂₂	
	Magnitude (ratio)	Angle (deg)	Magnitude (ratio)	Angle (deg)	Magnitude (ratio)	Angle (deg)	Magnitude (ratio)	Angle (deg)
50	0.991	-3.86	3.08	175.91	0.0009	77.41	0.992	-1.41
100	0.990	-7.73	3.03	171.76	0.0019	78.10	0.991	-2.81
200	0.986	-15.43	2.99	163.68	0.0037	78.39	0.990	-5.57
300	0.980	-22.98	2.94	155.54	0.0054	73.53	0.989	-8.34
400	0.970	-30.44	2.89	147.55	0.0070	68.74	0.986	-11.08
500	0.960	-37.60	2.82	139.76	0.0085	63.64	0.983	-13.78
600	0.948	-44.62	2.75	132.16	0.0098	59.62	0.980	-16.45
700	0.935	-51.44	2.67	124.70	0.0110	55.09	0.977	-19.10
800	0.921	-58.04	2.58	117.39	0.0120	50.79	0.973	-21.69
900	0.908	-64.41	2.50	110.20	0.0128	46.62	0.970	-24.28
1000	0.894	-70.49	2.40	103.31	0.0135	42.78	0.967	-26.87

8.1.3 Noise data for amplifier A

Table 10. Noise data for amplifier A

$V_{DS(A)} = 5\text{ V}; V_{G2-S} = 4\text{ V}; I_{D(A)} = 19\text{ mA}; V_{DS(B)} = 0\text{ V}; V_{G1-S(B)} = 0\text{ V}; T_{amb} = 25\text{ }^\circ\text{C};$ typical values; unless otherwise specified.

f (MHz)	NF _{min} (dB)	Γ _{opt}		r _n (Ω)
		ratio	(deg)	
400	1.3	0.718	16.06	0.683
800	1.4	0.677	37.59	0.681

8.2 Dynamic characteristics for amplifier B

Table 11. Dynamic characteristics for amplifier B^[1]

Common source; $T_{amb} = 25\text{ °C}$; $V_{G2-S} = 4\text{ V}$; $V_{DS} = 5\text{ V}$; $I_D = 13\text{ mA}$; unless otherwise specified.

Symbol	Parameter	Conditions	Min	Typ	Max	Unit
$ y_{fs} $	forward transfer admittance	$T_j = 25\text{ °C}$	28	33	43	mS
$C_{iss(G1)}$	input capacitance at gate1	$f = 1\text{ MHz}$	-	2.0	2.5	pF
$C_{iss(G2)}$	input capacitance at gate2	$f = 1\text{ MHz}$	-	3.4	-	pF
C_{oss}	output capacitance	$f = 1\text{ MHz}$	-	0.85	-	pF
C_{rss}	reverse transfer capacitance	$f = 1\text{ MHz}$	-	20	-	fF
G_{tr}	power gain	$B_S = B_{S(opt)}$; $B_L = B_{L(opt)}$				
		$f = 200\text{ MHz}$; $G_S = 2\text{ mS}$; $G_L = 0.5\text{ mS}$	33	37	41	dB
		$f = 400\text{ MHz}$; $G_S = 2\text{ mS}$; $G_L = 1\text{ mS}$	30	34	38	dB
		$f = 800\text{ MHz}$; $G_S = 3.3\text{ mS}$; $G_L = 1\text{ mS}$	29	33	37	dB
NF	noise figure	$f = 11\text{ MHz}$; $G_S = 20\text{ mS}$; $B_S = 0\text{ S}$	-	5	-	dB
		$f = 400\text{ MHz}$; $Y_S = Y_{S(opt)}$	-	1.3	1.9	dB
		$f = 800\text{ MHz}$; $Y_S = Y_{S(opt)}$	-	1.4	2.1	dB
Xmod	cross-modulation	input level for $k = 1\%$; $f_w = 50\text{ MHz}$; $f_{unw} = 60\text{ MHz}$	[2]			
		at 0 dB AGC	90	-	-	dB μ V
		at 10 dB AGC	-	88	-	dB μ V
		at 20 dB AGC	-	94	-	dB μ V
		at 40 dB AGC	100	103	-	dB μ V

[1] For the MOSFET not in use: $V_{G1-S(A)} = 0\text{ V}$; $V_{DS(A)} = 0\text{ V}$.

[2] Measured in [Figure 34](#) test circuit.

8.2.1 Graphics for amplifier B

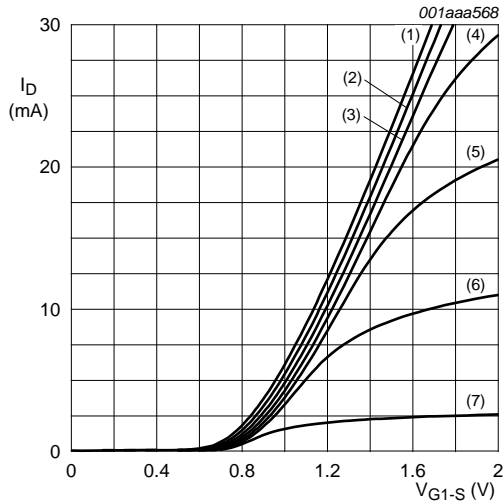

- (1) $V_{G2-S} = 4 \text{ V}$.
 - (2) $V_{G2-S} = 3.5 \text{ V}$.
 - (3) $V_{G2-S} = 3 \text{ V}$.
 - (4) $V_{G2-S} = 2.5 \text{ V}$.
 - (5) $V_{G2-S} = 2 \text{ V}$.
 - (6) $V_{G2-S} = 1.5 \text{ V}$.
 - (7) $V_{G2-S} = 1 \text{ V}$.
- $V_{DS(B)} = 5 \text{ V}$; $V_{DS(A)} = V_{G1-S(A)} = 0 \text{ V}$; $T_j = 25 \text{ }^\circ\text{C}$.

Fig 17. Amplifier B: transfer characteristics; typical values

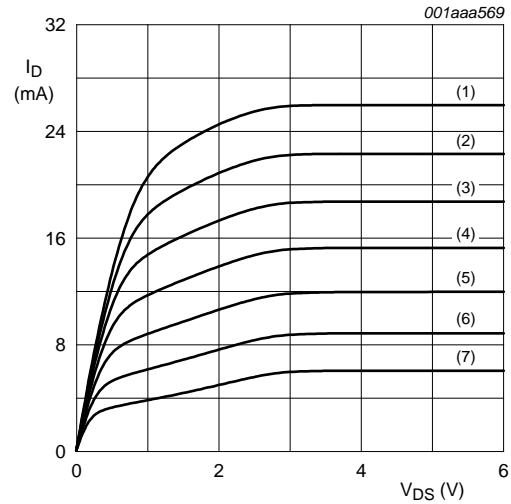

- (1) $V_{G1-S(B)} = 1.6 \text{ V}$.
 - (2) $V_{G1-S(B)} = 1.5 \text{ V}$.
 - (3) $V_{G1-S(B)} = 1.4 \text{ V}$.
 - (4) $V_{G1-S(B)} = 1.3 \text{ V}$.
 - (5) $V_{G1-S(B)} = 1.2 \text{ V}$.
 - (6) $V_{G1-S(B)} = 1.1 \text{ V}$.
 - (7) $V_{G1-S(B)} = 1 \text{ V}$.
- $V_{G2-S} = 4 \text{ V}$; $V_{DS(A)} = V_{G1-S(A)} = 0 \text{ V}$; $T_j = 25 \text{ }^\circ\text{C}$.

Fig 18. Amplifier B: output characteristics; typical values

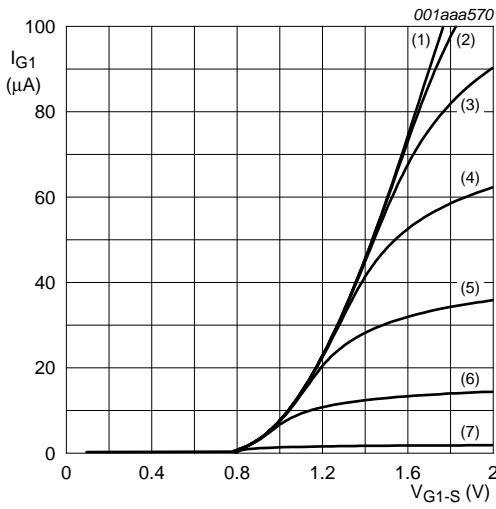

(1) $V_{G2-S} = 4\text{ V}$.
 (2) $V_{G2-S} = 3.5\text{ V}$.
 (3) $V_{G2-S} = 3\text{ V}$.
 (4) $V_{G2-S} = 2.5\text{ V}$.
 (5) $V_{G2-S} = 2\text{ V}$.
 (6) $V_{G2-S} = 1.5\text{ V}$.
 (7) $V_{G2-S} = 1\text{ V}$.
 $V_{DS(B)} = 5\text{ V}$; $V_{DS(A)} = V_{G1-S(A)} = 0\text{ V}$; $T_j = 25\text{ }^\circ\text{C}$.

Fig 19. Amplifier B: gate1 current as a function of gate1 voltage; typical values

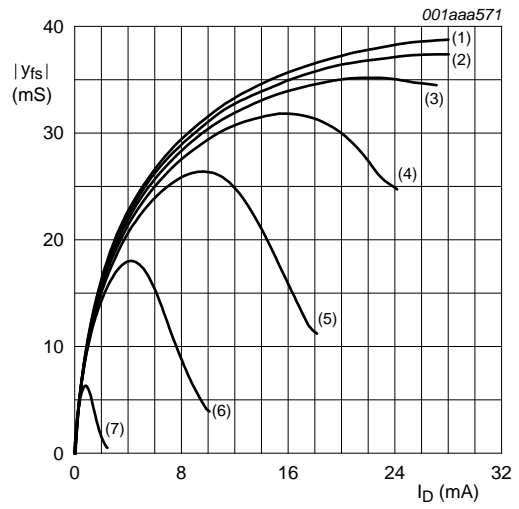

(1) $V_{G2-S} = 4\text{ V}$.
 (2) $V_{G2-S} = 3.5\text{ V}$.
 (3) $V_{G2-S} = 3\text{ V}$.
 (4) $V_{G2-S} = 2.5\text{ V}$.
 (5) $V_{G2-S} = 2\text{ V}$.
 (6) $V_{G2-S} = 1.5\text{ V}$.
 (7) $V_{G2-S} = 1\text{ V}$.
 $V_{DS(B)} = 5\text{ V}$; $V_{DS(A)} = V_{G1-S(A)} = 0\text{ V}$; $T_j = 25\text{ }^\circ\text{C}$.

Fig 20. Amplifier B: forward transfer admittance as a function of drain current; typical values

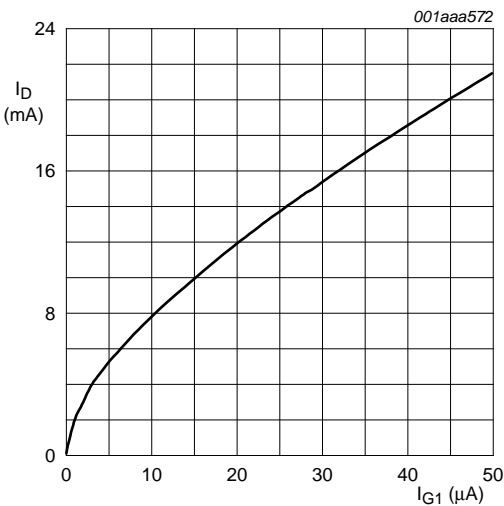

$V_{DS(B)} = 5\text{ V}$; $V_{G2-S} = 4\text{ V}$; $V_{DS(A)} = V_{G1-S(A)} = 0\text{ V}$;
 $T_j = 25\text{ }^\circ\text{C}$.

Fig 21. Amplifier B: drain current as a function of gate1 current; typical values

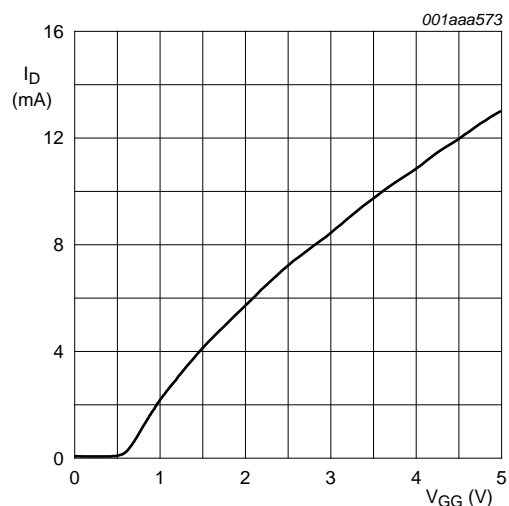

$V_{DS(B)} = 5\text{ V}$; $V_{G2-S} = 4\text{ V}$; $V_{DS(A)} = V_{G1-S(A)} = 0\text{ V}$;
 $T_j = 25\text{ }^\circ\text{C}$; $R_{G1} = 150\text{ k}\Omega$ (connected to V_{GG}); see [Figure 3](#).

Fig 22. Amplifier B: drain current as a function of gate1 supply voltage; typical values

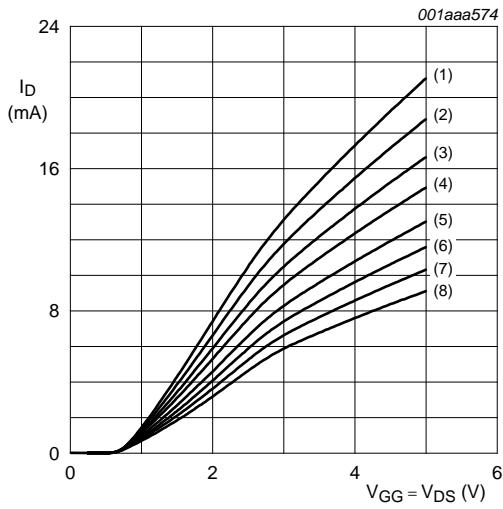

- (1) $R_{G1} = 68 \text{ k}\Omega$.
- (2) $R_{G1} = 82 \text{ k}\Omega$.
- (3) $R_{G1} = 100 \text{ k}\Omega$.
- (4) $R_{G1} = 120 \text{ k}\Omega$.
- (5) $R_{G1} = 150 \text{ k}\Omega$.
- (6) $R_{G1} = 180 \text{ k}\Omega$.
- (7) $R_{G1} = 220 \text{ k}\Omega$.
- (8) $R_{G1} = 270 \text{ k}\Omega$.

$V_{G2-S} = 4 \text{ V}$; $V_{DS(A)} = V_{G1-S(A)} = 0 \text{ V}$; $T_j = 25 \text{ }^\circ\text{C}$; R_{G1} is connected to V_{GG} ; see [Figure 3](#).

Fig 23. Amplifier B: drain current as a function of gate1 supply voltage and drain supply voltage; typical values

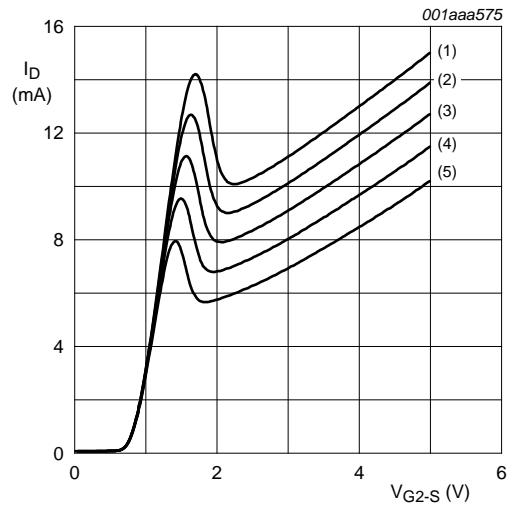

- (1) $V_{GG} = 5.0 \text{ V}$.
- (2) $V_{GG} = 4.5 \text{ V}$.
- (3) $V_{GG} = 4.0 \text{ V}$.
- (4) $V_{GG} = 3.5 \text{ V}$.
- (5) $V_{GG} = 3.0 \text{ V}$.

$V_{DS(B)} = 5 \text{ V}$; $V_{DS(A)} = V_{G1-S(A)} = 0 \text{ V}$; $T_j = 25 \text{ }^\circ\text{C}$; $R_{G1} = 150 \text{ k}\Omega$ (connected to V_{GG}); see [Figure 3](#).

Fig 24. Amplifier B: drain current as a function of gate2 voltage; typical values

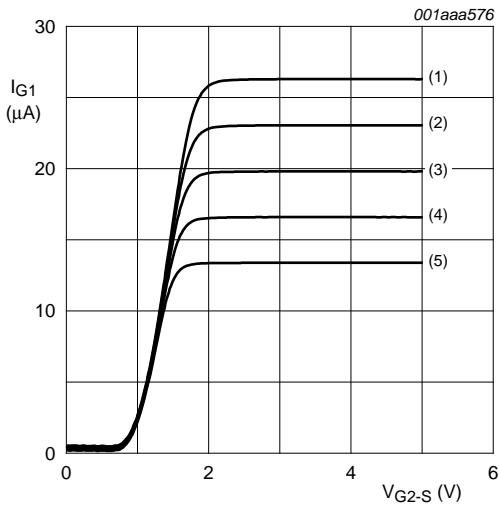

(1) $V_{GG} = 5.0 \text{ V}$.
 (2) $V_{GG} = 4.5 \text{ V}$.
 (3) $V_{GG} = 4.0 \text{ V}$.
 (4) $V_{GG} = 3.5 \text{ V}$.
 (5) $V_{GG} = 3.0 \text{ V}$.
 $V_{DS(B)} = 5 \text{ V}$; $V_{DS(A)} = V_{G1-S(A)} = 0 \text{ V}$; $T_j = 25 \text{ }^\circ\text{C}$;
 $R_{G1} = 150 \text{ k}\Omega$ (connected to V_{GG}); see [Figure 3](#).

Fig 25. Amplifier B: gate1 current as a function of gate2 voltage; typical values

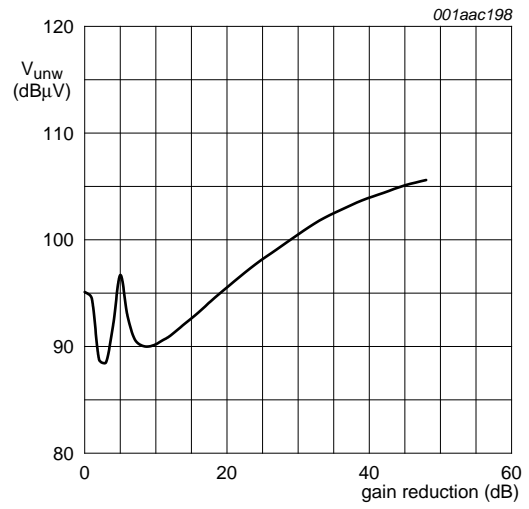

$V_{DS(B)} = 5 \text{ V}$; $V_{GG} = 5 \text{ V}$; $V_{DS(A)} = V_{G1-S(A)} = 0 \text{ V}$;
 $R_{G1} = 150 \text{ k}\Omega$ (connected to V_{GG}); $f_w = 50 \text{ MHz}$;
 $f_{unw} = 60 \text{ MHz}$; $T_{amb} = 25 \text{ }^\circ\text{C}$; see [Figure 34](#).

Fig 26. Amplifier B: unwanted voltage for 1 % cross-modulation as a function of gain reduction; typical values

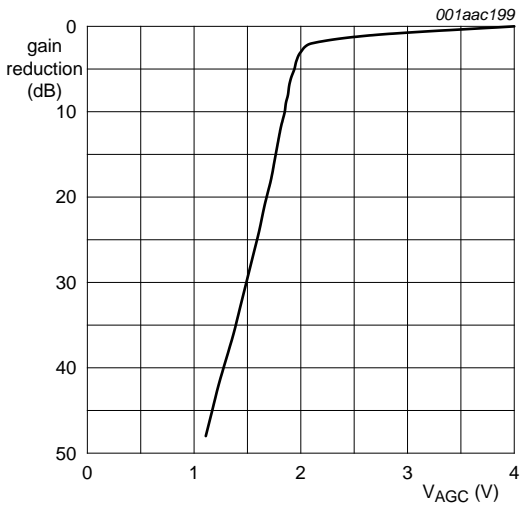

$V_{DS(B)} = 5 \text{ V}$; $V_{GG} = 5 \text{ V}$; $V_{DS(A)} = V_{G1-S(A)} = 0 \text{ V}$;
 $R_{G1} = 150 \text{ k}\Omega$ (connected to V_{GG}); $f = 50 \text{ MHz}$;
 $T_{amb} = 25 \text{ }^\circ\text{C}$; see [Figure 34](#).

Fig 27. Amplifier B: gain reduction as a function of AGC voltage; typical values

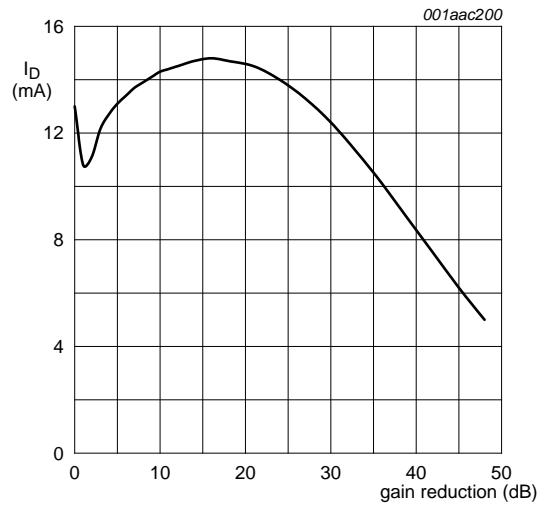

$V_{DS(B)} = 5 \text{ V}$; $V_{GG} = 5 \text{ V}$; $V_{DS(A)} = V_{G1-S(A)} = 0 \text{ V}$;
 $R_{G1} = 150 \text{ k}\Omega$ (connected to V_{GG}); $f = 50 \text{ MHz}$;
 $T_{amb} = 25 \text{ }^\circ\text{C}$; see [Figure 34](#).

Fig 28. Amplifier B: drain current as a function of gain reduction; typical values

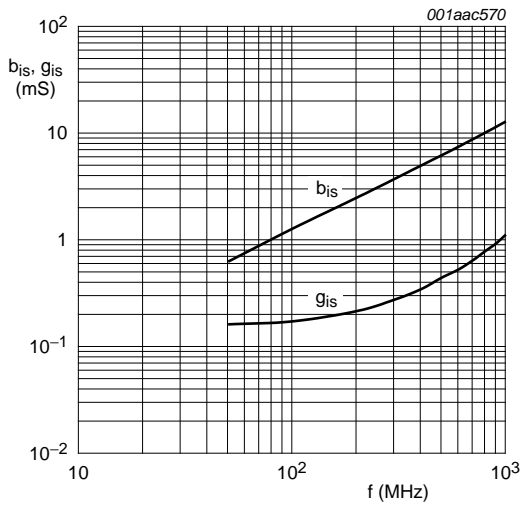

$V_{DS(B)} = 5\text{ V}; V_{G2-S} = 4\text{ V}; V_{DS(A)} = V_{G1-S(A)} = 0\text{ V}; I_{D(B)} = 13\text{ mA}$

Fig 29. Amplifier B: input admittance as a function of frequency; typical values

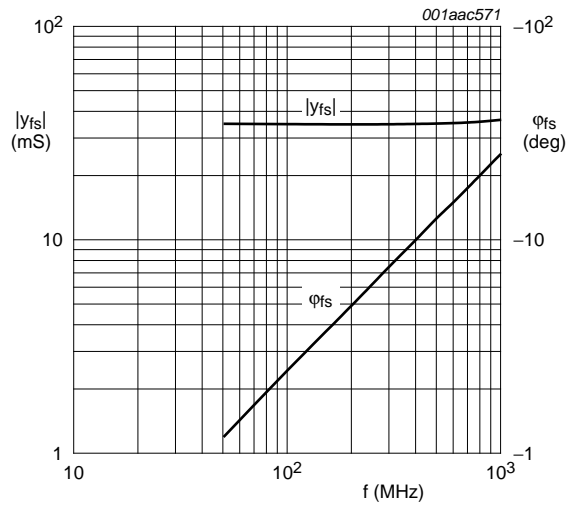

$V_{DS(B)} = 5\text{ V}; V_{G2-S} = 4\text{ V}; V_{DS(A)} = V_{G1-S(A)} = 0\text{ V}; I_{D(B)} = 13\text{ mA}$

Fig 30. Amplifier B: forward transfer admittance and phase as a function of frequency; typical values

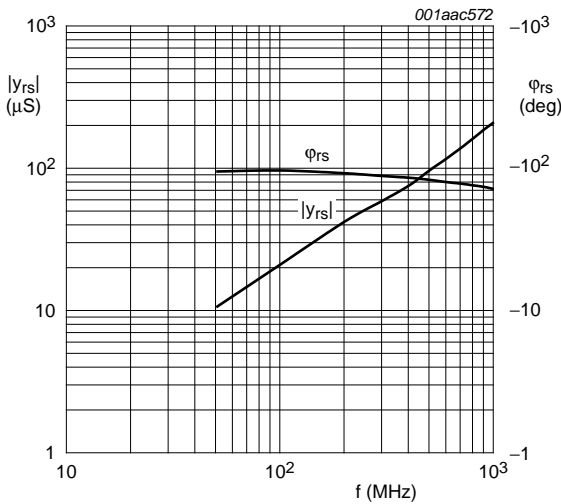

$V_{DS(B)} = 5\text{ V}; V_{G2-S} = 4\text{ V}; V_{DS(A)} = V_{G1-S(A)} = 0\text{ V}; I_{D(B)} = 13\text{ mA}$

Fig 31. Amplifier B: reverse transfer admittance and phase as a function of frequency; typical values

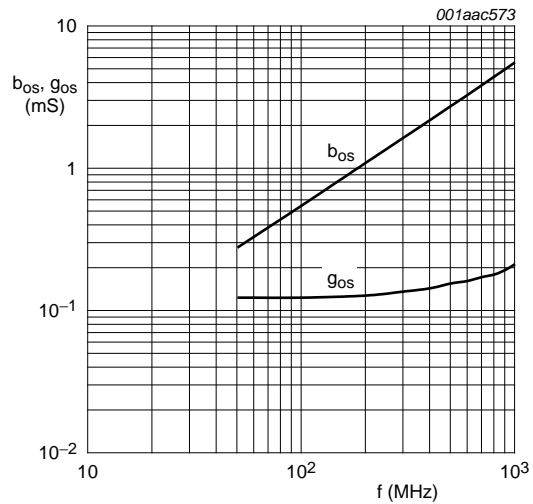

$V_{DS(B)} = 5\text{ V}; V_{G2-S} = 4\text{ V}; V_{DS(A)} = V_{G1-S(A)} = 0\text{ V}; I_{D(B)} = 13\text{ mA}$

Fig 32. Amplifier B: output admittance as a function of frequency; typical values

8.2.2 Scattering parameters for amplifier B

Table 12. Scattering parameters for amplifier B

$V_{DS(B)} = 5\text{ V}$; $V_{G2-S} = 4\text{ V}$; $I_{D(B)} = 13\text{ mA}$; $V_{DS(A)} = 0\text{ V}$; $V_{G1-S(A)} = 0\text{ V}$; $T_{amb} = 25\text{ °C}$; typical values.

f (MHz)	S ₁₁		S ₂₁		S ₁₂		S ₂₂	
	Magnitude (ratio)	Angle (deg)	Magnitude (ratio)	Angle (deg)	Magnitude (ratio)	Angle (deg)	Magnitude (ratio)	Angle (deg)
50	0.985	-3.42	3.33	176.41	0.0010	87.55	0.988	-1.60
100	0.984	-6.96	3.31	172.70	0.0020	83.45	0.988	-3.16
200	0.980	-13.51	3.27	165.59	0.0039	82.84	0.987	-6.31
300	0.975	-20.07	3.23	158.42	0.0054	82.01	0.986	-9.40
400	0.969	-26.61	3.19	151.34	0.0068	79.73	0.984	-12.46
500	0.961	-32.89	3.14	144.33	0.0085	77.91	0.982	-15.57
600	0.955	-39.19	3.07	137.54	0.0100	76.31	0.980	-18.62
700	0.945	-45.39	3.00	130.72	0.0115	73.76	0.977	-21.70
800	0.938	-51.39	2.93	123.98	0.0131	71.58	0.974	-24.76
900	0.930	-57.36	2.85	117.31	0.0145	69.18	0.971	-27.81
1000	0.920	-63.10	2.77	110.39	0.0157	67.54	0.967	-30.86

8.2.3 Noise data for amplifier B

Table 13. Noise data for amplifier B

$V_{DS(B)} = 5\text{ V}$; $V_{G2-S} = 4\text{ V}$; $I_{D(B)} = 13\text{ mA}$; $V_{DS(A)} = 0\text{ V}$; $V_{G1-S(A)} = 0\text{ V}$; $T_{amb} = 25\text{ °C}$; typical values; unless otherwise specified.

f (MHz)	NF _{min} (dB)	Γ _{opt}		r _n (Ω)
		ratio	(deg)	
400	1.3	0.695	13.11	0.694
800	1.4	0.674	32.77	0.674

9. Test information

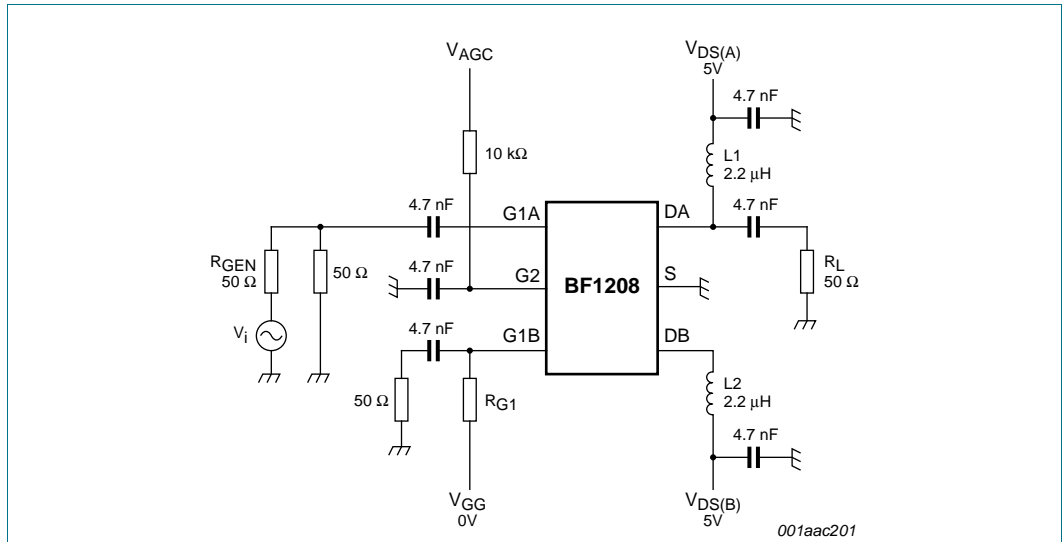

Fig 33. Cross-modulation test set-up for amplifier A

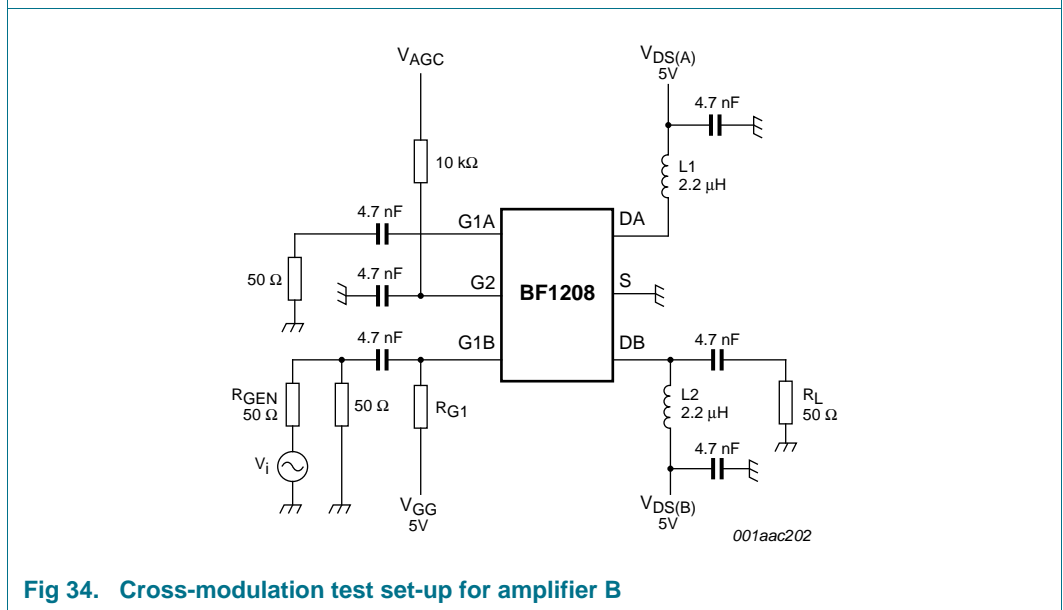

Fig 34. Cross-modulation test set-up for amplifier B

10. Package outline

Plastic surface-mounted package; 6 leads

SOT666

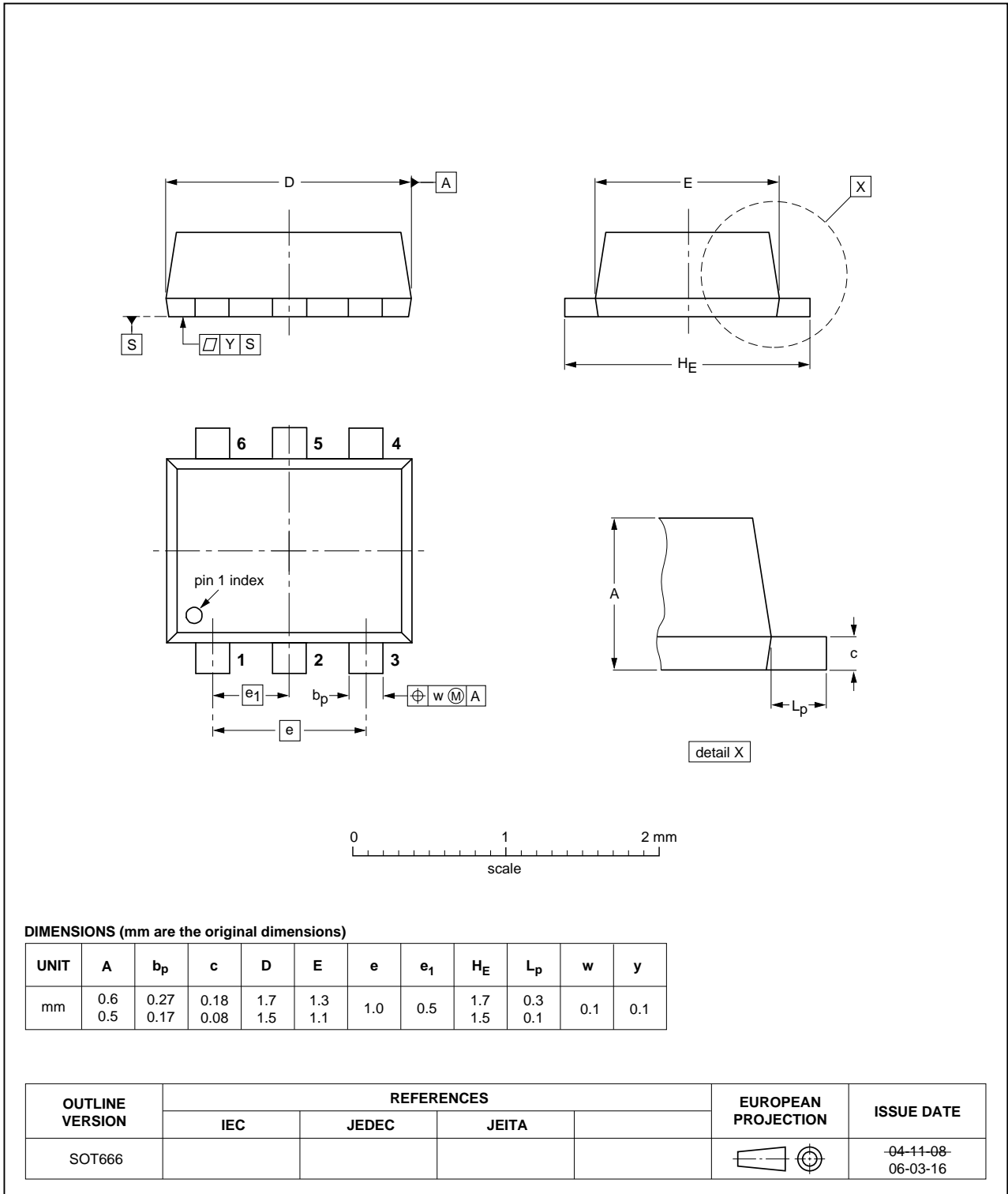

Fig 35. Package outline SOT666

11. Revision history

Table 14. Revision history

Document ID	Release date	Data sheet status	Change notice	Supersedes
BF1208 v.2	20110907	Product data sheet	-	BF1208 v.1
Modifications:		<ul style="list-style-type: none">• The format of this data sheet has been redesigned to comply with the new identity guidelines of NXP Semiconductors.• Legal texts have been adapted to the new company name where appropriate.• Package outline drawings have been updated to the latest version.		
BF1208 v.1 (9397 750 14254)	20050316	Product data sheet	-	-

12. Legal information

12.1 Data sheet status

Document status ^{[1][2]}	Product status ^[3]	Definition
Objective [short] data sheet	Development	This document contains data from the objective specification for product development.
Preliminary [short] data sheet	Qualification	This document contains data from the preliminary specification.
Product [short] data sheet	Production	This document contains the product specification.

[1] Please consult the most recently issued document before initiating or completing a design.

[2] The term 'short data sheet' is explained in section "Definitions".

[3] The product status of device(s) described in this document may have changed since this document was published and may differ in case of multiple devices. The latest product status information is available on the Internet at URL <http://www.nxp.com>.

12.2 Definitions

Draft — The document is a draft version only. The content is still under internal review and subject to formal approval, which may result in modifications or additions. NXP Semiconductors does not give any representations or warranties as to the accuracy or completeness of information included herein and shall have no liability for the consequences of use of such information.

Short data sheet — A short data sheet is an extract from a full data sheet with the same product type number(s) and title. A short data sheet is intended for quick reference only and should not be relied upon to contain detailed and full information. For detailed and full information see the relevant full data sheet, which is available on request via the local NXP Semiconductors sales office. In case of any inconsistency or conflict with the short data sheet, the full data sheet shall prevail.

Product specification — The information and data provided in a Product data sheet shall define the specification of the product as agreed between NXP Semiconductors and its customer, unless NXP Semiconductors and customer have explicitly agreed otherwise in writing. In no event however, shall an agreement be valid in which the NXP Semiconductors product is deemed to offer functions and qualities beyond those described in the Product data sheet.

12.3 Disclaimers

Limited warranty and liability — Information in this document is believed to be accurate and reliable. However, NXP Semiconductors does not give any representations or warranties, expressed or implied, as to the accuracy or completeness of such information and shall have no liability for the consequences of use of such information.

In no event shall NXP Semiconductors be liable for any indirect, incidental, punitive, special or consequential damages (including - without limitation - lost profits, lost savings, business interruption, costs related to the removal or replacement of any products or rework charges) whether or not such damages are based on tort (including negligence), warranty, breach of contract or any other legal theory.

Notwithstanding any damages that customer might incur for any reason whatsoever, NXP Semiconductors' aggregate and cumulative liability towards customer for the products described herein shall be limited in accordance with the *Terms and conditions of commercial sale* of NXP Semiconductors.

Right to make changes — NXP Semiconductors reserves the right to make changes to information published in this document, including without limitation specifications and product descriptions, at any time and without notice. This document supersedes and replaces all information supplied prior to the publication hereof.

Suitability for use — NXP Semiconductors products are not designed, authorized or warranted to be suitable for use in life support, life-critical or safety-critical systems or equipment, nor in applications where failure or

malfunction of an NXP Semiconductors product can reasonably be expected to result in personal injury, death or severe property or environmental damage. NXP Semiconductors accepts no liability for inclusion and/or use of NXP Semiconductors products in such equipment or applications and therefore such inclusion and/or use is at the customer's own risk.

Applications — Applications that are described herein for any of these products are for illustrative purposes only. NXP Semiconductors makes no representation or warranty that such applications will be suitable for the specified use without further testing or modification.

Customers are responsible for the design and operation of their applications and products using NXP Semiconductors products, and NXP Semiconductors accepts no liability for any assistance with applications or customer product design. It is customer's sole responsibility to determine whether the NXP Semiconductors product is suitable and fit for the customer's applications and products planned, as well as for the planned application and use of customer's third party customer(s). Customers should provide appropriate design and operating safeguards to minimize the risks associated with their applications and products.

NXP Semiconductors does not accept any liability related to any default, damage, costs or problem which is based on any weakness or default in the customer's applications or products, or the application or use by customer's third party customer(s). Customer is responsible for doing all necessary testing for the customer's applications and products using NXP Semiconductors products in order to avoid a default of the applications and the products or of the application or use by customer's third party customer(s). NXP does not accept any liability in this respect.

Limiting values — Stress above one or more limiting values (as defined in the Absolute Maximum Ratings System of IEC 60134) will cause permanent damage to the device. Limiting values are stress ratings only and (proper) operation of the device at these or any other conditions above those given in the Recommended operating conditions section (if present) or the Characteristics sections of this document is not warranted. Constant or repeated exposure to limiting values will permanently and irreversibly affect the quality and reliability of the device.

Terms and conditions of commercial sale — NXP Semiconductors products are sold subject to the general terms and conditions of commercial sale, as published at <http://www.nxp.com/profile/terms>, unless otherwise agreed in a valid written individual agreement. In case an individual agreement is concluded only the terms and conditions of the respective agreement shall apply. NXP Semiconductors hereby expressly objects to applying the customer's general terms and conditions with regard to the purchase of NXP Semiconductors products by customer.

No offer to sell or license — Nothing in this document may be interpreted or construed as an offer to sell products that is open for acceptance or the grant, conveyance or implication of any license under any copyrights, patents or other industrial or intellectual property rights.

Export control — This document as well as the item(s) described herein may be subject to export control regulations. Export might require a prior authorization from national authorities.

Quick reference data — The Quick reference data is an extract of the product data given in the Limiting values and Characteristics sections of this document, and as such is not complete, exhaustive or legally binding.

Non-automotive qualified products — Unless this data sheet expressly states that this specific NXP Semiconductors product is automotive qualified, the product is not suitable for automotive use. It is neither qualified nor tested in accordance with automotive testing or application requirements. NXP Semiconductors accepts no liability for inclusion and/or use of non-automotive qualified products in automotive equipment or applications.

In the event that customer uses the product for design-in and use in automotive applications to automotive specifications and standards, customer (a) shall use the product without NXP Semiconductors' warranty of the

product for such automotive applications, use and specifications, and (b) whenever customer uses the product for automotive applications beyond NXP Semiconductors' specifications such use shall be solely at customer's own risk, and (c) customer fully indemnifies NXP Semiconductors for any liability, damages or failed product claims resulting from customer design and use of the product for automotive applications beyond NXP Semiconductors' standard warranty and NXP Semiconductors' product specifications.

12.4 Trademarks

Notice: All referenced brands, product names, service names and trademarks are the property of their respective owners.

13. Contact information

For more information, please visit: <http://www.nxp.com>

For sales office addresses, please send an email to: salesaddresses@nxp.com

14. Contents

1	Product profile	1
1.1	General description	1
1.2	Features and benefits	1
1.3	Applications	1
1.4	Quick reference data	2
2	Pinning information	2
3	Ordering information	3
4	Marking	3
5	Limiting values	3
6	Thermal characteristics	4
7	Static characteristics	4
8	Dynamic characteristics	5
8.1	Dynamic characteristics for amplifier A	5
8.1.1	Graphics for amplifier A	6
8.1.2	Scattering parameters for amplifier A	10
8.1.3	Noise data for amplifier A	10
8.2	Dynamic characteristics for amplifier B	11
8.2.1	Graphics for amplifier B	12
8.2.2	Scattering parameters for amplifier B	17
8.2.3	Noise data for amplifier B	17
9	Test information	18
10	Package outline	19
11	Revision history	20
12	Legal information	21
12.1	Data sheet status	21
12.2	Definitions	21
12.3	Disclaimers	21
12.4	Trademarks	22
13	Contact information	22
14	Contents	23

Please be aware that important notices concerning this document and the product(s) described herein, have been included in section 'Legal information'.

© NXP B.V. 2011.

All rights reserved.

For more information, please visit: <http://www.nxp.com>

For sales office addresses, please send an email to: salesaddresses@nxp.com

Date of release: 7 September 2011

Document identifier: BF1208