

Full Color SMT Chip LED (3.5 x 3.0 x 1.4 mm)

OVSTRGBFC6

- Red/green/blue + white in single surface mount package
- 8 mm tape on 7" reel compatible with automatic placement equipment
- Each chip individually addressable to provide color on-demand
- ESD protected [± 1 kV, 1 time (200 pF 0 Ω)]

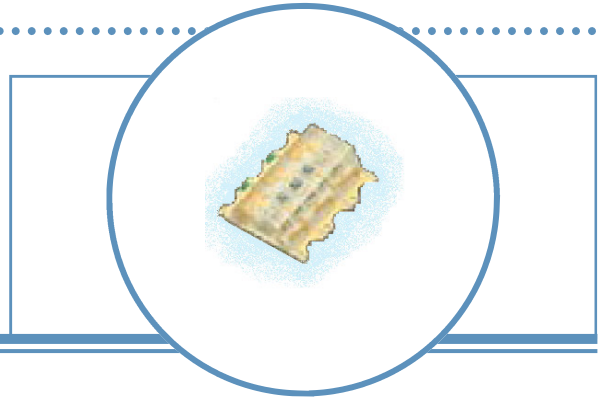

The **OVSTRGBFC6** is a full-color chip LED with multiple viewing angles and the ability to produce all colors of the visible spectrum, plus white. This small package, combined with high-light output, is ideal for miniature applications.

Applications

- Automotive (backlighting in dashboard and switches)
- Telecommunications (indicator and backlighting in telephone and fax)
- Flat backlight (LCDs, membrane switches and symbols)
- Personal/portable appliances (mobile phones, pagers, audio/video players and GPS)

Part Number	Material	Emitted Color	Intensity Typ. mcd	Lens Color
OVSTRGBFC6	AllnGaP/InGaN	Red/Green/Blue	53/165/46	Water Clear

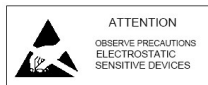
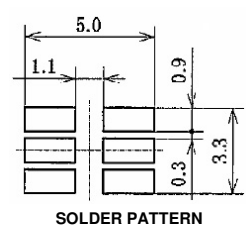
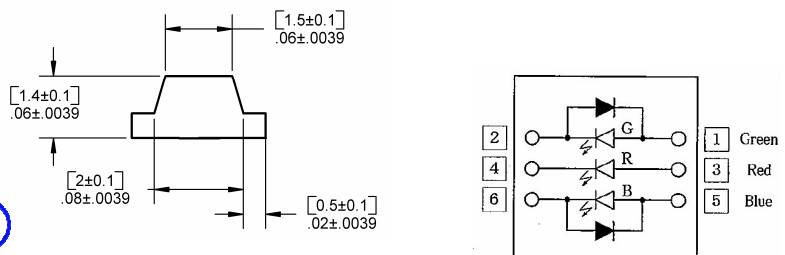
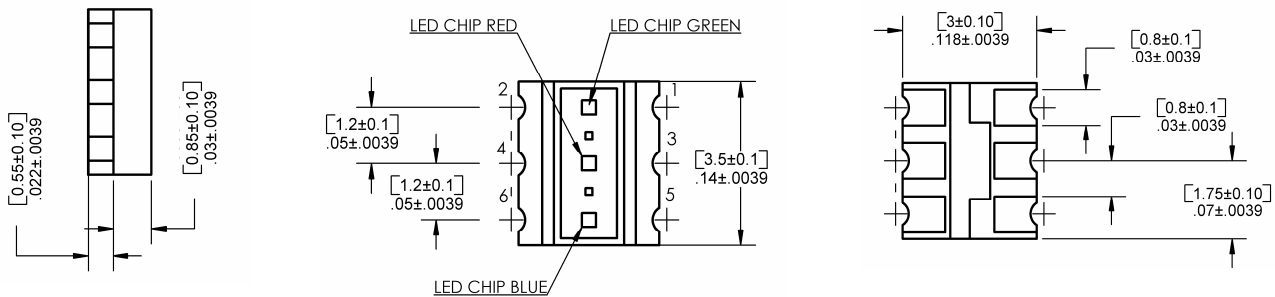

DO NOT LOOK DIRECTLY AT LED WITH UNSHIELDED EYES OR DAMAGE TO RETINA MAY OCCUR.

OPTEK reserves the right to make changes at any time in order to improve design and to supply the best product possible.

Full-Color SMT Chip LED

OVSTRGBFC6



Absolute Maximum Ratings

$T_A = 25^\circ\text{C}$ unless otherwise noted

SYMBOL	PARAMETER	VALUE			UNIT
		RED	GREEN	BLUE	
P_D	Power Dissipation (1 chip on)	68	98	98	mW
I_F	DC Forward Current (1 chip on)	25	25	25	mA
P_D	Power Dissipation (2 or 3 chips on)	22	33	33	mW
I_F	DC Forward Current (2 or 3 chips on)	10	10	10	mA
I_{FP}	Pulsed Forward Current ¹	100	100	100	mA
ΔI_F	DC forward Current Reduction ² ($T_A \geq 40^\circ\text{C}$) (1 chip on)	-0.425			mA/ $^\circ\text{C}$
	DC forward Current Reduction ² ($T_A \geq 40^\circ\text{C}$) (3 chips on)	-0.1			
T_{OPR}	Operating Temperature	-30 ~ +80			$^\circ\text{C}$
T_{STG}	Storage Temperature	-40 ~ +100			$^\circ\text{C}$

Notes:

- Duty $\leq 5\%$, Pulse Width ≤ 1 msec.
- $T_{OPR} = 40 \sim 80^\circ\text{C}$. Use under this condition.

Electrical Characteristics

$T_A = 25^\circ\text{C}$ unless otherwise noted

RED						
SYMBOL	PARAMETER	MIN	TYP	MAX	UNITS	CONDITIONS
V_F	Forward Voltage	----	1.9	2.4	V	$I_F = 20$ mA
I_R	Reverse Current	----	----	100	μA	$V_R = 5$ V
I_V	Luminous Intensity (Axial Direction)	22	----	127	mcd	$I_F = 20$ mA
λ_d	Dominant Wavelength	621	----	631	nm	$I_F = 20$ mA
λ_Δ	Spectral Line Half Width	----	15	----	nm	$I_F = 20$ mA

OPTEK reserves the right to make changes at any time in order to improve design and to supply the best product possible.

Full-Color SMT Chip LED

OVSTRGBFC6



Electrical Characteristics

T_A = 25°C unless otherwise noted

GREEN						
SYMBOL	PARAMETER	MIN	TYP	MAX	UNITS	CONDITIONS
V _{F1}	Forward Voltage	----	3.3	3.9	V	I _F = 20 mA
V _{F2}		2.0	----	----	V	I _F = 5 μA
I _V	Luminous Intensity (Axial Direction)	82	----	372	mcd	I _F = 20 mA
λ _d	Dominant Wavelength	520	----	540	nm	I _F = 20 mA
Δλ	Spectral Line Half Width	----	35	----	nm	I _F = 20 mA

Electrical Characteristics

T_A = 25°C unless otherwise noted

BLUE						
SYMBOL	PARAMETER	MIN	TYP	MAX	UNITS	CONDITIONS
V _{F1}	Forward Voltage	----	3.4	3.9	V	I _F = 20 mA
V _{F2}		2.0	----	----	V	I _F = 5 μA
I _V	Luminous Intensity (Axial Direction)	25	----	101	mcd	I _F = 20 mA
λ _d	Dominant Wavelength	460	----	480	nm	I _F = 20 mA
Δλ	Spectral Line Half Width	----	25	----	nm	I _F = 20 mA

Ranking

I_F = 20 mA

LUMINOUS INTENSITY (mcd)			
RANK	RED	GREEN	BLUE
J	22 ~ 53	82 ~ 165	25 ~ 46
K			46 ~ 101
L		165 ~ 372	25 ~ 46
M	46 ~ 101		
N	53 ~ 127	82 ~ 165	25 ~ 46
P			46 ~ 101
Q		165 ~ 372	25 ~ 46
R			46 ~ 101

OPTEK reserves the right to make changes at any time in order to improve design and to supply the best product possible.

Full-Color SMT Chip LED

OVSTRGBFC6



Reliability Tests

TEST ITEM	STANDARD TEST METHOD ¹	TEST CONDITIONS		FAILURE RATE ^{2, 3}
Operating Test	ED-4701-D-511	1 chip on ⁴	$T_A = 25^\circ\text{C}$, $I_F = 25\text{ mA}$, DC ₂ t = 1000 hours	0/20
		3 chips on ⁴	$T_A = 25^\circ\text{C}$, $I_F = 10\text{ mA}$, DC ₂ t = 1000 hours	0/20
High Temp Storage Test	ED-4701-3-B-111A	$T_A = 100^\circ\text{C}$, t = 1000 hours		0/20
Low Temp Storage Test	ED-4701-3-B-112A	$T_A = 30^\circ\text{C}$, t = 1000 hours		0/20
High Humidity Storage Test	ED-4701-3-B-121A	$T_A = 85^\circ\text{C}$, RH $\geq 85\%$, t = 1000 hours		0/20
High Temp Operating Test	----	1 chip on ⁴	$T_A = 80^\circ\text{C}$, $I_F = 8\text{ mA}$, DC ₂ t = 1000 hours	0/20
High Temp and High Humidity Operating Test	ED-4701-3-B-122A	1 chip on ⁴	$T_A = 60^\circ\text{C}$, RH $\geq 90\%$, t = 1000 hours, $I_F = 16\text{ mA}$, DC	0/20
Temperature Cycle Test	ED-4701-3-B-131A	$T_A = (-30^\circ\text{C}, 30\text{ minutes} \sim 100^\circ\text{C}, 30\text{ minutes})$ x 100 cycles		0/20
Thermal Shock Test	ED-4701-3-B-141A	$T_A = (-40^\circ\text{C}, 5\text{ minutes} \sim 80^\circ\text{C}, 5\text{ minutes})$ x 50 cycles		0/20
Fall Test	----	h = 1 m, maple tree board, 10 times		0/20

Failure Criteria

SYMBOL	ITEM	MIN	MAX	CONDITIONS
V_F	Forward Voltage	----	U.S.L. x 1.1 ⁵	$I_F = 20\text{ mA}$
V_R		2.0	----	$I_F = 5\text{ }\mu\text{A}$
I_R	Reverse Current (red only)	----	100 μA	$V_R = 5\text{ V}$
I_V	Luminous Intensity	L.S.L. x 0.5 ⁶	----	$I_F = 20\text{ mA}$

Notes:

1. Number: EIAJ ("Electronic Industries Association of Japan") standard methods are used.
2. Failure rate is obtained when there is no damage by static electricity.
3. Failure rate evaluated based on "Criteria for Judging the Damage" table.
4. One (1) chip on = electric current only to one color in one LED. Three (3) chips on = electric current to the red, the green and the blue simultaneously.
5. U.S.L.: Upper Standard Level (see maximum values on red, green and blue Electrical tables on pages 2 and 3).
6. L.S.L.: Lower Standard Level (see minimum values on red, green and blue Electrical tables on pages 2 and 3).

OPTEK reserves the right to make changes at any time in order to improve design and to supply the best product possible.

Full-Color SMT Chip LED OVSTRGBFC6

Radiation Patterns

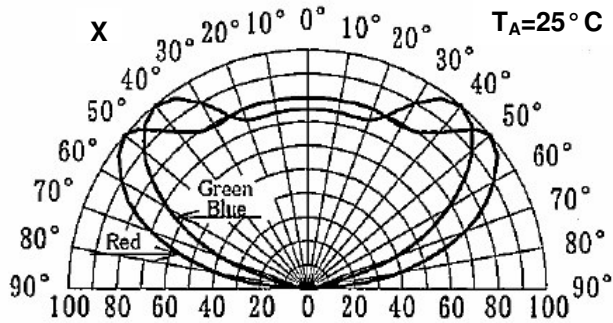

Relative Luminous Intensity

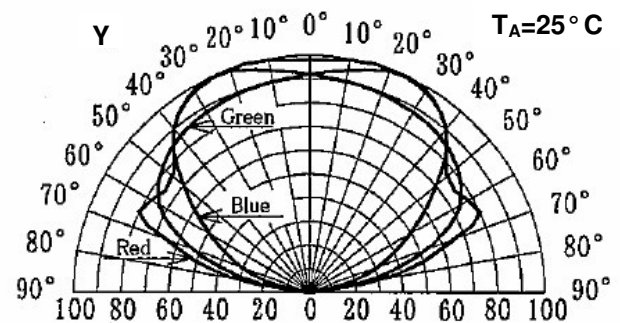

Relative Luminous Intensity

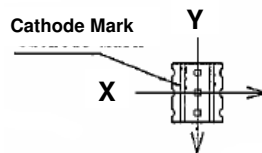

OPTEK reserves the right to make changes at any time in order to improve design and to supply the best product possible.

Typical Electro-Optical Characteristics Curves

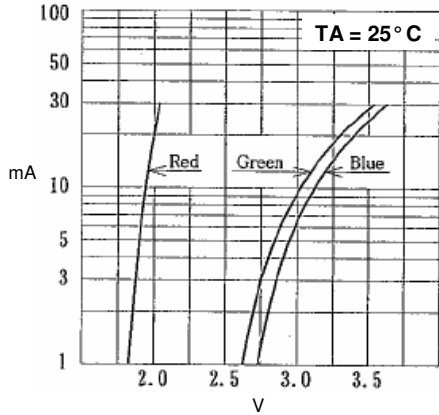

Forward Voltage vs Forward Current

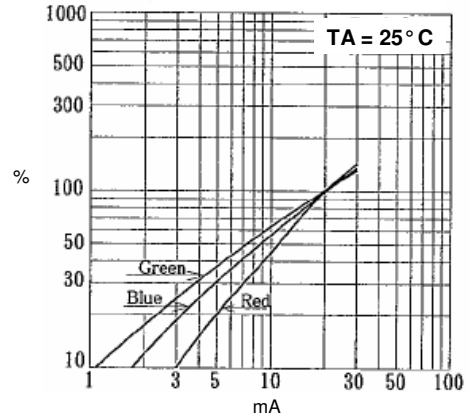

Forward Current vs Relative Luminous Intensity

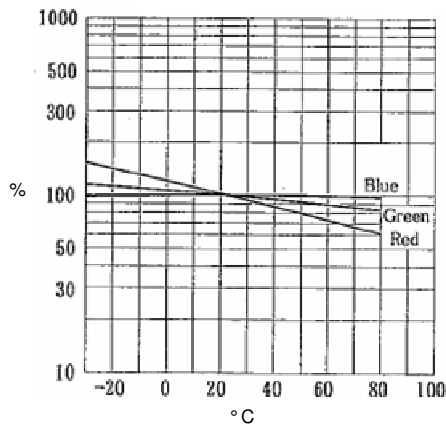

Ambient Temperature vs Relative Luminous Intensity

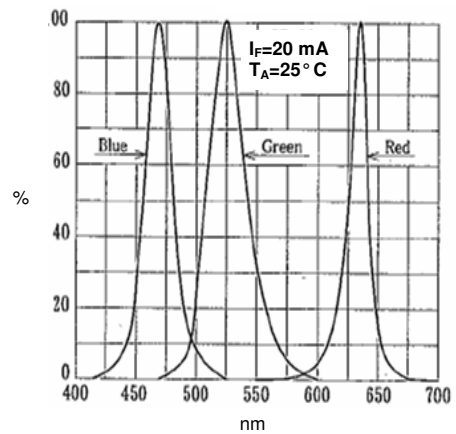

Wavelength vs Relative Intensity

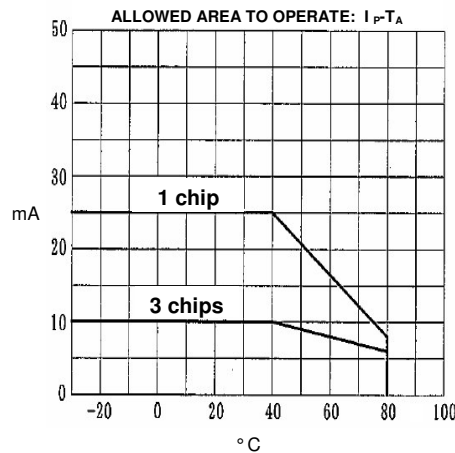

Forward Current vs Ambient Temperature

OPTEK reserves the right to make changes at any time in order to improve design and to supply the best product possible.

Typical Electro-Optical Characteristics Curves

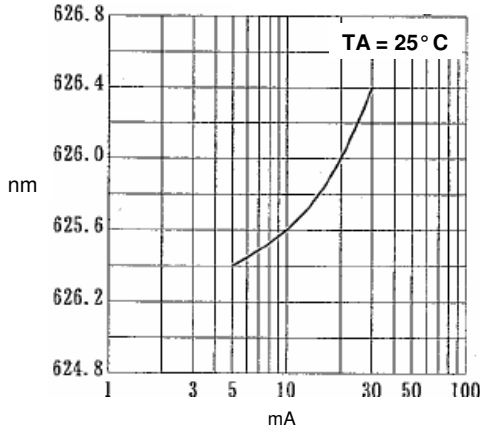

Red: Forward Current vs Dominant Wavelength

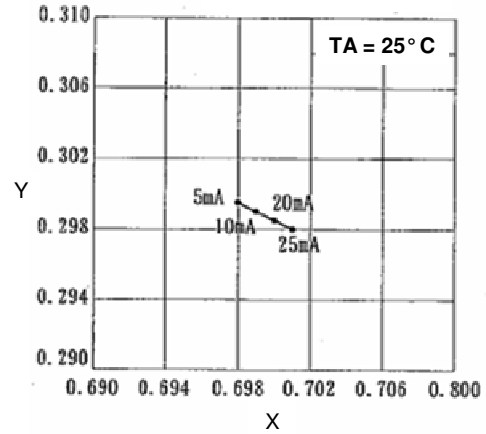

Red: Forward Current vs Chromaticity Diagram

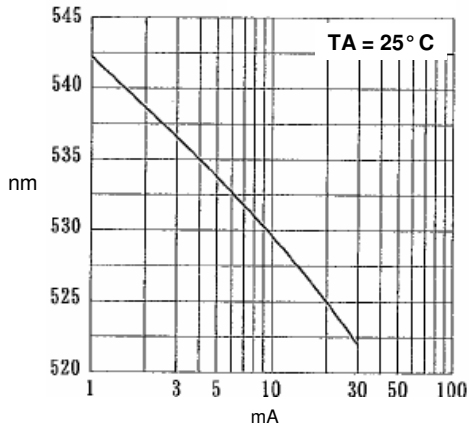

Green: Forward Current vs Dominant Wavelength

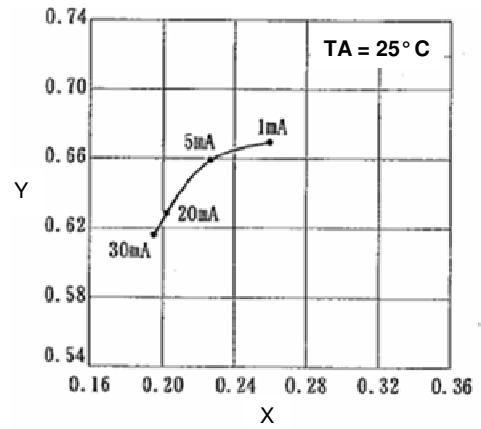

Green: Forward Current vs Chromaticity Diagram

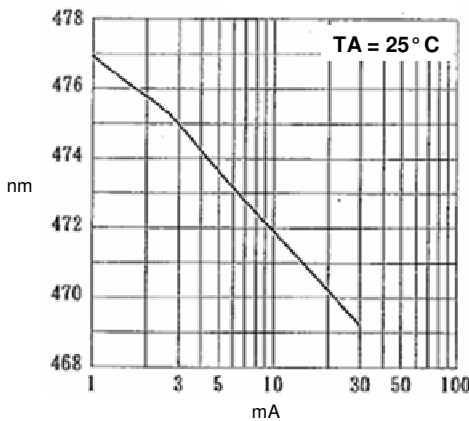

Blue: Forward Current vs Dominant Wavelength

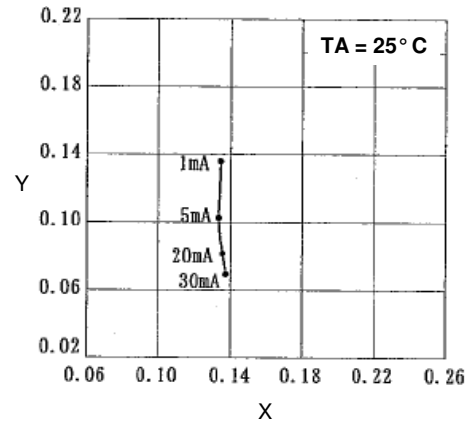

Blue: Forward Current vs Chromaticity Diagram

OPTEK reserves the right to make changes at any time in order to improve design and to supply the best product possible.

Full-Color SMT Chip LED

OVSTRGBFC6

Carrier Tape Dimensions: Loaded quantity 1000 pieces per reel

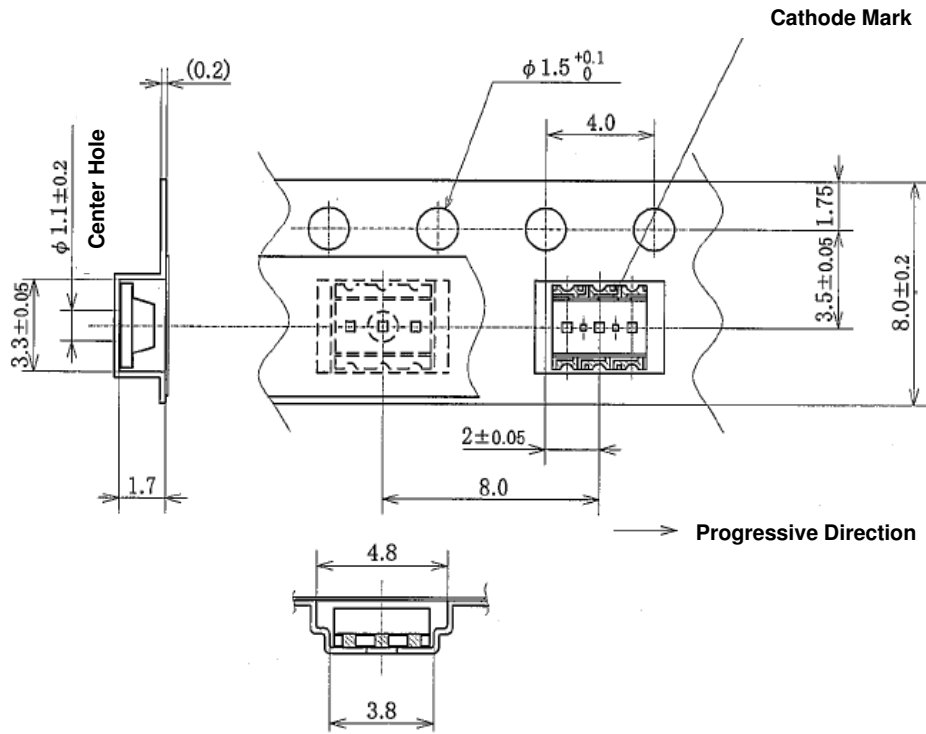
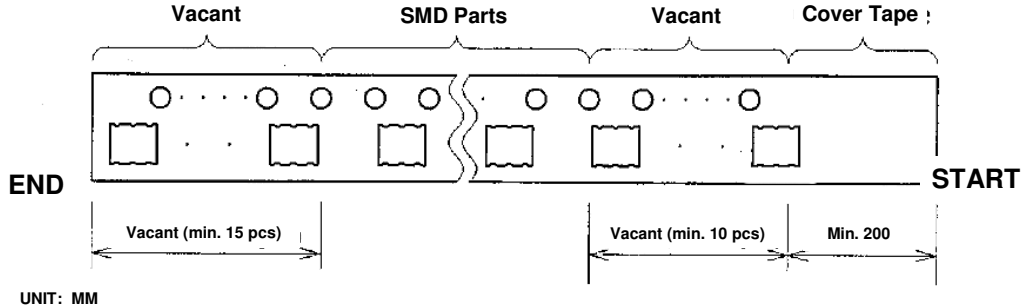

Notes:

1. General tolerance is ± 0.1 .
2. Cover tape peeling-off strength is 0.29 - 0.58 N (10° tear-away angle of the cover tape and the carrier tape).

OPTEK reserves the right to make changes at any time in order to improve design and to supply the best product possible.

Full-Color SMT Chip LED

OVSTRGBFC6

Packing Information: 1000 pieces on 7-inch reel sealed in ESD protected bag

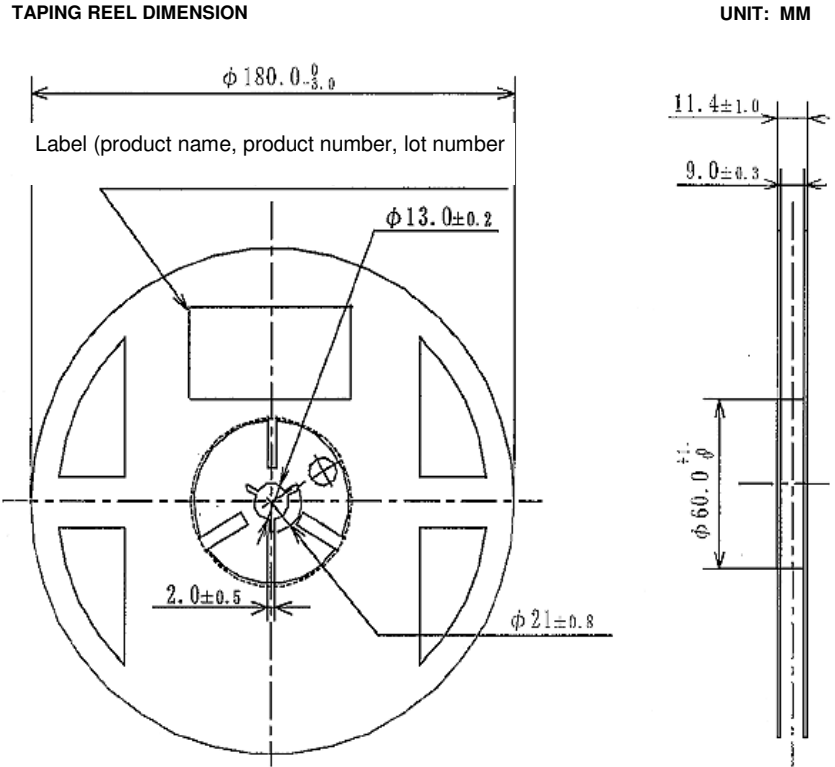

Moisture Resistant Packaging

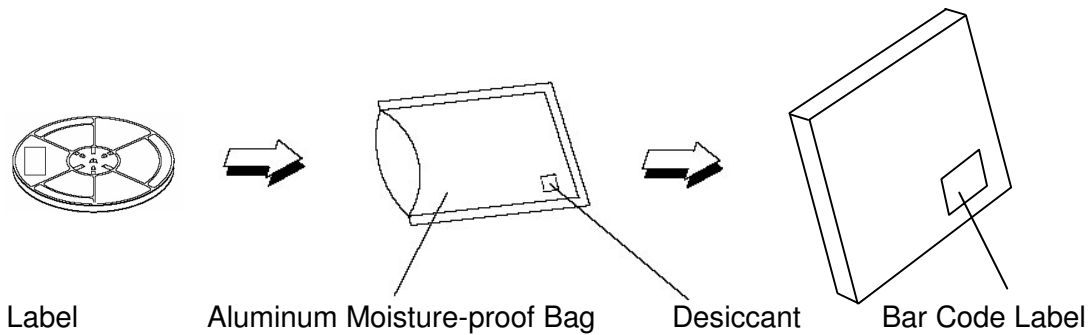

OPTEK reserves the right to make changes at any time in order to improve design and to supply the best product possible.